

AQHA



OFFICIAL HANDBOOK
of RULES *and* REGULATIONS
2016 | 64th EDITION

I AM
AQHA



Life is about putting your passion to work and finding adventure.

Carol Wagner began looking for a new horse a few years ago and ended up with an unbroken four-year-old named Tripl Blackburn King. The aptly nicknamed “Partner” quickly transformed from an uneducated youngster to an eager participant in a unique sport.

Together, Carol and Partner have fallen in love with endurance and competitive trail riding. They are passionate about the trails and can’t wait to see what challenges are around the next corner.

Passion breeds success, and Carol has had her fair share. The pair have won numerous top five year end placings with the Upper Midwest Endurance Competitive Ride Association and were recently the Charles Phillips Versatility Award Reserve Champion.

“This American Quarter Horse is definitely holding his own in a sport where Quarter Horses are not the dominant breed,” said Carol.

Carol and Partner set out looking for adventure and found success.

**Take the adventure of a lifetime
with an American Quarter Horse.**



#AQHAProud • aqha.com

AMERICAN QUARTER HORSE

An American Quarter Horse possesses acceptable pedigree, color and markings, and has been issued a registration certificate by the American Quarter Horse Association. This horse has been bred and developed to have a kind and willing disposition, well-balanced conformation and agile speed. The American Quarter Horse is the world's most versatile breed and is suited for a variety of purposes - from working cattle on ranches to international reining competition. There is an American Quarter Horse for every purpose.

AQHA MISSION STATEMENT

- To record and preserve the pedigrees of the American Quarter Horse, while maintaining the integrity of the breed and welfare of its horses.
- To provide beneficial services for its members that enhance and encourage American Quarter Horse ownership and participation.
- To develop diverse educational programs, material and curriculum that will position AQHA as the leading resource organization in the equine industry.
- To generate growth of AQHA membership via the marketing, promotion, advertising and publicity of the American Quarter Horse.
- To ensure the American Quarter Horse is treated humanely, with dignity, respect and compassion, at all times.

FOREWORD

The American Quarter Horse Association was organized in 1940 to collect, record and preserve the pedigrees of American Quarter Horses. AQHA also serves as an information center for its members and the general public on matters pertaining to shows, races and projects designed to improve the breed and aid the industry, including seeking beneficial legislation for its breeders and all horse owners. AQHA also works to promote horse ownership and to grow markets for American Quarter Horses.

Shows, races and performance events give breeders and exhibitors opportunities to compete for awards and prize money, providing opportunities for breeders to continually strive to improve the breed.

AQHA also publishes *The American Quarter Horse Journal*, the *Q-Racing Journal* and *America's Horse*, which highlight information about horses, horsemen, shows, sales, racing and histories of all-time great horses, and the men and women who bred them, along with ways for breeders, trainers, exhibitors and trail riders to improve their business operations, horsemanship and enjoyment of the horse.

American Quarter Horses continue to be the world's most versatile breed of horse because of their abilities to excel in so many different arenas and because of the continued commitment of American Quarter Horse breeders, directors and staff to providing outstanding programs and services - at the lowest possible fees - of any equine breed registry or membership organization.

THIS RULEBOOK SUPERSEDES ALL PREVIOUS EDITIONS.

THE RULES PUBLISHED HEREIN ARE EFFECTIVE JANUARY 1, 2016 UNLESS OTHERWISE SPECIFIED AT THE TIME OF THEIR ENACTMENT. THESE RULES REMAIN IN EFFECT EXCEPT AS SUPERSEDED BY RULE CHANGES ENACTED BY THE BOARD OF DIRECTORS OR EXECUTIVE COMMITTEE AS PUBLISHED ON AQHA'S WEB SITE AT WWW.AQHA.COM. REFER TO AQHA'S WEBSITE FOR THE MOST UPDATED VERSION OF THE RULES. DIFFERENCES BETWEEN RULES PUBLISHED ON AQHA'S WEBSITE AND THIS HANDBOOK SHALL BE GOVERNED BY THE OFFICIAL RULES PUBLISHED ON AQHA'S WEBSITE.

EVERY ATTEMPT HAS BEEN MADE TO INDICATE RULE CHANGES/MODIFICATIONS BY BOLD LETTERING/UNDERLINING. PLEASE READ RULES APPLICABLE TO YOUR ACTIVITIES IN THEIR ENTIRETY AS CHANGES/MODIFICATIONS MAY HAVE OCCURRED AS COMPARED TO LAST PUBLISHED EDITION.

POLICY STATEMENT

“THE WELFARE OF THE AMERICAN QUARTER HORSE”

AQHA is the world’s largest breed registry and equine recreational organization, with more than 5 million American Quarter Horses registered worldwide and AQHA membership in excess of 265,000. AQHA international headquarters in Amarillo, Texas, issues and maintains the pedigrees and registration records of all American Quarter Horses, and oversees various programs and incentives - including races, shows, recreational activities and supporting sponsorships - that promote America’s oldest distinct breed of horse. AQHA provides beneficial services for its members that enhance and encourage American Quarter Horse ownership and participation, and strives to generate growth of AQHA membership via the marketing, promotion, advertising and publicity of the American Quarter Horse. Furthermore, AQHA actively protects the welfare and integrity of American Quarter Horses, as evidenced by the following Statement of Position:

AQHA STATEMENT OF POSITION

The American Quarter Horse Association’s mission is to record and preserve pedigrees of American Quarter Horses, while maintaining the integrity of the breed. Further, AQHA encourages American Quarter Horse ownership and participation. AQHA actively protects the American Quarter Horse by establishing and strictly enforcing rules that govern every AQHA-approved event in order to reflect the natural ability of the horse. To that end, AQHA is committed to the following beliefs:

- Every American Quarter Horse, all other horses and all animals, shall, at all times, be treated humanely and with dignity, respect and compassion.
- Stringent rules established and enforced by AQHA demand that American Quarter Horse breeders, owners, trainers and exhibitors are continually responsible for the well-being and humane treatment of any American Quarter Horse entrusted to their care.
- Above all, the American Quarter Horse’s welfare is paramount to other considerations, and the continual development of procedures that ensure humane treatment of the breed and of all other horses and all animals involved with AQHA events, and fair competition supersede all other concerns.

AQHA’S DISCLAIMER OF RESPONSIBILITY FOR SAFETY

AQHA does not assume responsibility for safety of participants at the shows or other events it sanctions and responsibility for participant safety remains solely with show management. Show management applies for AQHA approval on a voluntary basis, agreeing to conduct the show according to AQHA rules, which are designed to promote fair competition. Assumption of responsibility for safety by show management is required by AQHA as an express condition to grant the designation “AQHA-approved show.” AQHA’s limited objective is to require, by rule enforcement, a “level playing field” of competition in order that performance of exhibitor and horse can be judged uniformly by competent judges; horses are identified by registration certificate; and horses perform or are exhibited free of prohibited substances that could affect their performance. Safety is a concern of everyone, but AQHA does not assume responsibility for it. AQHA’s limited purpose for sanctioning a show is to promote fair competition.

DISCIPLINARY PROCEDURES

The AQHA Executive Committee is the forum within AQHA that, ini-

tially or ultimately, hears or reviews evidence of alleged violations of rules and regulations by members and/or participants in AQHA-approved events. A member may be disciplined, suspended, fined and/or expelled from AQHA, and any nonmember participant may be denied any or all AQHA privileges.

AQHA rules pertaining to prohibition of drugs, surgical alteration or any inhumane treatment of the horse provide for absolute responsibility for a horse's condition by an exhibitor, trainer, participant and/or the owner, thereby making the exhibitor, participant and/or the owner eligible for possible disciplinary action upon proof of the presence of such prohibited drug by laboratory analysis, existence of surgical alteration or any inhumane treatment of the horse.

ENHANCEMENT OF PENALTY

AQHA reserves the right to independently direct disciplinary action or sanction against individuals coming under its jurisdiction by participation in AQHA-approved shows, contests, race meets or other events. The AQHA Executive Committee may enhance or initiate suspension, fine and/or otherwise penalize offenders of AQHA rules and regulations, and/or those of other jurisdictions; and include owners or lessees who have placed the care and custody of their horses to such offenders.

SPECIFIC AQHA RULES AND POLICIES TO PROMOTE THE WELFARE OF THE AMERICAN QUARTER HORSE

Racing

AQHA expresses concern for the health and welfare of the racing athlete through rules and through financial support of worthy industry initiatives. These include support of a racing surface research project, support of the industry's Racing Medication and Testing Consortium and national movements through Racing Commissioners International for uniform medication rules.

AQHA has adopted the following rules limiting the participation of two-year-olds as referenced in RAC30I.5.

To further increase incentives for racing older horses, AQHA implemented the Bank of America Quarter Horse Racing Challenge, a regional racing program with bonus awards. The Challenge's goal is to increase racing opportunities for older horses. In the Challenge, 83 percent of the purse monies of the races offered are for older horses.

AQHA and the AQHA Racing Council and Committee will continue to seek ways and opportunities to ensure the welfare of the racing American Quarter Horse. The AQHA Racing Council and Committee ensures that rules and policies regarding the welfare of racing American Quarter Horses are continually revised and updated as directed by the AQHA Statement of Position.

Shows

Shows sanctioned as approved events by AQHA are regulated by some of the most strict rules enforced within the equine industry and designed to ensure that the safety and welfare of American Quarter Horses competing in approved events are not jeopardized. A number of rules in this Official Handbook are a testament to the fulfillment of these aims and purposes.

AQHA's stance on unsportsmanlike conduct and/or inhumane treatment of a horse is addressed in VIOLATIONS.

Policy on Controlled Substances and Tail Alteration: AQHA's policies concerning the administration of controlled substances (drugs) are well-documented as being among the most stringent in the equine industry. AQHA began drug testing at AQHA-approved shows in 1973 and was among the first, if not the first, equine breed association to do so. AQHA performs random testing throughout the year. AQHA's policy concerning the administration of controlled substances is outlined in VIOLATIONS. Additionally, AQHA has funded research in an effort to determine techniques for evaluation of altered tails in horses, the results of which were presented to equine veterinarians from the United States in October 1992 at a seminar at Colorado State University entitled, "Techniques for Evaluation of Normal and Altered Tail Function in the Equine Utilizing Physical Examinations and Electrodiagnostics." Some of these same techniques are still utilized by AQHA in random testing at the three World Championship Shows.

AQHA spends more than \$1 million annually to test for evidence of controlled substances and/or tail alteration in horses competing in AQHA-approved events. Beginning in 1993, American Quarter Horses competing in non AQHA-approved events also became subject to testing for controlled substances and evidence of tail alteration.

AQHA's Executive Committee has taken action - including investigation, prosecution, suspension of privileges and/or fines being levied - on all cases where substantial evidence existed of violations of AQHA's controlled substances and tail alteration rules. In 2005, AQHA shows in the United States began collecting a per horse drug testing fee to enhance AQHA's ability to enforce its controlled substance policy.

Humane Treatment

The welfare of American Quarter Horses exhibited in AQHA-approved show events is safeguarded in comprehensive rules throughout this Rulebook that provide for their well-being. AQHA's Executive Committee has taken action - including investigation, prosecution, suspension of privileges and/or fines being levied - on all cases where substantial evidence existed of violations of AQHA's animal welfare rules.

Bits and Equipment

To enhance the humane standards to which American Quarter Horses are subjected for competition and training, uniform guidelines regarding bits and equipment are outlined in VIOLATIONS.

In western classes, horses 5 years old and younger may be shown in a snaffle bit, hackamore, curb bit, half-breed or spade bit. Horses 6 years old and older may only be shown in a curb bit, half-breed or spade bit. Chin straps are required and must meet the approval of the judge, must be at least one-half inch in width, and must lie flat against the jaw of the horse.

Prohibited equipment in western classes include jerklines, tie-downs with bare metal in contact with the horse's head, and tack collars. Prohibited equipment in English classes includes draw reins and roweled spurs. Standing or running martingales are also prohibited except in working hunter, jumping and equitation over fences.

Prohibited training equipment at all AQHA shows includes riding in a curb bit without a curb strap, wire, curbstrap with tacks/rivets or solid metal curb straps no matter how padded, wire cavessons, wire or cable tie-downs, bumper bits, metal bosals no matter how padded, metal lounging hackamore, chambons, headstalls made of metal (even if encased in a protective material), twisted rawhide, or rope

(3/8 inch rope may be used with a slip (gag) or a bonet), running martingale used with curb bits used without rein stops, side reins (direct rein from bit to cinch or surcingle), draw reins attached between or around the front legs.

In roping, speed events, team penning and ranch sorting, western-type equipment must be used. Use of rawhide or mechanical hackamores, or other types of bridles is the choice of the contestant.

In halter, the use of lip chains for all horses is prohibited.

Lameness and Movement

American Quarter Horses are easily identified by their unique conformation that allows the breed to be versatile in a variety of athletic endeavors. The evaluation of lameness is a major factor in judging American Quarter Horses competing in **conformation and** performance events and is subsequently stressed in AQHA's Judges Conferences, conducted throughout the year and designed to educate AQHA's approved judges.

Lameness and movement are further emphasized in the judging of classes at AQHA-approved shows.

The condition and conformation of the horse also is considered. At the discretion of the judge, a horse may be penalized or eliminated from a class "if the horse appears sullen, dull, lethargic, emaciated, drawn or overly tired."

Cattle Classes

In AQHA classes that involve the use of cattle, AQHA strives to safeguard the welfare of the cattle, as well as the welfare of both the horses and riders competing in the class. All AQHA-approved shows are encouraged to have a veterinarian on call and are encouraged to provide proper equipment and medication should accidental injury occur. In both cutting and team penning, an optimum number of cattle are prescribed for the class, and the cattle may not be worked more than once within a go-round. Cattle used in the working cow horse class may only be used once within a go-round. Cattle used in roping events may not be used in other classes. In all heading and heeling classes, cattle shall be protected by horn wraps.

Additional rules in this Rulebook outline specific guidelines within each class regarding proper care and handling of cattle. At the judge's discretion, contestants may be penalized or disqualified.

Speed Events

During the course of a speed event, including barrel racing, pole bending and stake race, contestants may utilize a riding crop to enhance the horse's natural ability to race. However, in all speed events, the judge, at his discretion, "may disqualify a contestant for excessive use of a bat, crop, whip or rope in front of the cinch."

AQHA and its Show Committee will continue to seek ways and opportunities to ensure the welfare of the American Quarter Horses exhibited in AQHA-approved events. The AQHA Show Committee strives to ensure that rules and policies regarding the welfare of American Quarter Horses exhibited in AQHA-approved events are continually revised and updated as directed by the AQHA Statement of Position.

EQUINE RESEARCH

AQHA's Equine Research Committee was established as a means of funding equine research at colleges and universities in an effort to better diagnose, manage and prevent diseases not only in American Quarter Horses, but in all horses. The Equine Research Committee annually allocates more than \$300,000 in support of a diverse range

of research projects related to the health, welfare and utility of the horse, and of importance to the horse owner and horse industry. Funding decisions are based on the project's scientific merit, clinical application and/or potential benefit to the horse and horse industry. Breakthroughs include the prevention, treatment and management of colic; metabolic pathways, genetic inheritance modes, diagnostics and preventive measures for various genetic diseases; pathology and prevention of equine pulmonary disorders; reproductive pathology and disease prevention; as well as other advancements for a wide range of diseases have been accomplished via AQHA's Equine Research Committee.

Research findings are published by AQHA in *The American Quarter Horse Journal* so that AQHA members, owners, breeders, trainers and other participants in the industry may make knowledgeable decisions regarding the health and welfare of all horses.

EDUCATION

Since beginning publication of *The American Quarter Horse Journal* in 1948, AQHA has made an ongoing commitment to educate owners concerning the health, safety, nutritional, sanitation and shelter needs of American Quarter Horses. *The American Quarter Horse Journal* and *America's Horse*, AQHA's official member publication, provide comprehensive editorial coverage designed to educate and inform horse owners on proper feeding, health care and training matters concerning American Quarter Horses.

AQHA also has spent hundreds of thousands of dollars in producing brochures and other educational materials on such topics as tips on purchasing a horse and equine health. AQHA has produced dozens of educational videos, in cooperation with horse industry experts, that cover humane and correct training techniques for AQHA-approved events. Through more than 30 years on network and online television, AQHA has featured horse health care segments on many episodes in cooperation with expert veterinarians.

AQHA, through its affiliation with trusted manufacturers and Corporate Partners, provides greater accessibility of quality health, nutrition, handling and tack products to its members

SUMMARY

The American Quarter Horse Association works to ensure not only the integrity and welfare of American Quarter Horses, but also the integrity and welfare of the entire horse industry. AQHA continually revises its policies concerning animal welfare via the Public Policy Committee, Alliance Partners and its Animal Welfare Commission. Through these avenues, as well as industry leadership, advisory groups and councils, the American Quarter Horse Association is able to expand upon its proven efforts to safeguard the welfare of American Quarter Horses as outlined by the AQHA Statement of Position.

Corporation Bylaws American Quarter Horse Association

ARTICLE I

Title, Objects, Location, Corporate Seal

Section 1. Title: This Association shall be known as the AMERICAN QUARTER HORSE ASSOCIATION (“AQHA”) and shall at all times be operated and conducted as a non-profit association in accordance with the laws of the State of Texas, providing for such organizations and by which it shall acquire all such rights as granted to associations of this kind.

Section 2. Objects: The purpose of AQHA shall be to collect, record and preserve the pedigrees of American Quarter Horses; to maintain a Stud Book and registry to record the history, breeding, exhibition, and racing of American Quarter Horses; and to stimulate the publicity and improvement of this breed; together with all other matters necessary or convenient to further the interests of the breed.

Section 3. Place of Business: The principal place of business shall be Amarillo, Potter County, Texas, but its members or officers may be residents of any state, country, province or region and business may be carried on at any place convenient to such members or officers, as may be participating.

Section 4. Corporate Seal: The seal of AQHA shall be in the charge of the Executive Vice President and shall be in the form impressed hereon immediately below.



ARTICLE II

Members

Section 1. Members of AQHA shall be admitted, retained and expelled in accordance with such rules and regulations as the Board of Directors may, from time to time, adopt. In all matters governed by the vote of the members, each member in good standing who has been a member for at least sixty (60) days per AQHA records shall be entitled to one (1) vote.

Section 2. The annual meeting of the members shall be held at such time and place as may be established by the Board of Directors for the purpose of electing Directors and for the transaction of such other business as may be brought before the meeting (“Annual Membership Meeting”). Unless otherwise established by the Board of Directors, the Annual Membership Meeting shall be held at AQHA’s Annual Convention and shall consist of two (2) sessions hereinafter referred to as the “Membership General Meeting” and the “Membership Business Meeting”.

Section 3. Special Meetings of members may be held at such time and place as may be designated in the notice, whenever called in writing by direction of the President with the advice and majority vote of the Executive Committee or by a majority of the Board of Directors, or by notice signed by not less than 20 percent of the members then in

good standing.

Notice of each Special Meeting, indicating briefly the object or objects thereof, shall be given in the same manner as provided with respect to notice of Annual Membership Meetings.

Section 4. Prior notice to members of any Annual Membership Meeting or Special Meeting of members may be given by written notice to members sent at least thirty (30) days prior to the scheduled meeting by: (1) separate written notice, (2) notice contained in a conspicuous place in a regularly published official membership communication (including, but not limited to *America's Horse* and/or *The American Quarter Horse Journal*, or (3) as otherwise allowed by the law. Notice shall be deemed to be delivered when the separate written notice or the membership communication containing such notice shall be deposited in the United States mail, addressed to the member at the current address as it appears on the records of AQHA, with postage pre-paid. If notice is delivered by means other than mail, such notice shall be deemed delivered at the time such notice is published or transmitted in a manner allowed by law.

Section 5. At any meeting of the members held in accordance with the foregoing provisions as to notice, the members attending such meeting shall constitute a quorum for all purposes unless the representation of a larger number should be required by law. To exercise voting privileges, a member must be physically present at a meeting, which privilege cannot be delegated by proxy. Membership shall have the right to elect Elected Directors and propose modifications and make recommendations to Board of Directors.

Section 6. Any officer of AQHA may call the meeting of the members to order and may act as chairman of such meeting, precedence being given as follows: President, First Vice President, Second Vice President, Executive Vice President and the Treasurer. In the absence of all such officers, members present may elect a chairman.

The Executive Vice President of AQHA shall act as secretary of all meetings of the members, but in his absence, the Directors may appoint any person to act as secretary of the meeting.

Section 7. Whenever in these Bylaws the term member or members shall be used, unless otherwise specified, it shall mean a member or members in good standing having the right to vote.

ARTICLE III

Directors

Section 1. The business and property of AQHA shall be managed and controlled by the Board of Directors and an Executive Committee hereinafter created and empowered.

The Board of Directors shall be comprised of members of annually Elected Directors, Past AQHA Presidents, Directors Emeritus, Directors-at-Large, Honorary Vice Presidents, International District Directors and Appointed International Directors.

Elected Directors, Past AQHA Presidents, Directors Emeritus, Directors-at-Large, Honorary Vice Presidents and International District Directors shall have the privilege of attending all Board of Directors meetings, taking part in discussion and voting, unless otherwise specified herein. Appointed International Directors shall not have voting privileges but may attend all Board of Directors meetings and take part in discussion.

It is a privilege, not a right to serve on the Board of Directors. Throughout his/her tenure, a Director must (1) remain an AQHA member in good standing, (2) adhere to AQHA rules and regulations per-

taining to membership conduct, (3) conduct themselves in an exemplary manner such as to favorably reflect on the Board of Directors and AQHA, and (4) refrain from conduct that is detrimental to the interest of AQHA, its programs, policies, objectives and harmonious relationship of its members. A Director's conduct is subject to continual review, and a Director's service on the Board of Directors may be terminated or rejected by the Board of Directors with or without notice and formal hearing.

(a) Elected Directors. (1) The number of Elected Director(s) that may represent a Representative District shall be determined by an Annual Allocation formula which is based on the number of active AQHA numbered and appendix horses ("Active Horse Population") within such a Representative District as of September 30 of the preceding year.

(2) In accordance with the Annual Allocation formula, the number of Elected Directors will be frozen permanently at 150, with a tolerance of two percent (2%) to allow for mathematical variances. (Elected Director Number").

(3) The term "Horse Population Factor" shall mean the total Active Horse Population in the world divided by the Elected Director Number. For example, if, for a particular year, the total Active Horse Population in the world on September 30th is 3,000,000 and the Elected Director Number is 150, the Horse Population Factor would be 20,000 (3,000,000 divided by 150).

(4) A Representative District is entitled to be represented by Elected Director(s) who are annually nominated and elected as provided herein.

(5) Each U.S. state, Canadian province or international country having a major portion of the Horse Population Factor shall constitute a Representative District.

(6) By majority vote of the Executive Committee, where a U.S. state or Canadian province has less than a major portion of the Horse Population Factor, it may be grouped with one or more other U.S. states or Canadian provinces to form a Representative District that has at least a major portion of the Horse Population Factor.

(7) Alternatively and by majority vote of the Executive Committee, if a U.S. state or Canadian province has less than a major portion of the Horse Population Factor, it may be:

(i) grouped with one or more other U.S. states or Canadian provinces to form a Representative District having at least 25% of the Horse Population Factor; or

(ii) allowed to stand alone to form a Representative District having at least 25% of the Horse Population Factor.

(8) Where an international country has less than a major portion of the Horse Population Factor but has at least 25% of the Horse Population Factor, it shall constitute a Representative District.

(9) The Elected Director position gained as a result of the application of subsections (a)(7) or (a)(8) above shall not be counted toward the Elected Director Number referenced in (a)(2) above.

(10) A Representative District, after gaining its initial Elected Director, shall be entitled to be represented by an additional Elected Director when the Representative District reaches an Active Horse Population equal to or greater than 1.5 times the Horse Population Factor. Thereafter, the Active Horse Population a Representative District must have to gain additional Elected Directors is equal to the following formula: ((Current number of Elected Directors plus .5) multi-

plied by the Horse Population Factor).

- (11) A Representative District shall not lose an Elected Director Position unless, for three (3) consecutive years ("Grace Period"), its Active Horse Population remains below the Active Horse Population number otherwise required for the Representative District to maintain its current number of Elected Directors. During the three (3) year Grace Period, the following shall apply:
- (i) the Elected Director Position that would have otherwise been lost due to a decline in Active Horse Population shall not be counted towards the Elected Director Number; and
 - (ii) vacancies created by elevations of Elected Directors shall not be filled.
- (12) Each Elected Director shall be domiciled in the Representative District which he/she represents by actual residence therein, having the intent to make it his/her permanent home. To be eligible for election and to serve on the Board of Directors, an individual shall have been a member in good standing of AQHA for three consecutive and uninterrupted years immediately previous to nomination. Elected Directors shall serve for a period of one year and until the general election of Elected Directors at the next Membership Business Meeting.
- (13) The Nominations and Credentials Committee shall meet before the Membership Business Meeting to give members or representatives from state, country, provincial or regional organizations an opportunity to present credentials of individuals for nomination and election to the Board as Elected Directors.
- (14) In order for the Nominations and Credentials Committee to consider a nomination of an individual, written credentials must be received by the office of the Executive Vice President on or before February 1 of the year that such credentials are to be reviewed by the Nominations and Credentials Committee. Such filing deadline may be extended by the Executive Committee upon finding of extraordinary circumstances.
- (15) In addition to other relevant matters concerning the individual under consideration, the Nominations and Credentials Committee will evaluate candidates according to criteria established by the Executive Committee.
- (16) At the Membership Business Meeting, the Chairman of the Nominations and Credentials Committee will present the Nominations and Credentials Committee's slate of nominations for Elected Directors, and thereafter, nominations from the floor will be received by the President. To be eligible for nomination for Elected Director from the floor at the Membership Business Meeting, an individual's membership credentials must have previously been presented to the Nomination and Credentials Committee as set forth above. Nominations received from the floor will be received only in opposition to a particular individual, and not in opposition to the total slate for a particular state, country, province or region. At the close of nominations, the President will conduct the election.
- (b) Past Presidents.** All Past Presidents of AQHA shall have lifetime tenure on the Board of Directors;
- (c) Directors Emeritus.** The Board of Directors shall contain a category of Director Emeritus, in recognition of the individual who has, in the past, served AQHA faithfully as an Elected Director, International District Director or Appointed International Director, which category shall be designated with lifetime tenure, on the fol-

lowing basis: The individual who has reached the age of 65 years, having served ten (10) cumulative years as an Elected Director, International District Director or Appointed International Director. Upon reaching his/her 65th birthday, he/she will continue as an Elected Director, International District Director or Appointed International Director until the next Annual Membership Meeting, whereupon he/she will automatically be elevated to Director Emeritus, thereby creating a vacancy to be filled by either the (1) election of an Elected Director or International District Director in his/her Representative District or International District subject to the Annual Allocation or (2) the appointment of an Appointed International Director subject to Article III Section I(f). Directors Emeritus will be awarded life membership in AQHA.

(d) Directors-at-Large. An individual who has served fifteen (15) cumulative terms as an Elected Director, International District Director or Appointed International Director, at the expiration of the fifteenth term, shall automatically receive designation as "Director-at-Large," and serve with lifetime tenure on the Board of Directors, thereby, creating a vacancy to be filled by either the (1) election of an Elected Director or International District Director in his/her Representative District or International District subject to the Annual Allocation or (2) appointment of an Appointed International Director subject to Article III Section I(f).

(e) Honorary Vice President. The Board of Directors shall contain a category of Honorary Vice President in recognition of individuals who merit such honor by reason of distinguished service to AQHA. All Honorary Vice Presidents of AQHA shall have lifetime tenure on the Board of Directors.

The Nominations and Credentials Committee shall meet before the Membership Business Meeting to give members or representatives from state, country, provincial or regional organizations an opportunity to present credentials of individuals for nomination and election as an Honorary Vice President.

In order for the Nominations and Credentials Committee to consider a nomination of an individual for Honorary Vice President, written credentials shall be received by the office of the Executive Vice President on or before January 1 of the year that such credentials are to be reviewed by the Nominations and Credentials Committee. Such filing deadline may be extended by the Executive Committee upon finding of extraordinary circumstances.

In addition to other relevant matters concerning the individual under consideration, the Nominations and Credentials Committee will evaluate Honorary Vice President candidate(s) according to criteria established by the Executive Committee.

At the Membership Business Meeting, the Chairman of the Nominations and Credentials Committee will present the Nominations and Credentials Committee's slate of nomination(s), if any, for Honorary Vice President(s). Nomination(s) for Honorary Vice President(s) will not be received from the floor. After presentation of the Nominations and Credentials Committee's slate of nomination(s) for Honorary Vice President, the President will conduct the election.

(f) International Directors. Each officially recognized international affiliate shall appoint one Appointed International Director. The current president of the international affiliate shall certify in writing to AQHA's Executive Vice President his/her board's appointment to serve as the Appointed International Director at least thirty (30) days prior to the

annual meeting of the Board of Directors. Appointed International Directors shall be in addition to an international country's Elected Director(s), if any, specified in Article III Section I(a) above. Appointed International Directors shall be domiciled in the country that his/her international affiliate represents by actual residence therein, having the intent to make it his/her permanent home. To be eligible to become an Appointed International Director, an individual shall be a member in good standing of AQHA.

Depending upon which international affiliate an Appointed International Director represents, an Appointed International Director shall represent one of the following International Districts: (1) Europe; (2) Mexico, South and Central America; or (3) Oceania and others.

At the Annual Convention each International District shall nominate and elect International District Director(s) to represent and vote for their International District during the Board of Directors meetings. The number of International District Director(s) that may represent an International District shall be determined by an International Annual Allocation formula. The International Annual Allocation formula is based on the number of active AQHA numbered and appendix horses as of September 30 of the preceding year in the International District discounted to an extent by the number of active AQHA numbered and appendix horses in Representative District(s) within the International District as of September 30 of the preceding year. International District Directors shall serve for a period of one year and until the general election of Directors at the next annual Membership Business Meeting.

International District Directors and Appointed International Directors shall serve on the International Committee during their term.

(g) Any Elected Director or International District Director who is absent for two (2) consecutive times from the General Board Meeting and New Board Meeting at AQHA's Annual Convention is automatically removed as a Director without further action, upon his/her second absence, making available for his/her District a vacancy to be filled by regular election of an individual who will represent that District's interests at AQHA's Annual Convention and Board of Directors meetings. Failure to attend either the General Board Meeting or the New Board Meeting at an AQHA Annual Convention shall be considered an absence. However, failure to attend both the General Board Meeting and the New Board Meeting at an AQHA Annual Convention shall only be considered one (1) absence. Absences shall be evidenced by roll call at both the General Board Meeting and the New Board Meeting.

Any Director Emeritus, Director-At-Large or Honorary Vice President who is absent for **three (3)** consecutive times from the General Board Meeting and the New Board Meeting at AQHA's Annual Convention shall automatically lose their Board of Director voting privilege without further action, upon his/her **third** absence. Failure to attend either the General Board Meeting or the New Board Meeting at an AQHA Annual Convention shall be considered an absence. However, failure to attend both the General Board Meeting and the New Board Meeting at an AQHA Annual Convention shall only be considered one (1) absence. Absences shall be evidenced by roll call at both the General Board Meeting and the New Board Meeting. Any Director Emeritus, Director-At-Large or Honorary Vice President who loses their voting privilege as a result of this provi-

sion shall nevertheless have the privilege of attending all meetings of the Board of Directors and take part in discussions. Any Director Emeritus, Director-At-Large or Honorary Vice President who loses their voting privilege as a result of this provision **shall be placed on an honorary board list and** may request to have their voting privilege reinstated by requesting such reinstatement to the Executive Committee.

(h) In accordance with AQHA's mission statement, Elected Directors, Appointed International Directors and International District Directors are expected to assist in the provision of beneficial services for its members. These services should enhance and encourage American Quarter Horse ownership and participation through Director availability and visibility to their respective state, province, country and/or affiliate association. To establish and improve communications between AQHA and its members, Elected Directors, Appointed International Directors and International District Directors shall, during the term of his/her directorship, be a member in good standing of their respective state, province or international affiliate association(s), failure of which shall be reviewed by the Nomination and Credentials Committee. Furthermore, each Elected Director and International District Director should be encouraged to submit a yearly report on the status of the industry in their respective state, province and/or country to aid AQHA in addressing and implementing the needs for members.

(i) All Directors in any of the aforementioned Director categories agree to abide by AQHA policies and guidelines designed to assist AQHA in complying with state, federal, or other applicable law.

Section 2. In case of any vacancy in the Board of Directors by death, resignation, disqualification, increase in number or other cause, the President, with the advice and majority vote of the Executive Committee, may appoint a qualified successor to serve until the next general election of Directors at the Membership Business Meeting.

Section 3. The annual meeting of the Board of Directors ("Annual Board Meeting") shall be held in conjunction with the Annual Membership Meeting. Unless otherwise established by the Board of Directors, the Annual Board Meeting shall consist of two (2) sessions hereinafter referred to as the "General Board Meeting" and the "New Board Meeting". The General Board Meeting shall be immediately following the Membership General Meeting. The New Board Meeting shall be immediately following the Membership Business Meeting. Notice of the Annual Board Meeting shall be given in the same manner set forth in Article II Section 2 above.

Section 4. Special Meetings of the Board of Directors shall be held whenever called by the President with the advice and majority vote of the Executive Committee or by two-thirds of the voting Directors.

The Executive Vice President shall give notice of each Special Meeting to each Director by mailing, telephoning, electronically communicating (or by any other means allowed by law) such notice at least 15 days before the meeting, but such notice may be waived by any Director. Unless otherwise indicated in the notice thereof, any and all business may be transacted at a Special Meeting.

Any meeting at which every Director may be present, even though without any notice, any business may be transacted.

Section 5. A majority of the number of Directors present shall constitute a quorum for the transaction of business, but if at any meeting of the Board there may be less than a quorum present, a majority of

those present may adjourn the meeting from time to time until a quorum shall be present. To exercise voting privileges, a Director must be physically present at a meeting, which privilege cannot be delegated by proxy.

Section 6. At meetings of the Board of Directors, business shall be transacted in such order as the Board of Directors may determine.

Section 7. At the New Board Meeting, the Board shall elect officers of AQHA.

Section 8. Except as otherwise provided herein, the Bylaws and the rules and regulations pertaining to the registration of horses shall be subject to change only by the Board of Directors.

The Board of Directors shall have the power and authority to make, amend, repeal and enforce such rules and regulations, not contrary to law or the Certificate of Incorporation or these Bylaws, as they may deem expedient concerning the conduct, management and activities of AQHA, the admission, classification, qualification, suspension and expulsion of members, removal of officers, the rules and regulations governing the procedure of such suspension and expulsion and removal, the fixing and collecting of dues and fees, regulations regarding maintaining the stud book, registration, expenditures of money, auditing of books and records, awarding of championships, conducting of shows, contests, exhibitions, races, sales and social functions, creation of committees and other details relating to the general purposes of AQHA, all, however, subject to the right of the membership to propose revisions or amendments and make recommendations to the Board of Directors regarding such matters at any regular or special meeting of the members, provided the notice requirements set forth in this Rulebook have been met.

ARTICLE IV

Executive Committee

Section 1. There is hereby created an Executive Committee consisting of the President, First Vice President, Second Vice President and two additional members elected by the membership of the Board of Directors at the New Board Meeting, each for a term of one year and until the selection and qualification of his successor.

Section 2. No officer or member of the Executive Committee may serve on the Executive Committee in excess of five consecutive years.

Section 3. The President with the advice and majority vote of the Executive Committee shall fill all vacancies in the Executive Committee occurring between annual conventions of AQHA.

Section 4. The Executive Committee shall meet whenever and wherever called by direction of the President or two members of the Executive Committee acting jointly, of which meeting the Executive Vice President shall give 10 days' written notice, but such notice may be waived by any member.

Section 5. The Executive Committee may act, without convening in meeting, by written resolution signed by all members thereof and duly entered in AQHA records. At all meetings of the Executive Committee, three members shall constitute a quorum.

Section 6. All powers of the Board of Directors, except the power to change any bylaws and any rules and regulations pertaining to registration of horses, be and are vested in the Executive Committee.

Section 7. All vacancies in the elective and appointed offices of AQHA shall be filled by the Executive Committee for the unexpired term and those so appointed shall serve until the election and acceptance of their duly qualified successors.

Section 8. In order to be eligible to be nominated (or appointed in the case of a vacancy) to serve on the Executive Committee, an individual must, at the time of nomination (or appointment in case of a vacancy), be one of the following: (a) an Elected Director with voting privileges for three consecutive years immediately prior to nomination or appointment; (b) a Director Emeritus, with voting privileges for three consecutive years immediately prior to nomination or appointment; (c) a Director-at-Large with voting privileges for three consecutive years immediately prior to nomination or appointment; (d) an International District Director, with voting privileges for three consecutive years immediately prior to nomination or appointment; (e) Honorary Vice President so long as he/she served as a Director with voting privileges for three years prior to being elected or elevated to Honorary Vice President and has maintained his/her voting privileges for three consecutive years immediately prior to nomination or appointment.

Section 9. (a) At the New Board Meeting of the annual convention, the Board of Directors shall elect an Executive Committee consisting of a President, First Vice President, Second Vice President and two additional members.

(b) Prior to such election, a committee chaired by the newest Past President and composed of Past Presidents registered with and attending the annual convention shall present a slate of nominations for the Executive Committee positions described above to the Board of Directors for its consideration and vote.

(c) After such slate has been presented to the Board of Directors, the President will open the meeting for additional nominations, if any, from the floor. Nominations received from the floor will be received only in opposition to a particular individual, and not in opposition to the total slate.

(d) In order for a candidate not currently on the Executive Committee to be eligible to be nominated by the committee of Past Presidents or nominated from the floor, the following requirements must be met:

(i) on or before November 1 of the year prior to the election, the Executive Vice President must receive the candidate's written resume and a written nomination from a voting Director; and

(ii) the candidate must have personally appeared for an interview before the committee of Past Presidents at the annual convention prior to the election.

(e) 30 days prior to the election, the Executive Vice President shall:

(i) forward to the Past Presidents the resumes and nominations referenced in (d)(i) above; and

(ii) provide notice to the Board of Directors regarding the candidates meeting the requirements in (d)(i) above. Such notice shall contain information regarding the candidates' names, residences (city/state), and number of years of service on the AQHA Board of Directors.

(f) The Past Presidents shall annually interview all of those candidates who meet the requirement in (d)(i) above.

(g) At the close of nominations, the President will conduct the election, either by voice vote, show of hands or secret ballot as a majority of the Board of Directors directs.

(h) In the event an individual is nominated in opposition to and is elected over a current Executive Committee member, the newly

elected individual will fill the lowest Executive Committee office while current Executive Committee members, if re-elected, will graduate to the next highest Executive Committee position.

ARTICLE V

Elective Officers & Duties

Section 1. Officers: The officers of AQHA shall be the President, First Vice President, Second Vice President and such other officers as may be authorized from time to time by the Board of Directors, who shall be elected by the Board of Directors. Such officers shall hold office for the period of one year and until their successors are elected and qualified. None of said officers may succeed themselves in office.

Section 2. President: The President shall be the chief executive officer of AQHA and shall preside at all meetings of the Board of Directors. The President shall see that the bylaws, rules and regulations of AQHA are enforced, and shall perform all other duties that may be prescribed from time to time by the Board of Directors. The President shall be ex officio member of all committees.

Section 3. First Vice President: In the absence of the President, the First Vice President, and in the First Vice President's absence, the Second Vice President, shall have the powers and perform the duties of the President and such other duties as may be prescribed by the Board of Directors.

ARTICLE VI

Executive Vice President & Treasurer

Section 1. In addition to the officers named in Article V, Section 1, there shall be the appointive offices of Executive Vice President and Treasurer of AQHA. These offices shall be filled by the Executive Committee by appointment of qualified individuals, the term of such appointment to be for a period of no greater than three years, with provision for termination of appointment for cause, which appointment may be renewed by the Executive Committee for successive three-year periods. Other provisions of said appointment, such as salary, shall be on such terms as the Executive Committee, at its discretion, may determine. The offices of Executive Vice President and Treasurer may be held by the same person.

Section 2. Duties of Executive Vice President and Treasurer

(a) Executive Vice President: The Executive Vice President is the chief operating officer of AQHA, and, pursuant to direction of the Executive Committee, shall implement the actions, decisions and directions of the Board of Directors and Executive Committee. The Executive Vice President shall be ex officio secretary of all committees appointed by the President or Board of Directors. The Executive Vice President shall make a report of his office to the Board of Directors when demanded and to the membership at the Annual Membership Meeting, and shall perform such other duties as may be prescribed by the Board of Directors from time to time.

(b) Treasurer: The Treasurer is the chief financial officer of AQHA, and, pursuant to direction of the Executive Committee, shall implement the actions, decisions and directions of the Board of Directors and Executive Committee. The Treasurer shall account for the financial condition of AQHA by presenting an independent audit of AQHA accounts at each Annual Membership Meeting and to the Board of Directors when demanded. Also, the Treasurer shall submit to the Executive Committee, at the first meeting following the Annual Membership Meeting, a detailed budget of the proposed and anticipated expenditures for the current fiscal year of AQHA. Upon

approval of this said budget, or its modification, it becomes binding upon the officers of AQHA and cannot be exceeded in the total amount set forth by more than 10 percent without a majority vote of the Executive Committee.

Section 3. Surety Bonds: The Executive Vice President and the Treasurer and all other officers or employees of AQHA who may handle any funds of AQHA shall give a surety bond to be furnished at the expense of AQHA for the faithful discharge of his or her duties, if so required by the Executive Committee.

Section 4. Auditing of Accounts: AQHA shall conduct its affairs on the fiscal year basis, to begin October 1 and end September 30. An annual independent audit of the accounts of AQHA shall be made by a certified public accountant at the close of each fiscal year and shall be reported at the next Annual Membership Meeting following the close of such fiscal year. Such accountant shall be a disinterested person and not a member of AQHA.

ARTICLE VII

Amendments

Section 1. The Board of Directors shall have the power to make, amend and repeal the bylaws of AQHA by vote of the majority of the Directors at any regular or special meeting of the Board, subject to the right of the members to propose revisions or amendments and make recommendations to the Board of Directors regarding any such bylaws in the same manner as provided in Article III, Section 8.

Section 2. To be eligible for consideration by the Board of Directors, a proposed amendment to AQHA's bylaws shall be filed in writing in the office of the Executive Vice President on or before December 31 of the preceding year prior to the Annual Board Meeting or, in the case of any other Board of Directors meeting, at least 60 days prior to such meeting, at which time the proposed amendment is to be considered. The proposed draft shall be promptly sent by the Executive Vice President to each individual eligible to vote at a meeting of Directors. The requirement contained in this section may be suspended by the Board of Directors at any regular or special meeting upon a two-thirds majority vote of eligible voters present, provided a quorum is present.

ARTICLE VIII

Indemnification

Section 1. AQHA shall indemnify, to the fullest extent permitted by these bylaws or the laws of the State of Texas, any person made or threatened to be made a defendant or respondent to any threatened or pending action, suit or proceeding, whether civil, criminal, administrative or investigative, by reason of the fact that the person (a) was or is a director, trustee, officer, employee, member of a committee or member of a council created pursuant to this Rulebook or duly designated by the Executive Committee of AQHA, or (b) was or is serving any other corporation, partnership, joint venture, trust or other business or charitable enterprise as a director, trustee, officer or employee at the specific request of AQHA (hereinafter "indemnitee"). This indemnification is available only if, with respect to the matters made the basis of the underlying action, suit or proceeding, such indemnitee:

- (a) acted in good faith,
- (b) acted in a manner he or she reasonably believed to be in the best interests of AQHA, and
- (c) had no reasonable cause to believe his or her conduct was illegal or unlawful.

The termination of any action, suit or proceeding by judgment, order, settlement, conviction, or on a plea of nolo contendere or its equivalent, shall not of itself, create an irrebuttable presumption that the indemnitee did not meet the requirements set forth above.

This indemnity shall include all usual and customary expenses incurred in defense of or response to the action, suit or proceeding including, attorneys' fees, costs, judgments, fines and amounts paid in settlement that are reasonably incurred by such person in connection with such action, suit or proceeding. The indemnification provided herein shall inure to the benefit of the indemnitee and his or her heirs, executors or administrators and shall not be exclusive of any other rights to which the indemnitee may be entitled by virtue of the laws of the State of Texas, any other Bylaw of AQHA, a written agreement with AQHA, or the vote of the Executive Committee of AQHA.

Notwithstanding the above provisions, a person shall not be indemnified with respect to any action, suit or proceeding filed by or undertaken by the AQHA against the person to whom indemnity would otherwise be available.

Section 2. Conditions Precedent and Rights of AQHA. To preserve this right of indemnity, an indemnitee shall promptly notify AQHA of any actual or threatened action, suit or proceeding, whereupon AQHA shall have the right to, but not the obligation to, assume and direct the defense thereof through attorney(s) selected and paid for by AQHA. If, in its sole discretion, AQHA, by and through its Executive Committee, determines that the failure of the indemnitee to promptly notify AQHA of any actual or threatened action, suit or proceeding prejudiced the rights of AQHA under this provision, it may deny indemnity to the person to whom indemnity would otherwise be available. The selection of attorney(s) will be subject to the consent of the indemnitee, which consent will not be unreasonably withheld. Any settlement, monetary or otherwise, of the action, suit or proceeding shall require the express consent of the Executive Committee of AQHA, and absent such consent, shall be the sole responsibility of the indemnitee.



AS VERSATILE AS THE BREED YOU RELY ON

Pay just \$25 for
2 YEARS of the *Journal*.*

A \$50 VALUE!
*United States residents only

Plus, you'll get exclusive access to the digital version of the *Journal*.

CALL (800) 291-7323 TO SUBSCRIBE TODAY!
Never miss an issue of the industry's most trusted magazine.

JOURNAL
AS VERSATILE AS THE BREED

AQHYA Bylaws

ARTICLE I: Name and Purpose

Section 1. This organization shall be a division of the American Quarter Horse Association (“AQHA”), shall operate within the scope of the bylaws, rules and regulations of AQHA, and shall be named the American Quarter Horse Youth Association (hereafter “AQHYA”).

Section 2. The objectives and purposes of the AQHYA shall be as follows:

- (a) To improve and promote the American Quarter Horse breed.
- (b) To improve and develop the capabilities of youth, both individually and through group participation, in the breeding, raising and exhibition of American Quarter Horses.
- (c) To develop and improve scholarship, leadership and community interest and participation of young equestrians.
- (d) To encourage high moral character, sportsmanship and clean living among all its members.
- (e) To establish a means whereby youth members may work in conjunction with AQHA Youth Activities Committee.
- (f) To create, foster and assist subsidiary youth affiliates composed of members of AQHYA.
- (g) To acquaint youth members and affiliates with the parent organization, AQHA, its structure and functions.
- (h) To use scholarship, leadership, sportsmanship and character to provide a future for our horse.

ARTICLE II: Place of Business

Section 1. The place of business of AQHYA shall be AQHA headquarters in Amarillo, Texas.

Section 2. All correspondence regarding AQHYA shall be directed to the Youth Activities Department of AQHA in Amarillo, Texas.

ARTICLE III: Advisory Board

Section 1. The business and property of AQHYA shall be managed and controlled by the AQHYA Advisory Board (hereafter “Advisory Board”).

Section 2. The Advisory Board shall consist of the AQHA President, the AQHA Executive Vice President, the Chairman of the AQHA Youth Activities Committee, the Manager of Youth Activities and any additional members appointed by the AQHA Executive Committee. This Advisory Board shall consist of at least four adults to assist the AQHA Youth Activities Committee in directing the activities of AQHYA.

Section 3. All actions of AQHYA shall be subject to the Advisory Board’s approval and AQHA Executive Committee’s final approval. The bylaws of AQHYA may be amended by the AQHA Executive Committee.

ARTICLE IV: Membership

Section 1. Classes of Membership: AQHYA shall have the following classes of members:

- (a) Organizational Members, consisting of youth affiliates. The designation youth affiliate shall be defined as one (1) youth association per state, province or international affiliate, acceptable to and approved by the Advisory Board.
- (b) Individual Members, consisting of boys and girls 18 years of age or under. The age of the youth as of January 1 will be the age maintained the entire year.
- (c) Annual individual membership fee is \$15, a three-year membership fee is \$35 and a lifetime youth membership (membership through the 18 year age eligibility) fee is \$50.
- (d) Membership shall allow a youth all privileges of an individual mem-

ber, and in addition, all privileges of an AQHA member except the right to vote at AQHA membership meetings and hold office in AQHA.

- (e) Membership in AQHYA is a privilege, not a right, application for which shall be made by procedures prescribed by AQHYA. Membership, or application therefor, may be terminated or rejected by the Advisory Board for violation of AQHYA or AQHA rules or for cause detrimental to the interest of AQHYA, its programs, policies, objectives and harmonious relationship of its members as determined by the Advisory Board. Unless otherwise specified in AQHYA or AQHA rules, termination of a current membership under this subsection shall be conducted by the Advisory Board under AQHA's disciplinary procedures for notice, hearing and temporary suspension. Rejection of an application shall not be grounds for or entitle an applicant to hearing. The effect of termination or rejection may be denial of the privileges of AQHYA and/or AQHA.

Section 2. Approval of Youth Affiliates: A youth affiliate is eligible to be recognized and considered in good standing with AQHYA and the AQHYA Advisory Board, when the following general conditions are met:

- (a) The youth affiliate must be approved by or affiliated with the recognized state, provincial or international AQHA Affiliate.
- (b) Each youth affiliate shall submit to AQHYA its constitution and bylaws. AQHYA is to be notified of any amendments made to the initially submitted constitution and bylaws.
- (c) On or before March 1 each year, each youth affiliate shall submit to AQHYA a list of its youth affiliate officers, youth affiliate membership, AQHYA Delegates, youth affiliate advisor(s) and AQHYA World Championship Show qualifying guidelines. Youth affiliate officers and AQHYA Delegates must be members in good standing of AQHYA.
- (c) Each organization shall encompass its respective state, province or country in scope. Affiliates with more than 1,500 registered American Quarter Horses are required to have 50 resident youth members to affiliate, affiliates with 500 to 1,500 registered American Quarter Horses are required to have 35 resident youth members to affiliate, and affiliates with fewer than 500 registered American Quarter Horses are required to have 25 resident youth members to affiliate. Notwithstanding the foregoing, an organization found to be representative of a state, province or country may be allowed to affiliate with fewer than the required number of members if they meet the requirements set forth in subsection 2.(c) above and make a formal request for consideration to AQHA by March 1.
- (d) No provision of the youth affiliate constitution is in conflict with the AQHYA or AQHA constitution, bylaws or general rules and regulations.
- (e) Activities are in harmony with the ideals and purposes of AQHYA and AQHA.
- (f) Membership must be open to all youth 18 years of age and under interested in the equestrian lifestyle.

Section 3. Approval of International Youth Associations: An international association, which is recognized by AQHA, is automatically eligible for its youth members to be members of AQHYA, compete in AQHYA activities or AQHA-approved youth events, and for its youth organization to have Delegates with voting privileges on the AQHYA Board of Delegates. To compete in AQHYA activities, AQHA-approved youth events or serve as an AQHYA Delegate, an international member must also be a member of AQHYA by payment of the requisite

membership fee and comply with all rules and regulations. Recognition of an international youth affiliate may be obtained by filing, with AQHYA, an annual written letter of certification by the president of the AQHA-recognized parent international affiliate, certifying:

- (a) the international affiliate has a youth organization with an appointed or elected adult youth advisor or leader responsible for the activities of the youth organization and conduct of its members, either as a division of the international affiliate or separate organization;
- (b) the number of youth members in good standing and, if any intend to compete in AQHYA-approved events, their names, addresses and ages (if not already available through AQHA records), together with any other information requested; and,
- (c) the names of youth elected by the international youth affiliate to represent their respective organization as AQHYA Delegates. Upon request, the president of the recognized parent international affiliate shall provide copies of the youth organization's bylaws, rules and regulations pertaining to its activities, and if a separate organization, governmental certification of its existence and good standing in the international country.

Section 4. Regions of the Organization: The continental United States and Canadian provinces shall be divided into ten (10) regions which shall be designated as shown by the map below. Youth affiliates of international countries will participate in an eleventh region.



ARTICLE V: AQHYA Delegates

Section 1. Delegates: A youth affiliate shall exercise its voting privileges in AQHYA through its Delegates.

Section 2. Annually, each youth affiliate shall elect four (4) Delegates who shall be elected by the individual members in good standing of each youth affiliate.

- (a) **Vacancy:** In the case of any vacancy with the youth affiliate's elected Delegates, the president of the youth affiliate shall appoint a successor to fill the unexpired term of the youth affiliate's Delegate.
- (b) **Meetings:** The regular annual meeting(s) of the AQHYA Board of Delegates shall be held at such time and place as they may be fixed by the Advisory Board Officers for the purpose of electing AQHYA

Officers. Special meetings of the Board of Delegates may be held at such time and place as may be designated in a notice, whenever called in writing by the direction of the Advisory Board.

(c) Notice of Meetings: Written or printed notice of all meetings stating the place, date and hour of meeting, and in the case of a special meeting, the purpose or purposes of which the meeting is being called, shall be delivered not less than 15 days before the date of the meeting, either in person or by mail, at the discretion of the Advisory Board to each recognized youth affiliate entitled to vote at such meeting. If mailed, such notice shall be deemed to be delivered, upon deposit in the United States mail addressed to recognized youth affiliates at their address as it appears on the records of the AQHA/AQHYA, with postage thereon prepaid.

(d) Quorum: A majority of the number of Delegates shall constitute a quorum for the transaction of business, but if at any meeting of the Board of Delegates there may be less than a quorum present, a majority of those present may adjourn the meeting from time to time until a quorum shall be present.

ARTICLE VI : AQHYA Directors

Section 1. Annually, three (3) Directors from each designated region referenced in Article IV Section 4 above shall be elected from and by the Delegates of their respective regions at a regular annual meeting of the Board of Delegates.

Section 2. A candidate for AQHYA Director of a particular region must be a Delegate from his/her affiliate, must remain eligible for AQHYA membership and remain a member in good standing for the duration of his/her term. A youth Director cannot turn 19 before January 1 during the term in which he/she is serving.

Section 3. The duties of an AQHYA Director are to enhance communication and serve as liaison between AQHYA membership of their respective region and the AQHYA Officers.

ARTICLE VII: AQHYA Officers

Section 1. Officers. The officers of AQHYA shall be the president, first vice president, second vice president and two members who shall be elected from and by the Board of Delegates.

Section 2. Such officers shall hold office for a period of one year and until their successors are elected and qualified. AQHYA Officers may be elected to different offices or re-elected to the same office each year with the exception of president. An officer must remain eligible for AQHYA membership and remain a member in good standing for the duration of his/her term. An officer cannot turn 19 before January 1 during the term in which they are serving with the exception of immediate past president.

Section 3. Youth may only accept a nomination for AQHYA Officer if they have previously served as an AQHYA Director for at least one term and have complied with the requirements set forth in the AQHYA Guide to Campaigning.

Section 4. All nominees from the various regions of AQHYA for election to the AQHYA Officers shall be subject to the Advisory Board's prior approval.

Section 5. President: The president shall be the chief executive officer of AQHYA and shall have general supervision of the affairs of AQHYA subject to the direction of the Advisory Board and shall preside at all meetings of the members and the Board of Delegates. The president shall

see that the bylaws, rules and regulations of AQHYA are enforced. The president will serve on the AQHA Youth Activities Committee. In order to be eligible to run for president of AQHYA, a member must have previously served at least one year as an AQHYA Officer. Once the AQHYA Officer has served a term as president, he/she is ineligible to serve in any other electable office, but may be elected to serve as a Director.

Section 6. First Vice President: In the absence of the president, the first vice president shall have the powers and perform the duties of the president. The first vice president shall also have the responsibility of maintaining communication between the AQHYA Officers and AQHYA Directors, in addition to other duties as may be prescribed by the president.

Section 7. Second Vice President: In the absence of both the president and the first vice president, the second vice president shall have the powers and perform the duties of the president. The second vice president shall also have the responsibility of maintaining communication between the AQHYA Officers and AQHYA Directors, in addition to other duties as may be prescribed by the president.

Section 8. Two Members: The two members shall also have the responsibility of maintaining communication between the AQHYA Officers and AQHYA Directors, in addition to other duties as may be prescribed by the president.

Section 9. Immediate Past President: The immediate past president is not an electable office and can only be occupied for a one-year term by the previous year's AQHYA President. The immediate past president is not an AQHYA Officer, but shall have the responsibility of serving a one-year term on the AQHA Youth Activities Committee and assisting as a mentoring liaison between the AQHYA Officers and the AQHA Youth Activities Committee. If the position of immediate past president is vacated for any reason, the position shall remain vacant until the next year's officers are elected.

Section 10. Meetings of the AQHYA Officers: The AQHYA Officers shall meet whenever and wherever called by direction of the Advisory Board, of which meeting the Advisory Board shall give ten (10) days prior written notice, but such notice may be waived by any member.

Section 11. Quorum of AQHYA Officers: The quorum of the AQHYA Officers shall be three members.

Section 12. Vacancies of Directors or Officers: All vacancies with respect to Directors and AQHYA Officers shall be filled by the AQHYA Officers from the Board of Delegates for the unexpired term, and those so appointed shall serve until the election and acceptance of their duly qualified successors.

ARTICLE VIII: Removal of AQHYA Delegates, Directors or Officers

It is a privilege, not a right to serve as an AQHYA Delegate, Director or Officer. Throughout his/her tenure, such individuals must (1) remain an AQHYA member in good standing; (2) adhere to AQHYA and AQHA rules and regulations pertaining to membership conduct; (3) conduct themselves in an exemplary manner such as to favorably reflect on AQHYA; and (4) refrain from conduct that is detrimental to the interest of AQHYA, its programs, policies, objectives and harmonious relationship of its members. Such individuals' conduct is subject to continual review, and their service as an AQHYA Delegate, Director or Officer may be terminated or rejected by the Advisory Board with or without notice and formal hearing.

GENERAL RULES & REGULATIONS

GEN100. STANDING COMMITTEES at present include:

- Equine Research
- International
- Judges
- Marketing and Membership
- Nominations and Credentials
- Public Policy
- Racing
- Recreational Activities
- Shows
- Stud Book and Registration
- Youth Activities

GEN101. Standing Committee Members. Each standing committee shall consist of at least three members, appointed by the President with the advice and majority vote of the Executive Committee. To be eligible for a standing committee assignment, an individual must be a current AQHA member in good standing and complete the requisite application to be received by the office of the Executive Vice President on or before March 15 of the year that the individual is applying for standing committee assignment.

GEN101.1 To provide continuity and experience of members, standing committee assignments may be made for a term longer than one year, but in no event shall an appointment be longer than three years.

GEN101.2 To enable a standing committee to properly function, each member is required to attend all meetings; upon two consecutive absences, a member is automatically removed without further action.

GEN101.3 By unanimous vote, at any time during a standing committee member's tenure, with or without cause, the Executive Committee may terminate an individual's tenure on a standing committee. At its discretion, the Executive Committee may reassign the person to another standing committee. As service on AQHA's standing committees is a privilege, not a right, termination of tenure may be made without prior notice or right to hearing.

GEN101.4 Should a Director fail to be re-elected, or, for any reason fail to serve his term as an AQHA Director, his standing committee assignment is automatically terminated.

GEN102 Chair. Each standing committee shall be headed by a Chair who shall be elected annually by the respective standing committee members.

GEN102.1 The Chair shall vote only in case of a tie vote concerning committee action.

GEN102.2 An individual is eligible for annual election to the chairmanship of a committee, standing or otherwise, to a maximum of three consecutive terms, after which he is ineligible for re-election to the office until the expiration of one annual term, during which time another individual shall have served as chair.

GEN102.3 No AQHA Past President or former employee of AQHA may serve as Chair of a committee with the exception of the Hall of Fame Selection Committee, for which a Past President is eligible to serve as Chair.

GEN102.4 An interim Chair appointed by the Executive Committee shall serve as presiding officer in the Chair's absence or incapacity.

GENI03. Amendments. AQHA's rules and regulations, excluding those rules and regulations pertaining to registration of horses, may be amended at any time by change, addition or repeal by majority vote of the Executive Committee, but only after proposal of specific amendment shall have been approved by the appropriate standing committee or by the majority vote of the Executive Committee without such standing committee approval.

GENI03.1 Requirement of Prior Notice. To be eligible for consideration by a standing committee for possible recommendation to the Executive Committee, a proposed amendment shall be filed with AQHA's Executive Vice President on or before December 31 of the preceding year prior to AQHA's Annual Membership Meeting at which that standing committee's report concerning such proposed amendment is presented. Such required filing may be waived by the Executive Committee, after considering the merits of the proposed amendment.

GENI03.2 Period of Non-Amendment. A rule or regulation is not subject to amendment by change, addition or repeal until it has been in force for at least two calendar years. That limitation may be waived by the Executive Committee upon finding of extraordinary circumstances that (1) concerns the safety, health or well-being of a horse and/or rider, (2) materially benefits AQHA's programs or its financial stability or (3) involves other compelling circumstances.

GENI04. GENERAL PROVISIONS: MEMBERSHIP in AQHA is a privilege, not a right, application for which shall be made by procedures prescribed by AQHA. Membership, or application therefore, may be terminated or rejected by the Executive Committee or Board of Directors for cause detrimental to the interest of AQHA, its programs, policies, objectives and harmonious relationship of its members as determined by the Executive Committee or Board of Directors. Unless otherwise specified in AQHA rules, termination of a current membership under this rule shall be conducted under AQHA's disciplinary procedures for notice, hearing and temporary suspension. Rejection of an application shall not be grounds for or entitle an applicant to hearing. The effect of termination or rejection may be denial of the privileges of AQHA as set forth in AQHA's disciplinary procedure.

GENI04.1 An annual membership is not transferable.

GENI04.2 A complimentary renewal notice will be sent to members at their current address according to AQHA records at least thirty (30) days prior to the expiration date of the membership. With or without actual receipt of renewal notice, a member has sole responsibility over his membership status. An annual membership becomes delinquent on the last day of the month following expiration of term of membership eligibility and may be reinstated by payment of the current renewal fee, received by AQHA by the last day of the month following expiration, if the applicant otherwise qualifies for membership; otherwise, the applicant will be charged AQHA's current member fee.

GENI05. The name under which a membership may be obtained is limited to 30 characters including letters, spaces and marks of punctuation.

GENI06. Registrations must be recorded in the same name as appears on the membership card. If registrations are to be obtained, apply for membership in exactly the same name that registrations are to be recorded, i.e. the name of the individual, the name of a partnership, the corpo-

rate name (accompanied by the signature of the authorized agent as it is to appear on applications for registration).

GENIO6.I The record owner or record lessee of the dam of a foal for which a registration application is submitted must have a current membership at the time the registration application is submitted, or a non-member registration fee will be assessed.

GENIO7. The name of a female member may be changed to reflect her current marital status upon her request.

GENIO8. While in good standing, all members have equal rights, interests and responsibilities with respect to AQHA and its property; shall obey and be bound by all bylaws, rules and regulations of AQHA and decisions or actions of the Board of Directors or Executive Committee; have the right to vote by personal attendance at membership meetings; and have the right to hold office and committee assignments, except as otherwise limited. "Membership in good standing" means an individual or other legal entity who has paid the requisite membership fee; is not under current suspension by the Executive Committee or the Executive Vice President; or does not owe a delinquent financial obligation to AQHA for fees or other account payable for which written notice of suspension of membership or participation privileges has been sent.

GENIO9. Individuals who are non-members, but own American Quarter Horses, file registration applications and other documents with AQHA or participate in AQHA-approved events, by such actions and in regard to such transactions, agree to be bound by all bylaws, rules and regulations of AQHA and decisions and actions of the Board of Directors or Executive Committee. AQHA reserves the right to reject documents submitted by non-members who have engaged in acts detrimental to the humane treatment of horses or have engaged in acts detrimental to the intent of AQHA, its programs, policies, objectives or the harmonious relationship of its members.

GENIO10. Every member by joining AQHA, or non-member by purchasing American Quarter Horses, filing registration applications or other documents with AQHA or participating in AQHA-approved events, does thereby agree:

GENIO10.1 If unsuccessful in an attempt to overturn AQHA decisions, actions, rules or regulations, to reimburse AQHA for its reasonable attorney's fees, court costs and other expenses in defense of such suit, and

GENIO10.2 He/she will not commence any action, whether in law or equity, against AQHA in any courts other than those Federal and State courts located in Potter County, Texas.

GENIO11. As reciprocal assistance to AQHA for privilege of membership, participation in approved events and ownership of an American Quarter Horse, AQHA and the American Quarter Horse Foundation may use any photograph or other form of likeness reproductions of a member, event participant, horse owner, or their horses and registered equine names, to promote AQHA's objectives and activities including, but not limited to, use by third parties with authorization from AQHA. Members also agree that AQHA/AQHF may provide mailing list information to third parties (e.g., AQHA, affiliates and corporate partners) with authorization from AQHA/AQHF.

GENIO13. An AQHA member, including a member using AQHA data for commercial purposes, has a duty to preserve and protect the pedigree registry/performance records and the property of AQHA, including, but not limited to, AQHA electronic data made available to members

via the AQHA website or other pre-arranged consensual access thereto, and the duty to use such data only for the purposes for which AQHA has granted conditional license. Publication of such data shall carry the following designation: "This information was provided by the American Quarter Horse Association from its Official Records."

GEN114. AQHA MEMBERSHIP. Upon application, qualification and payment of the requisite fee, the recipient, during the designated period of eligibility, shall be entitled to the indicated membership privileges and, if 18 years or older, one vote on membership matters and eligibility to hold an office or director position with AQHA subject to AQHA bylaws.

GEN114.1 Full Membership Privileges, Individual:

Restricted to one person, carried in that person's legal name only, providing full privileges of AQHA including privilege to participate in AQHA's open division of shows and other AQHA activities that require individual membership.

GEN114.2 Membership Privileges, except privilege of participation in AQHA's open show division and other AQHA activities that require individual membership:

GEN114.2.1 Joint: A combination, to a maximum of two persons, such as husband and wife, and includes such designation as John and Jane Doe, John or Jane Doe, John and/or Jane Doe, and John/Jane Doe.

GEN114.2.2 Assumed or Trade Name: A person or persons, or artificial legal entity, such as A. Smith, d/b/a Smith Ranches; Smith Ranches, a sole proprietorship of A. Smith; Smith Ranches; or any other designation not being the legal name of the person or artificial legal entity.

GEN114.2.3 Corporate: Corporations in good standing in the state or country of their incorporation, the officers, representatives, shareholders and all beneficial owners.

GEN114.2.4 Partnership, General or Limited: Partnerships, general or limited, in good standing in the state, province or country of their organization, the partners, limited partners, representatives and all beneficial owners.

GEN114.2.5 Syndicate or Joint Venture: Syndicates or joint ventures, in good standing in the state, province or country of their organization, the representatives and all beneficial owners.

GEN114.2.6 Decedent's Estate, Trust, Guardianship or Other Custodial Legal Entity: Decedent's estate, trust, guardianship or other custodial legal entity, the person for which the entity is created, his representative, and all beneficial owners or beneficiaries.

GEN115. American Quarter Horse Youth Association Membership allows boys and girls 18 years of age or under, the privileges of membership in AQHYA, and, in addition, all of the privileges of an individual AQHA membership including privilege to participate in AQHA's open division and other AQHA activities that require individual membership, but not the privilege to vote at AQHA membership meetings or hold office or director position with AQHA.

GEN115.1 For youths whose 19th birthday is prior to January 1, the membership card will expire on December 31. The age of the youth as of January 1 will be the age maintained the entire year (regardless of the time of day the youth is born). For example, a youth who has a birthday in July and is 18 years of age January 1 *must show*

the entire year as a youth.

GENII6. Amateur AQHA Membership is for individuals otherwise qualifying for such membership under the rules of AQHA's amateur division, which allows the individual to participate in AQHA's amateur division, and, in addition, all of the privileges of an individual AQHA membership, including privilege to participate in AQHA's open division and other AQHA activities that require individual membership. National institutions of learning, executors, administrators, trustees or jointly held entities are excluded from amateur membership.

GENII6.1 The amateur applicant may convert a current AQHA 12-month individual membership for a fee of \$10, upon verification of amateur status. The expiration date for this membership will coincide with the membership being converted. Individual 12-month amateur membership is available for \$10 to a life member in the same individual identification number as the desired amateur membership designation.

GENII6.2 The amateur applicant may convert a current AQHA 36-month individual membership for a fee of \$20, upon verification of amateur status. The expiration date for this membership will coincide with the membership being converted. Individual 36-month amateur membership is available for \$20 to a life member in the same individual identification number as the desired amateur membership designation.

GENII6.3 Amateur membership cards will be issued by AQHA only upon application and AQHA approval of the applicant, which application shall be truthful in each and every detail. Submitting an application containing untrue statements shall subject the applicant to possible disciplinary action or suspension from participation privileges in AQHA-approved events or AQHA membership and/or fine. By submitting an application, applicant agrees to abide by AQHA amateur rules contained in this Rulebook including amateur rules set forth in SHW220-SHW229.

GENII6.4 The eligibility of all amateur membership card holders will be reviewed at the time application for renewal is submitted. Said application to be on a form supplied by AQHA and returned along with the appropriate fee. The renewal application shall affirmatively state that all previous representations contained in the individual's amateur application are still true and correct, verifying the individual's eligibility under AQHA amateur criteria. A false statement on a renewal application shall be grounds for disciplinary action under AQHA disciplinary procedure.

GENII6.5 Upon request by AQHA, an individual, who, for any reason, becomes ineligible for amateur membership, shall promptly return the amateur membership card to AQHA, whether or not AQHA request is made for it.

GENII6.6 Remaining months of membership for an amateur membership that is revoked may, at AQHA's discretion, be transferred to regular AQHA membership and a membership card issued to expire the same date as the original amateur membership card.

GENII6.7 A special handling service for an amateur membership card is available for \$10 for each card and is in addition to the regular fee and does not include overnight delivery.

GENII7. LIFE MEMBERSHIP is available, upon application and payment of appropriate fees, as follows:

Individual

Joint

Assumed or Trade Name

Corporate

Partnership, General or Limited

Syndicate or Joint Venture

Decedent's Estate, Trust, Guardianship or Other Custodial Legal Entity

American Quarter Horse Youth Association membership (through 18 years of age)

GENII7.1 Life membership shall have the same privileges as such designation carries with an annual membership, with the exception of AQHYA that carries special qualification requirements. Each officer, representative, director, shareholder, partner, beneficiary and each beneficial owner of a legal entity described above, and as to the estates, trusts, guardianships or other custodial legal entity, the person for which the entity is created must be eligible for individual membership in AQHA.

GENII7.2 AQHA life members who are youth (eligible through 18 years of age) shall have the same privileges as such designation carries with an AQHYA membership.

GENII7.3 An individual life membership may be amended one time at no charge. A joint life membership may be amended one time at no charge (1) at the written request of all joint owners or (2) at the written request of a joint owner whose request is based on (a) the death of a joint owner or (b) a final divorce decree or final judicial order establishing the rightful owner(s) of the life membership. A life membership held in the name of an entity described in GENII7 above may be amended one time at half the current life membership fee. Such request must be made by the owners/partners of the entity as evidenced by AQHA records. If a life membership is amended, the old life membership shall become inactive and shall be subject to nonmember fees should any future AQHA business be conducted under such membership. Further, any horses recorded in the old life membership shall remain in the name of the old life membership unless and until they are separately transferred pursuant to AQHA registration rules.

GENII8. VOTING PRIVILEGES: A person has one vote at AQHA membership meetings, annual or special, regardless of the number of individual or joint memberships he/she holds. For a person to vote the membership of a bona fide legal entity, he/she may not qualify to vote an individual, joint, assumed or trade name membership, and, in addition, upon request, shall provide AQHA with written authorization and substantiate the existence of the entity.

GENII9. HONORARY AQHA MEMBERSHIP: The Executive Committee may, from time to time, award an Honorary Membership to parties who merit special recognition for their individual efforts at the national or international level, in furtherance of the aims and objectives of AQHA. This membership shall have voting privileges. The honorary membership shall entitle the recipient to privileges regarding an annual membership, with the exception of AQHYA and amateur AQHA memberships, which carry special qualification requirements. Such membership may be designated by an appropriate plaque or certificate.

GENI20. RECORDS. Material accuracy of records furnished by AQHA either as hard copy or online service, is warranted by AQHA only to

the extent of using its best efforts in the compilation thereof, and then solely for the benefit of the member or party purchasing the record who may, as exclusive remedy, receive reimbursement for expense of the record upon showing material inaccuracy thereof. Consequential damages are expressly excluded. No warranties, express or implied, arise from records issuance, other than as stated herein, as the purchaser receives this record on an "as is" basis.

GENI21. STATE/PROVINCIAL AFFILIATES. AQHA may designate one affiliate association in each state/province, and when the state/province has an existing separate racing association, AQHA may designate it to represent the state/province's racing interests, as an affiliate association(s) to receive for its members and any local or regional association affiliated with the state/provincial association, such benefits and assistance as AQHA may, from time to time, determine, in return for the performance of duties and responsibilities to AQHA as specified in the affiliation agreement of the parties.

GENI21.I This affiliation is a privilege, not a vested right, granted or rejected at AQHA's discretion on an annual basis according to procedures and requirements formulated by the Affiliate Advisory Board, with the advice and consent of the Executive Committee. The affiliate association shall, in no manner, have authority, express or implied, to act for, or bind, AQHA in any manner.

GENI22. INTERNATIONAL ASSOCIATIONS. AQHA may recognize international associations that promote the American Quarter Horse. Such recognition is a privilege, not a vested right, granted or rejected at AQHA's discretion on an annual basis according to procedures and requirements formulated by AQHA and approved by the Executive Committee. If granted recognition by AQHA, an international association must annually agree to and sign an AQHA Agreement of International Affiliation and maintain required membership and registration numbers. Such recognition shall allow that international association the privilege of having an appointed Director on AQHA's Board of Directors as provided by AQHA bylaws. Members of recognized international associations shall remain governed by AQHA bylaws, rules and regulations.

GENI22.I The following international associations are recognized:

- American Quarter Horse Association of New Zealand
- American Quarter Horse Association of the United Kingdom
- Argentina Quarter Horse Association
- Australian Quarter Horse Association
- Austrian Quarter Horse Association
- Belgium Quarter Horse Association
- Brazilian Quarter Horse Association
- China Quarter Horse Association
- Colombian Quarter Horse Association
- Costa Rica Quarter Horse Association
- Czech Republic Quarter Horse Association
- Danish Quarter Horse Association
- Dominican Republic Quarter Horse Association
- Finnish Quarter Horse Association
- French Quarter Horse Association
- German Quarter Horse Association
- Hungarian Quarter Horse Association
- Irish Quarter Horse Association
- Israel Quarter Horse Association
- Italian Quarter Horse Association

Japan Quarter Horse Association
Quarter Horse Association of Luxembourg
Mexican Quarter Horse Association
Netherlands Quarter Horse Association
Norwegian Quarter Horse Association
Panama Quarter Horse Association
Paraguay Quarter Horse Association
Polish Quarter Horse Association
Slovak Quarter Horse Association
Slovenian Quarter Horse Association
South African Quarter Horse Association
Swedish Quarter Horse Association
Swiss Quarter Horse Association
Uruguay Quarter Horse Association
Venezuela Quarter Horse Association

GENI22.2 AQHA may accept a recognized international association's suspension of a member as grounds to automatically suspend such member's AQHA membership. AQHA's suspension of an individual's AQHA membership in such cases is subject to the recognized international association (a) reporting the suspension to AQHA and (b) verifying that the recognized international association provided the accused (i) prior notice of a hearing and (ii) the opportunity to present evidence on his behalf and to refute evidence offered against him.

GENI22.3 In regard to violations of AQHA rules prohibiting surgical alteration, administration of prohibited substance, and other prohibited practices, AQHA may give reciprocal effect to the disciplinary action of the Executive Committee or other governing committee of a recognized international association for terms up to a maximum of one year suspension from participation privileges at events approved or recognized by the international association, the effect of which shall be to bar the disciplined individual from participation in AQHA-approved events for a similar term.

GENI23. GENERAL NOTICE PROCEDURE.

GENI23.1 Rule, Regulation and Policy Changes.

GENI23.1.1 Official Handbook. Each member or American Quarter Horse owner is charged with notice of all rules and regulations published in the current Official Handbook. Upon request, AQHA furnishes each member a current Official Handbook. (online at aqha.com)

GENI23.1.2 The American Quarter Horse Journal. Additional to notice provided by this Official Handbook, a member or an American Quarter Horse owner has the affirmative duty to remain current with AQHA rules, regulations, policies and other matters pertaining to AQHA events and programs, that may be amended from time to time during a particular year, sometimes with immediate effect, rather than January 1 of a particular year when Official Handbooks are issued. To fulfill such duty, a member or horse owner should subscribe to *The American Quarter Horse Journal*, where notice of changes pertaining to such matters is routinely published or visit aqha.com. Although subscription to *The American Quarter Horse Journal* is not required, AQHA has fulfilled its duty to provide members and American Quarter Horse owners notice of these intra-year changes and proposed changes effective January 1 of the following year, by publishing them in *The American Quarter Horse Journal* or at aqha.com.

GENI23.2 Personal Service of Notice. Every notice required by these rules and regulations may be served by delivering the notice to the person to be served, or his attorney, by hand delivery, by U.S. mail postage prepaid, or by express mail to his last known address as it appears on AQHA's records. Notices delivered pursuant to this rule shall be deemed given: (1) at the time delivered, if personally delivered; (2) at the time received, if mailed; and (3) one business day after timely tender to the person, if delivered via express mail. Such notice may be served by facsimile (fax) transmission to the last known fax number or by email to the last known email address. Such transmission shall be deemed received by such person by confirmation of the transmission to AQHA.

GENI24. AVAILABILITY OF FAX OR EMAIL DELIVERY OF DOCUMENTS. AQHA employees are authorized, but not required, to accept a facsimile (fax) transmission or email of an original document, when, in the opinion of AQHA, the sender is (1) the authorized party executing the document or (2) a party having substantial interest in the subject horse who has obtained the original document from the authorized person and so verifies the genuineness of the document in the sender's possession to the satisfaction of AQHA. As a precaution, the fax or emails should be followed by the mailing of the original document, but this requirement is not a condition of accepting the fax or email.

CAN YOU AFFORD NOT TO KNOW?

THE ROBIN GLENN PEDIGREES' ONLINE DATABASE offers the industry's most current information on money earners in all types of performance events. With over **\$1 BILLION** dollars in horse earnings recorded in a database available 24/7, **RGP** offers detailed show results, "best cross" reports, customizable sire and dam reports, free foal tracking and more.

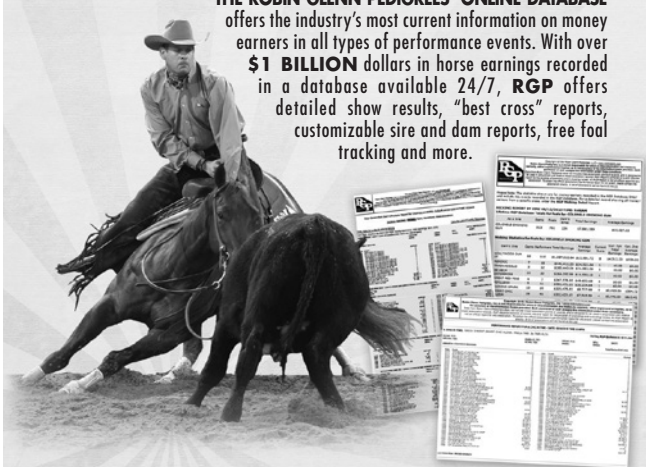

**INFORMATION WHEN YOU NEED IT,
WHERE YOU NEED IT - ALL IN ONE PLACE.**



Visit www.robinglenn.com today!

FEES

FEE100. General Provisions

FEE100.1 Payment is required at the time of processing and payable in U.S. funds only. Mailing address: P.O. Box 200, Amarillo, Texas 79168. **Overnight delivery:** 1600 Quarter Horse Drive, Amarillo, Texas 79104. www.aqha.com. 806-376-4811

FEE100.2 Eligibility for renewing a membership at the reduced rate requires payment to be renewed within 30 days of expiration.

FEE100.3 Through the payment of a membership fee to AQHA, an individual acknowledges that membership in AQHA is voluntary and agrees to be bound by all terms and conditions provided in this Rulebook.

FEE100.4 AQHA upgrades are available to AQHYA members whose youth eligibility has expired. The upgrade request must be made prior to June 30 in the year after the youth member turns 19.

FEE100.5 Registration fees are determined by the actual age of the horse according to the date the application is received in AQHA's office, as evidenced by AQHA's date stamp. **EXAMPLE:** Foaling date of February 15, the 7 month deadline is September 15.

FEE100.6 A rush/special handling service is available for specified transactions and provides for expedited processing within 2-4 working days. To receive the special handling service, this fee must be submitted in addition to the applicable fee and the envelope should be clearly marked *Special Handling Service Requested*. The rush fee does NOT include overnight return service.

FEE100.7 For complex transactions AQHA may charge for excess time expended by employees at a minimum fee of \$100.00 per hour. AQHA will notify you if your case falls into this category prior to completing any work.

	Member	Nonmember
FEE101. ADVANCEMENT FROM APPENDIX REGISTRY		
Gelding	\$25	\$65
Mare	\$50	\$90
Stallion	\$100	\$140

FEE102. ASSOCIATION OF PROFESSIONAL HORSEMEN

Annual	\$50	NA
36-month	\$120	NA

FEE103. BREEDER REFERRAL

Annual	\$25	NA
36 months	\$60	NA

FEE104. CERTIFICATE - DUPLICATE, CORRECTED OR REPLACEMENT

Corrected certificate	\$15	\$15
Duplicate certificate	\$30	\$70
Replacement certificate	\$10	\$50
Name change (<i>horse; if permitted</i>)	\$55	\$95
Reservation of horse name	\$75	\$115
Re-registration	\$50	\$90
Optional, additional charge(s):		
Rush/special handling <i>per certificate</i>	\$30	\$30

FEE105. EMBRYO TRANSFER ENROLLMENT

Annual	\$100	\$140
Lifetime	\$500	\$540

FEE106. FROZEN EMBRYO PERMIT \$50 \$90

FEE107. FROZEN SEMEN PERMIT \$50 \$90

	Member	Nonmember
FEEI08. GENETIC TESTING		
DNA kit <i>for unregistered foal</i>	\$40	\$40
DNA kit <i>for registered horse</i>	\$50	\$50
Postmortem Testing	\$300	\$300
HYPP kit (<i>separate from panel test</i>)	\$40	\$40
Disease Panel Test (HYPP, GBED, HERDA, PSSMI, MH)	\$85	\$125
Disease Panel and DNA	\$105	\$145
Optional, additional charge(s):		
Rush/special handling	\$10	\$10
FEEI09. HORSEBACK RIDING PROGRAM		
Enrollment	\$35	\$75
FEEI10. LEASE		
Breeding lease	\$20	\$60
Showing lease <i>for amateur</i>	\$30	\$80
Showing lease <i>for youth</i>	\$30	\$45
Show lease <i>for open</i>	\$30	\$70
Replacement lease certificate	\$10	\$50
FEEI11. MEMBERSHIP		
AQHA life	\$750	N/A
AQHA 12 month	\$35	\$40
AQHA 36 month	\$85	\$85
12 month <i>upgrade to Amateur</i>	\$10	N/A
36 month <i>upgrade to Amateur</i>	\$20	N/A
Amateur 12 month	\$45	\$50
Amateur 36 month	\$105	\$105
AQHYA 12 month	\$15	\$15
AQHYA 36 month	\$35	\$35
AQHYA life	\$50	N/A
AQHYA life <i>upgrade to AQHA life</i>	\$700	N/A
Graduating Youth <i>upgrade to</i> <i>4-year AQHA membership</i>	\$85	N/A
Graduating Youth <i>upgrade to</i> <i>4-year Amateur membership</i>	\$105	N/A
FEEI12. REGISTRATION		
Foaling date to 7 month birthdate	\$35	\$75
8 to 12 month birthdate	\$65	\$105
13 to 24 month birthdate	\$155	\$195
25 to 36 month birthdate	\$305	\$345
37 to 48 month birthdate	\$405	\$445
Past 48 month birthdate	\$505	\$545
Optional, additional charge(s):		
Rush/special handling	\$40	\$40
FEEI13. STALLION BREEDING REPORT		
Filing fee per stallion	\$25	\$65
Plus per mare exposed	\$5	\$10
Late filing fee, <i>in addition to regular fee</i>	\$30	\$30
Photocopy of stallion breeding report	\$5	\$10
FEEI14. TATTOOING		
	\$100	\$100
FEEI15. THOROUGHBRED RECORDS		
Thoroughbred recording fee	\$50	\$90
Thoroughbred ownership update	\$20	\$60
FEEI16. TRANSFER		
	\$20	\$60
Optional, additional charge(s):		
Rush/special handling <i>per transfer</i>	\$25	\$25

VIOLATIONS

VIO100. No person shall refuse to assist AQHA, its officers, committees or agents 1) in locating, identifying and inspecting, or to answer promptly and truthfully any inquiry concerning a horse or an ancestor thereof, that has been registered with AQHA, or for which application to register has been made; or 2) to promptly and truthfully give information, in form requested, concerning any AQHA matter of which the person has or may have knowledge.

VIO101. In the furtherance of their official duties, all AQHA representatives shall be treated with courtesy, cooperation and respect, and no person shall direct abusive or threatening conduct or language toward them.

VIO102. No person or entity shall bribe, or attempt to bribe, an AQHA representative, AQHA-approved judge or any other official of an AQHA-approved event.

VIO103. Any member may be suspended and denied AQHA privileges and any non-member may be denied AQHA privileges by AQHA's Executive Vice President for failure to timely file with AQHA any report or document (including registration related documents) required by the rules of AQHA or submit a response to an AQHA inquiry; provided, however, that fifteen (15) days before action by the Executive Vice President, written notice of the delinquent report/response and the intention to suspend and/or deny AQHA privileges shall be mailed to such member or non-member. Upon suspension and/or denial of AQHA privileges by the Executive Vice President, the name, address, city and state of such member or non-member and description of disciplinary action may be published in *The American Quarter Horse Journal* or on AQHA's official web site, *aqha.com*. Any suspension and/or denial of AQHA privileges under this rule shall terminate upon the filing of the requisite report/response.

VIO104. A member or nonmember shall not conspire with another person or persons to intentionally violate AQHA rules, or to knowingly contribute or cooperate with another person or persons, either by affirmative action or inaction, to violate AQHA rules.

VIO105. All information furnished AQHA as a basis for any action by AQHA or any of its officers shall be true and correct.

VIO106. Ownership of an issued registration certificate remains with AQHA; it is issued in reliance on a written application submitted and attested by the owner at time of foaling and upon the express condition that AQHA has the privilege to correct and/or cancel the certificate for cause under its rules and regulations.

VIO107. No change or alteration of a registration certificate shall be made except by AQHA or its official representative upon proper showing of the necessity for such change or alteration, by reason of change in color or markings, or mistake; nor shall any person display or advertise, or have in his possession, a certificate that has been changed or altered otherwise than by AQHA or on its authority.

VIO108. No person or entity shall:

VIO108.1 refuse an AQHA request for the return of a registration certificate, either before, after or pending hearing to determine registration or participation privilege in AQHA-approved events. AQHA may retain possession of a certificate until resolution of the matter for which the return of the certificate was requested;

VIO108.2 issue, sell, exchange, give away or receive, or offer a false or fraudulent certificate, representing the same to be a genu-

ine official certificate issued by AQHA;

VIO108.3 represent any horse owned or managed by him to be AQHA registered unless the same be registered in the official Stud Book;

VIO108.4 represent as a registered American Quarter Horse any horse other than the horse for which the registration certificate was issued;

VIO108.5 advertise or enter in any American Quarter Horse event or competition any AQHA registered horse by a name other than that by which the horse is registered;

VIO108.6 represent, by advertisement, claim or otherwise, that a horse registered with AQHA has earned or is entitled to any official AQHA designation or honors prior to actual recording of such designation or honor in the records of AQHA;

VIO108.7 alter, in any way change, or attempt to hide or alter natural markings of a horse by surgery, dye or in any other manner.

VIO200. INHUMANE TREATMENT. No person shall treat any horse in an inhumane manner. This prohibition against inhumane treatment applies to AQHA members and nonmembers. Inhumane treatment shall include, but not be limited to, the prohibited conduct specified below. Inhumane treatment to horses other than American Quarter Horses and other animals used in competition is included in this prohibition as it indicates a general course of dealing with horses which is unacceptable to AQHA.

VIO200.1 For purposes of this rule, a person responsible for the care of a horse is also responsible for and may be disciplined for the inhumane conduct of their trainers, agents, representatives and employees. For violation of this rule, an individual may be disciplined, suspended, fined, denied AQHA privileges, disqualified, expelled from show grounds and/or expelled from AQHA.

VIO201. Inhumane treatment of any horse or any other animal on show grounds is strictly prohibited. Treatment of any horse will be considered inhumane if a person, educated or experienced in accepted equine training techniques, would perceive the conduct of an individual to be inhumane.

VIO202. For purposes of this rule, a fines and penalty system has been established based on the severity of the offense. All offenses per VIO204 below will be assigned a minimum level of offense (level 1 = mild; level 2 = moderate; level 3 = severe). Depending on the facts of a situation, the level of offense may be increased.

VIO203. Warning or Show Ground Removal cards will be issued based on the frequency and level of offense.

VIO204. Inhumane treatment includes, but is not limited to:

VIO204.1 placing an object in a horse's mouth so as to cause undue discomfort or distress (minimum level 2);

VIO204.2 leaving a bit in a horse's mouth for extended periods of time so as to cause undue discomfort or distress (minimum level 1);

VIO204.3 tying a horse's head up (above withers), back or around in a stall or anywhere at an AQHA event in a manner as to cause undue discomfort or distress (minimum level 2);

VIO204.3.1 Tying a horse in a stall without access to food or water for an extended period of time. (minimum level 1)

VIO204.4 lounging or riding a horse in a manner as to cause undue discomfort or distress to the horse (minimum level 1);

VIO204.5 tying or fastening any foreign object onto a horse,

halter, bridle and/or saddle in order to de-sensitize the horse (minimum level 2);

VIO204.6 use of training techniques or methods such as poling or striking a horse's legs with objects (minimum level 2);

VIO204.7 excessive spurring or whipping (minimum level 1);

VIO204.8 excessive jerking of reins (minimum level 1);

VIO204.9 excessive fencing (minimum level 1);

VIO204.10 excessive spinning (defined as no more than eight (8) consecutive turns in either direction) (minimum level 1);

VIO204.11 schooling over ramped oxers in reverse order (i.e., from highest to lowest instead of lowest to highest) (minimum level 1);

VIO204.12 schooling using rails higher than four (4) feet (minimum level 1);

VIO204.13 use of prohibited equipment, including, but not limited to: saw tooth bits; hock hobbles; tack collars; tack curb staps or tack hackamores; whips used for showmanship; war bridles or like devices; wire or solid metal curb straps no matter how padded; wire cavesson; wire or cable tie-downs; bumper bits; metal bosals (no matter how padded); metal longeing hackamores; chambons; headstalls made of metal (no matter how wrapped or padded), twisted rawhide, or rope may not be used on a horse's head (3/8 inch rope may be used with a slip/gag bit or a bonnet); running martingales used with curb bits used without rein stops; (minimum level 2); riding in a curb bit without a curb strap; draw reins attached between or around the front legs will not be allowed; side reins (direct rein from bit to cinch or surcingle); excessively tight cavessons (minimum level 1) will not be allowed at AQHA-approved events;

VIO204.14 use of any item or appliance that restricts circulation of the horse's tail (minimum level 3); use of any item or appliance that restricts movement of the horse's tail is a minimum level 1 violation.

VIO204.15 a horse which appears to be sullen, dull, lethargic, emaciated, drawn or overly tired (minimum level 1);

VIO204.16 intentional or negligent treatment which results in any bleeding – intentional (minimum level 3); unintentional (minimum level 1); for purposes of this section, "negligence" is the failure to exercise care that a reasonably prudent person would exercise. Regardless of whether bleeding resulted from intentional or negligent treatment, horse may be disqualified.

VIO204.17 applying excessive pressure on or excessively jerking of a halter lead shank (minimum level 2).

VIO204.18 any other treatment or conduct deemed by a show official to be inhumane or abusive (minimum level 1).

VIO205. AQHA may accept (1) an individual's conviction, no contest plea, or deferred adjudication or (2) judicial confiscation of a horse under state, federal, provincial or international law, for an offense of cruelty to or inhumane treatment of a horse, whether or not an American Quarter Horse is involved, as a presumptive violation of this rule, the effect of which is to automatically suspend the individual from AQHA membership privileges, or deny such privileges, for a period of no less than two (2) years after AQHA receives notice of the conviction, no contest plea, deferred adjudication or judicial confiscation. After the expiration of the two-year suspension, the individual may apply for reinstatement. AQHA may also temporarily suspend an individual charged or indicted pursuant to state, federal, provincial or international law for an offense of cruelty or inhumane treatment of a

horse, whether or not an American Quarter Horse. Such temporary suspension may remain in place pending the outcome of the legal proceedings made basis of the charge or indictment.

VI0206. AQHA may accept suspension rulings pertaining to cruel or inhumane treatment of horses from other recognized equine related associations and state racing commissions, the effect of which is to automatically suspend the individual from AQHA membership privileges, or deny such privileges, for a length of time equal to the suspension for which reciprocity is given.

VI0220. UNSPORTSMANLIKE CONDUCT or any other form of misconduct that is irresponsible, illegal, indecent, profane, intimidating, threatening or abusive is prohibited. This provision applies to:

VI0220.1 AQHA members, nonmembers, exhibitors, trainers, owners, owner representatives, spectators and all other persons on the show grounds of an AQHA-approved event; and

VI0220.2 AQHA members on the show grounds of an event held in conjunction with an AQHA-approved event; and

VI0220.3 AQHA members on the show grounds of an event during which an AQHA-approved class is held regardless of whether the conduct is associated with or occurs during an AQHA-approved class.

VI0221. Show management may immediately expel individuals exhibiting unsportsmanlike conduct from show grounds and shall file a written report with AQHA concerning the conduct in question.

VI0230. INHIBITING COMPETITION. Any form of conduct that inhibits competition at AQHA-approved events is expressly prohibited. This offense includes not only the person suggesting the prohibited conduct, but all who participate in the scheme or plan. Such conduct includes, but is not limited to:

VI0230.1 padding classes by entering a horse(s) not otherwise qualified for the competition to fill a class to increase points;

VI0230.2 paying another's entry fee, directly or indirectly; or

VI0230.3 encouraging a potential competitor to refrain from entering the class.

VI0231. For inhibiting competition, an AQHA member may be disciplined, suspended, fined and/or expelled from AQHA, and a nonmember may be denied AQHA privileges. Furthermore, violation of this rule shall be grounds for AQHA to disqualify the horse(s) entered by the persons that participate in the scheme or plan prohibited by this rule.

VI0232. To assist AQHA in the promotion of true competition, any person approached by another to cooperate in a scheme or plan to inhibit competition shall immediately report the matter to show management and then to AQHA in writing within 10 days, failing which, the person approached may be subject to disciplinary action by the Executive Committee, the same as the person or persons suggesting the scheme or plan.

VI0233. AQHA Stewards may immediately issue a warning or removal cards (from show grounds) to individuals whose conduct is in violation of AQHA rules and shall file a written report with AQHA concerning the conduct in question. Individuals receiving two warning cards from AQHA Stewards in a 12-month period may be cited to appear before an AQHA hearing committee in accordance with AQHA's disciplinary procedures. Regardless of whether an AQHA Steward is present at the show in question or whether an AQHA Steward takes action regarding violations of AQHA rules, nothing herein

prevents show management or AQHA from taking appropriate action with respect to individuals who violate such rules.

VIO240. PROHIBITED ASSISTANCE. If a contestant, while inside the show arena or show ring, is assisted in any manner by another person or provides assistance in any manner to another person, the contestant shall automatically be disqualified. This rule does not apply to co-contestants assisting each other in team events such as dally team roping, cutting, team penning or ranch sorting. Furthermore, this rule does not apply to a contestant who assists another contestant if such assistance was necessitated for the safety of competing exhibitors or horses as determined by the judge--however, the contestant in need of such assistance shall be disqualified.

VIO250. RESPONSIBLE PARTY. The exhibitor, Absolutely Responsible Person and owner (collectively referred to as "Responsible Parties") are each responsible for a horse's condition, presumed to know all AQHA rules and regulations and are eligible for disciplinary sanctions for violation of AQHA rules and regulations according to AQHA's disciplinary procedures.

VIO251. An individual is an Absolutely Responsible Person if:

VIO251.1 he/she designates himself/herself on the entry blank as exhibitor, or authorizes another to designate him/her as exhibitor on the entry blank;

VIO251.2 he/she signs the entry blank on behalf of himself/herself or another, or causes an agent or representative to sign it;

VIO251.3 he/she physically participates in the event by riding or showing the horse; or

VIO251.4 he/she is the actual trainer, having presented or caused to be presented the horse at the show grounds for exhibition.

VIO252. Both the exhibitor designated on the entry blank and one having actual possession of the horse while physically participating with the horse in the event are conclusively presumed to be authorized by the owner to execute all documents, necessary or convenient, to allow the horse's participation in an AQHA-approved event, including documents pertaining to drug testing and the use of Lasix. If an individual is prevented from performing his/her duties, including absolute responsibility for the condition of the horse, by illness or otherwise, or is absent from the show, he/she shall immediately notify the show secretary, and appoint a substitute, and such substitute shall place his/her name on the entry blank. The exhibitor and owner acknowledge an exhibitor represents the owner in regard to his/her horses entered in an approved show.

VIO253. Upon request of show management or AQHA representative, every Responsible Party shall:

VIO253.1 permit examination of a horse for determination of the presence of prohibited surgery, mechanical device, artificial appliance, foreign drug or substance;

VIO253.2 permit examination of a horse for determination of normal tail function; and

VIO253.3 permit a specimen of urine, saliva, blood or other substance to be taken for testing.

VIO253.4 Refusal to comply with such request shall constitute grounds for immediate disqualification of the horse from further participation at the show, the horse being barred from participation in future AQHA-approved events or shows for such period as determined by the Executive Committee or other appropriate committee

and suspension of the Responsible Party's AQHA membership.

VIO300. PROHIBITED MEDICATION, DRUG, SUBSTANCE. No person shall cause to be administered internally or externally to a horse, either before or during an approved event, any medication, drug, or substance which could affect its performance or appearance at that event, except for those conditionally permitted therapeutic medications, the use of which is specifically provided for in the therapeutic medication addendum and not otherwise prohibited by governmental regulations.

VIO301. Upon discovery of administration of such prohibited medication, drug or substance, show management shall immediately report the matter to AQHA. Any substance, administered internally or externally, whether drugs or otherwise, or action which may interfere with the testing procedure or mask or screen the presence of a prohibited medication, drug or substance is forbidden.

VIO302. It is presumed the sample of urine, blood, saliva or other substance tested by the approved laboratory is the one taken from the horse in question, its integrity is preserved, and that all procedures of such collection and preservation, transfer to the laboratory, and analysis of the sample are correct and accurate, and the report received from the laboratory pertains to the sample taken from the horse in question and correctly reflects the condition of the horse during the show in which it was entered, with the burden on the exhibitor or other Responsible Party to prove otherwise at any hearing in regard to the matter conducted by AQHA.

VIO303. If the laboratory report on the chemical analysis of urine, blood, saliva or other sample taken from the horse indicates the presence of a forbidden medication, drug or substance, this shall be taken as prima facie evidence such forbidden medication, drug or substance has been administered to the horse either internally or externally.

VIO304. The Responsible Party is eligible for disciplinary sanctions, whether or not they had actual knowledge of the presence of a prohibited medication, drug or substance, directly participated in the administration thereof, innocently miscalculated its retention time in the horse's system, or any other reason for which its presence is established.

VIO305. Presence of a prohibited medication, drug or substance in a horse participating in an AQHA-approved event shall be grounds for the Executive Committee to take the following action if it is determined that the use of said medication, drug or substance was not within the guidelines set forth in the Therapeutic Medication Addendum:

VIO305.1 disqualify the horse from all classes in which it participates at the show;

VIO305.2 bar the horse from participation in further AQHA-approved events or shows for such period as determined appropriate, and, upon request, the owner shall deliver the horse's registration certificate to AQHA to either be held during the period of the horse's suspension from participation or for purposes of AQHA to prominently notate the horse's ineligibility to participate in AQHA-approved events on the face of the registration certificate. Although ownership of such horse may, thereafter, be transferred to another party, the transfer of ownership will not dissolve or shorten the terms of a suspension/ineligibility to participate; and

VIO305.3 discipline the Responsible Party(ies) under AQHA's general disciplinary procedure or offer an administrative penalty as

determined appropriate by the Executive Committee.

VIO305.4 Pending final hearing by the Executive Committee or such other appropriate hearing committee, the Executive Vice President may, by giving written notice of its action to the owner of record at his current address as shown on AQHA records, temporarily suspend such horse from further participation in an AQHA-approved event or show.

VIO320. PROHIBITED SURGICAL PROCEDURE, MECHANICAL DEVICE OR ARTIFICIAL APPLIANCE.

Any surgical procedure, mechanical device or artificial appliance that could affect a horse's performance or alter its natural conformation or appearance is prohibited unless it meets one of the following exceptions:

VIO320.1 surgical procedures performed by a duly licensed veterinarian for the sole purpose of protecting the health of the horse;

VIO320.2 use of a pacemaker or prosthetic eye if the owner files a written request for permission and requests it be reviewed and considered by AQHA's Executive Committee (approval, if granted, will be noted on the horse's registration certificate);

VIO320.3 tails lengthened by hair to hair attachment only with no attachments of any kind to the tailbone. The use of weighted tails is legal; or

VIO320.4 earplugs or cotton in the horse's ears.

VIO321. Upon discovery of the existence of prohibited surgery, mechanical device or artificial appliance, show management shall immediately report the matter to AQHA.

VIO322. The Responsible Party is eligible for disciplinary sanctions, whether or not they had actual knowledge of the surgical procedure, mechanical device or artificial appliance, or directly authorized the surgical procedure or administration of prohibited devices. Purchase, and subsequent exhibition of a horse with such condition in an AQHA-approved show makes an individual a Responsible Party under this rule. Violation of this rule is grounds for the Executive Committee, or an appropriate committee of AQHA, to take disciplinary action according to AQHA's disciplinary procedures.

VIO330. ALTERATION OF TAIL FUNCTION. For the purpose of this rule, normal tail function is defined as "being able to raise the tail to or above the horizontal plane." See diagram below. A horse's inability to raise its tail to or above the horizontal plane in response to a tail test conducted on-site by an AQHA-approved veterinarian shall be considered a violation of this rule. An AQHA-approved veterinarian may examine any registered American Quarter Horse for an altered tail if entered in any event held in conjunction with an AQHA-approved show, whether or not said event is approved by AQHA.

VIO330.1 The above prohibition includes application or administration of any drug, chemical, foreign substance, surgical procedure, or trauma, accidental or intentional (as to trauma, this prohi-

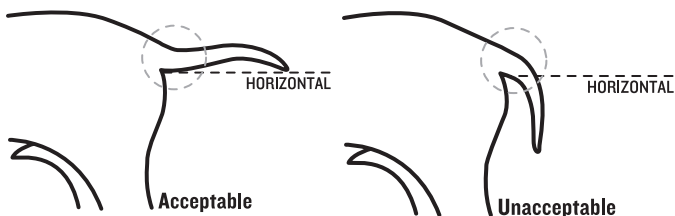

bition applies to horses foaled after January 1, 1990), which results in, or could result in, alteration of normal tail function, carriage, conformation or overall appearance of the horse.

VI0331. The Responsible Party is eligible for disciplinary sanctions, whether or not they had actual knowledge of the trauma, authorized the surgical procedure or directly participated in the administration of any drug, chemical or foreign substance that altered normal tail function. Purchase and subsequent exhibition of a horse with such condition in an approved show makes an individual a Responsible Party under this rule. Violation of this rule is grounds for the Executive Committee, or an appropriate committee of AQHA, to take disciplinary actions according to AQHA's disciplinary procedures.

VI0332. If, upon examination by AQHA or show representative (after obtaining prior AQHA authorization), a horse's tail function or appearance is found to be abnormal, the horse shall be immediately reported to AQHA. Upon written notification to the owner by AQHA, the horse's participation privileges in AQHA-approved events may be temporarily suspended pending hearing.

VI0333. A horse found to have abnormal tail function or appearance may have its participation privileges reinstated if, upon examination by AQHA's approved veterinarians, the tail is found to be normal in both appearance and function. Unless otherwise specified herein, a minimum of one year from the time of suspension of privileges must elapse before the horse is eligible for re-examination at the owner's expense. After such examination, participation privileges of the horse will remain suspended until reconsideration by the Executive Committee or any appropriate committee of AQHA, which the owner must request in writing. The owner shall have the burden of persuasion to prove normal tail function and appearance.

VI0334. In the case of trauma to a horse's tail which does alter or could result in alteration of tail function, to shorten the stipulated one-year period prior to consideration for reinstatement provided above, the owner shall file a written report concerning the injury and its circumstance with AQHA within 30 days of the occurrence.

VI0334.1 Upon receipt of this report, at the owner's expense, AQHA may require a veterinarian examination that becomes a part of the horse's file. The veterinarian must be approved by AQHA.

VI0334.2 Within one year from the filing date by the owner of the trauma report, if the Executive Committee has, in the meantime, barred the horse from participation in AQHA-approved events, or if an owner's report has been filed, after one year from the date of Executive Committee action barring the horse, the owner may request, in writing, a re-examination of the horse and rehearing before the Executive Committee for a determination as to whether the horse's tail function, carriage, conformation and overall appearance is normal. If the Executive Committee's determination is adverse, the owner may repeat his request for reinstatement at the expiration of one year from the date of the latest hearing. The owner shall have the burden of persuasion to prove normal tail function and appearance.

VI0400. THERAPEUTIC MEDICATION ADDENDUM

VI0400.1 Does not apply if prohibited by governmental regulations.

VI0400.2 Exhibitors, owners, trainers and veterinarians are cautioned against the use of medicinal preparations, tonics, pastes and products of any kind, the ingredients and quantitative analysis

of which are not specifically known, as many of them may contain a forbidden substance.

VIO400.3 A Therapeutic Medication Hotline is available by calling 1-800-633-2472.

VIO401. Forbidden drugs or substances include:

VIO401.1 Any drug or substance considered a Class I or Class II substance as defined in the most recent edition of American Racing Commissioners International Uniform Classification Guidelines for Foreign Substances.

VIO401.2 Any stimulant, depressant, tranquilizer or sedative which could affect the performance of a horse (stimulants and depressants are defined as substances that stimulate or depress the cardiovascular, respiratory or central nervous system).

VIO401.3 Any substance, regardless of how harmless or innocuous it might be, that might interfere with the detection or quantitation of any substance defined in VIO401.1 or VIO401.2.

VIO401.4 Any anabolic steroid in halter classes, VIO402 – VIO403 do not apply.

VIO401.5 Any nonsteroidal anti-inflammatory drug (NSAID) other than those listed in VIO405.1 – VIO405.8 below.

VIO401.6 Clenbuterol

VIO401.7 Any metabolite and/or analog of any of the above described forbidden drugs or substances.

VIO402. Conditionally Permitted Therapeutic Medication: Any drug, medication or substance that could affect the performance of a horse that is used for the legitimate treatment of illness or injury and is not specified as a forbidden substance as defined in VIO401.1, VIO401.5 or 401.6 above shall be considered a conditionally permitted therapeutic medication. However, conditionally permitted therapeutic medications are forbidden and use thereof subjects the person to disciplinary action, unless all conditions of their administration are met.

VIO403. Each of the following requirements is a condition to authorize administration of conditionally permitted therapeutic medications, which shall be verified in a written medication report, available from AQHA or show management, completed in its entirety, and filed with show management before exhibition of the horse per VIO403.3 – VIO403.10 below:

VIO403.1 Administration by a veterinarian who is licensed to practice veterinary medicine in the state, province or country where the event is being held (“Licensed Veterinarian”) or from a written prescription (written instructions) by a Licensed Veterinarian which documents administration of medication is necessary for the legitimate treatment of illness or injury. The administration of a conditionally permitted therapeutic medication for the purpose of transport, grooming, training, etc. is not therapeutic under this authorization rule.

VIO403.2 The horse must be withdrawn and kept out of competition for not less than 24 hours after the medication is administered.

VIO403.3 Identification of the medication: the name, amount, strength/concentration and mode of administration.

VIO403.4 Date and time of administration.

VIO403.5 Identification of the horse: name, age, sex, color and entry number.

VIO403.6 Diagnosis of illness/injury, reason for administration,

and name of administering and/or prescribing AAEP veterinarian.

VI0403.7 Signature of veterinarian or person administering the medication. If by prescription (written instructions), a copy must be attached to the medication report.

VI0403.8 The medication report must be filed with show management within one hour after administration of the medication or one hour after show management is available, if administration occurs at a time other than during competition hours.

VI0403.9 The medication report must be signed by show management and time of receipt recorded on the report.

VI0403.10 While the medication report must be filed only if the administered medication will be present in amounts detectable in blood and/or urine samples at the time of competition/sampling, exhibitors are hereby cautioned it is their responsibility to determine whether or not such medication has had time to clear the horse's system. If there is any doubt, a medication report should be filed.

VI0403.11 Regardless of whether the medication report requirements described above are met, laboratory detection of concentration levels of an otherwise conditionally permitted therapeutic drug that are inconsistent with the administration of a therapeutic dosage of such drug (including, but not limited to, inconsistencies regarding reported dosage and time constraints) shall constitute presumption of a violation of this rule, and the Responsible Party has the burden of persuasion to establish that the drug was administered in a therapeutic dosage and not less than 24 hours prior to competition.

VI0403.12 Regardless of whether all of the conditionally permitted therapeutic medication requirements listed in VI0403 are met, it shall be considered a rule violation if the same plasma or urine sample contains more than one (1) of the permitted NSAIDs listed in VI0405.1 - VI0405.8

VI0404. Restrictions concerning the use of conditionally permitted therapeutic medications that may be administered within 24 hours of showing:

VI0404.1 Subject to the specified restrictions, only those thirteen (13) drugs or medications listed in VI0405.1 – VI0405.12 below may be administered within 24 hours of showing. The provisions in VI0405.1 – VI0405.12 below contain rules concerning maximum allowable plasma concentration levels followed by "Guidelines".

The Guidelines are applicable to most horses. Nevertheless, reliance upon the guidelines does not guarantee compliance with the rules, since the response of individual horses may vary. Exhibitors, owners, and trainers should consult the drug manufacturer and knowledgeable veterinarians for up-to-date information and more specific advice concerning the therapeutic use of a drug or medication for a particular horse.

The Guidelines, if heeded, will minimize the chances of positive drug tests. However, all Responsible Parties are cautioned that the guidelines are only general guidelines, and it is their responsibility to see to it that conditions prevail for full compliance with all AQHA rules. Reliance upon the Guidelines will not serve as a defense to a charge of violation of the rule in the event of a positive drug test.

Should the testing laboratory report the presence of one of the drugs or medications listed in VI0405.1 – VI0405.12 below in an

amount greater than what would be consistent with the Guidelines or at a level higher than a specified maximum permitted plasma concentration, the matter will be reviewed and disciplinary action may be taken.

VO404.2 Regardless of whether all of the conditionally permitted therapeutic medication requirements for a specific NSAID listed in VIO405.1 – VIO405.8 below are met, it shall be considered a rule violation if the same plasma or urine sample contains more than one (1) of the NSAIDs listed in VIO405.1 - VIO405.8 below.

VIO405. CONDITIONALLY PERMITTED THERAPEUTIC MEDICATIONS. Only those 12 drugs or medications listed below may be administered within 24 hours of showing:

VIO405.1 Phenylbutazone (an NSAID) - The maximum permitted plasma concentration of phenylbutazone is 15.0 micrograms per milliliter.

Guidelines: When phenylbutazone is administered, the dose should be accurately calculated according to the actual weight of the animal. Each 24 hours, not more than 2.0 milligrams per pound of body weight should be administered, preferably less. For a 1,000 pound animal, the maximum daily dose is 2.0 grams, which equals two 1.0 gram tablets, or two 1.0 gram units of paste, or 10.0 cc of the injectable (200 milligrams per milliliter). Neither a total daily dose nor part of an injectable dose should be administered during the 12 hours prior to competing. In the event the phenylbutazone is administered orally, half of the maximum daily dose (1.0 gram per 1,000 lbs) can be administered each 12 hours (i.e., 12 hours apart) during a five day treatment program even if such oral administration occurs within 12 hours of competition. Phenylbutazone should not be used for more than five successive days.

VIO405.2 Diclofenac (Surpass) (an NSAID) - The maximum permitted plasma concentration of Diclofenac (Surpass) is 0.005 microgram per milliliter.

Guidelines: Every 12 hours, not more than 73 mg of diclofenac liposomal cream should be administered (not more than 146 mg per 24 hour period) to one affected site. This 73 mg dose equals a 5-inch ribbon of cream not greater than 1/2 inch in width, which should be rubbed thoroughly into the hair over the joint or affected site using gloved hands. Administration of diclofenac cream should be discontinued 12 hours prior to competing. Do not apply diclofenac cream in combination with any other topical preparations including DMSO, nitrofurazone or liniments, and do not use on an open wound. Diclofenac cream should not be administered for more than 10 successive days.

VIO405.3 Flunixin (an NSAID) - The maximum permitted plasma concentration of Flunixin is 1.0 microgram per milliliter.

Guidelines: When Flunixin Meglumine (Banamine®) is administered, the dose should be accurately calculated according to the actual weight of the animal. Each 24 hours, not more than 0.5 milligram per pound of body weight should be administered. For a 1,000 pound animal, the maximum daily dose is 500 milligrams, which equals two 250 milligram packets of granules, or one 500 milligram packet of granules, or 500 milligrams of the oral paste (available in 1,500 milligram dose syringes), or 10.0 cc of the injectable (50 milligrams per milliliter). No part of a dose should be administered during the twelve (12) hours prior to competing. Any medicated feed must be consumed and/or removed at least twelve

(12) hours prior to competing. The medication should not be used for more than five successive days.

VIO405.4 Ketoprofen (an NSAID) - The maximum permitted plasma concentration of Ketoprofen is 40.0 nanograms per milliliter.

Guidelines: When Ketoprofen (Ketofen®) is administered, the dose should be accurately calculated according to the actual weight of the animal. Each 24 hours, not more than 1.0 milligram per pound of body weight should be administered. For a 1,000 pound animal, the maximum daily dose is 1.0 gram, which equals 10.0 cc of the injectable (100 milligrams per milliliter). No part of a dose should be administered during the twelve (12) hours prior to competing. The medication should not be used for more than five successive days.

VIO405.5 Meclofenamic Acid (an NSAID) - The maximum permitted plasma concentration of Meclofenamic Acid (Arquel®) is 2.5 micrograms per milliliter.

Guidelines: When Meclofenamic Acid is administered, the dose should be accurately calculated according to the actual weight of the animal. Each 12 hours, not more than 0.5 milligram per pound of body weight should be administered, preferably less. For a 1,000 pound animal, the maximum 12 hour dose is 0.5 gram, which equals one 500 milligram packet of granules. The medication should not be used for more than five successive days.

VIO405.6 Naproxen (an NSAID) - The maximum permitted plasma concentration of Naproxen is 40.0 micrograms per milliliter.

Guidelines: When Naproxen is administered, the dose should be accurately calculated according to the actual weight of the animal. Each 24 hours, not more than 4.0 milligrams per pound of body weight should be administered. For a 1,000 pound animal, the maximum daily dose is 4.0 grams, which equals eight 500 milligram tablets. No part of a dose should be administered during the twelve (12) hours prior to competing. Any medicated feed should be consumed and/or removed at least twelve (12) hours prior to competing. The medication should not be used for more than five successive days.

VIO405.7 Firocoxib (Equioxx) (an NSAID) - The maximum permitted plasma concentration of Firocoxib (Equioxx) is 0.240 microgram per milliliter.

Guidelines: When Firocoxib (Equioxx) is administered, the dose should be accurately calculated according to the actual weight of the animal. For a 1,000 pound animal, the maximum daily does is 45.5 milligrams, which equals 0.1 milligram per kilogram of body weight once daily. No part of a dose should be administered during the 12 hours prior to competition. Firocoxib (Equioxx) should not be administered for more than 14 successive days.

VIO405.8 Acetazolamide - This medication may only be administered to horses documented through DNA testing to be positive (N/H or H/H) for HYPP (Hyperkalemic Periodic Paralysis). While these rules do not contain a maximum allowable plasma concentration level for Acetazolamide, laboratory detection of levels of Acetazolamide that are not consistent with administration in accordance with the following guidelines may result in prosecution of a rule violation.

Guidelines: When Acetazolamide is administered, the dose should be accurately calculated according to the actual weight of the animal. Each 24 hours, not more than 3 milligrams per pound of body weight should be administered. For a 1,000 pound animal, the

maximum daily dose is 3 grams.

VIO405.9 Furosemide or Lasix® - When used must be administered intravenously at least four hours prior to competition.

VIO405.10 Isoxsuprine - **Guidelines:** When administered, the dose should be accurately calculated according to the actual weight of the animal. Each 24 hours, not more than 1.6 milligrams per pound of body weight should be administered (usually divided in two equal doses given 12 hours apart). For a 1,000 pound animal, the maximum daily dose is 1,600 milligrams, which equals 80 20-milligram tablets. No part of a dose should be administered during the four hours prior to competing. Any medicated feed should be consumed and/or removed at least four hours prior to competing.

VIO405.11 Lidocaine/Mepivacaine - This medication may only be used under actual observation of event management (or designated representative) and/or the official show veterinarian, either of which must sign the medication report form, to aid in the surgical repair of minor skin lacerations which, by their very nature, would not prevent the horse from competing following surgery. Medication report form must be filed with show management as required in VIO103 above.

VIO405.12 Dexamethasone - The maximum permitted plasma concentration is 3.0 nanograms per milliliter at the time of competition.

Guidelines: In order to help trainers, owners and their veterinarians achieve compliance with this rule in connection with the therapeutic use of dexamethasone, it should be administered in accordance with the guidelines below. These guidelines include several alternative scenarios for dose time and route of administration. Whenever dexamethasone is administered, the dose should be accurately calculated according to the actual weight of the animal. **Alternative Number 1.** (2.0 mg or less per 100 pounds IV or IM at 12 or more hours before competition). Each 24 hours, not more than 2.0 milligrams of dexamethasone injectable solution per 100 pounds of body weight should be administered intravenously or intramuscularly, preferably less. For a 1,000 pound animal, the maximum daily intravenous or intramuscular dose of dexamethasone injectable solution is 20.0 milligrams, which equals 5.0 milliliters of the injectable solution (4.0 milligrams per milliliter). No part of this dose should be administered during the 12 hours prior to competing. Dexamethasone should not be administered for more than five successive days. **Alternative Number 2.** (0.5 mg or less per 100 pounds IV at 6 or more hours before competition). Each 24 hours, not more than 0.5 milligram of dexamethasone injectable solution per 100 pounds of body weight should be administered intravenously, preferably less. For a 1,000 pound animal, the maximum daily intravenous dose of dexamethasone injectable solution is 5.0 milligrams, which equals 1.25 milliliters of the injectable solution (4.0 milligrams per milliliter). No part of this dose should be administered during the six hours prior to competing. Dexamethasone should not be administered for more than five successive days. **Alternative Number 3.** (1.0 mg or less per 100 pounds orally at 6 or more hours before competition). Each 24 hours, not more than 1.0 milligram of dexamethasone powder per 100 pounds of body weight should be administered orally, preferably less. For a 1,000 pound animal, the maximum daily oral dose of dexamethasone powder is 10.0 milligrams, which equals one packet of dexamethasone powder (10.0 milligrams per packet). No part of this dose should be administered

during the 6 hours prior to competing. Any medicated feed should be either consumed or removed at least six (6) hours prior to competing. Dexamethasone should not be administered for more than five successive days.

VIO406. Administration of these conditionally permitted therapeutic medications does not require that the horse be withdrawn and kept out of competition for a period not less than 24 hours after the medication is administered, nor is there a requirement that a medication report be filed with show management, except when Lidocaine/Mepivacaine is used per VIO405.II above.

VIO500. SUSPENSION: Any member may be suspended and denied AQHA privileges and any nonmember may be denied AQHA privileges by AQHA's Executive Vice President for:

VIO500.1 failure to pay when due any obligation owing to AQHA, including, but not limited to, obligation(s) owed to *The American Quarter Horse Journal* and *America's Horse*;

VIO500.2 failure to pay when due any obligation owing to an AQHA-approved affiliate; or an AQHA-approved show; or

VIO500.3 giving a worthless check for entry fees, stall fees, office charges, stock charges or any other fees or charges including bank charges for returned check connected with the exhibition of horses.

VIO501. Prior to a suspension or denial of privileges, AQHA will provide written notification to the member or nonmember of their outstanding obligation per VIO500.2-3. Unless within 31 days after date of such notice, the member or nonmember disputes the validity of the obligation or any portion thereof, AQHA will assume the obligation to be valid and may proceed with a suspension or denial of AQHA privileges. If, within 31 days of date of such notice, a member or nonmember notifies AQHA in writing that the obligation or a portion thereof is disputed, AQHA will obtain a verification of the obligation, and AQHA will mail to the member or nonmember a copy of such verification. If the member or nonmember does not fully pay the obligation within 15 days of date of such verification of the obligation, AQHA will assume the obligation to be valid and may proceed with a suspension or denial of AQHA privileges.

VIO502. Upon suspension and/or denial of privileges by the Executive Vice President, the name, address, city and state of such member or nonmember and description of disciplinary action may be published in *The American Quarter Horse Journal* or on AQHA's official web site, aqha.com." Any suspension and/or denial of AQHA privileges under this section shall terminate upon full payment of the obligation due.

VIO505. DISCIPLINARY AND APPEAL PROCEDURE.

Executive Committee Jurisdiction: The Executive Committee is the forum within AQHA that, initially or ultimately, hears or reviews evidence of alleged violation of rules and regulations by members or nonmembers, decides all matters pertaining to registration of horses, and hears appeals from other committee action. A member may be disciplined, suspended, fined and/or expelled from AQHA and any nonmember may be denied any or all AQHA privileges. Registration certificates may be altered or cancelled and registration applications denied. Proof necessary to establish a rule violation or registration ineligibility is that quantum of proof that would lead a reasonable person to believe the matter alleged in the notice of hearing is established by the credible evidence admitted before the Executive Committee. A majority vote of the Execu-

tive Committee shall determine guilt, and its decision and action shall be final and binding on all parties.

VI0510. EXTENT OF SANCTION: In regard to any violation of AQHA rules and regulations, the Executive Committee shall have jurisdiction to invoke sanction, including revocation or denial of membership privileges, revocation of participation privileges in all AQHA-approved events for a definite or indefinite period, denial of privilege of access or presence on show grounds of an AQHA-approved show, and in addition, assessment of fine not to exceed \$10,000. Executive Committee sanction may include denial of privilege to advertise in AQHA's official publications.

VI0515. ADMISSIBILITY OF EVIDENCE AND SUFFICIENCY OF PROOF: Proceedings before the Executive Committee shall be informal, and rules of evidence, both at common law or provided by Texas rules of civil or criminal evidence, need not be strictly observed. The standard by which admissibility is determined is whether the evidence is such that an ordinarily prudent person is willing to rely upon it. As an AQHA member, the owner or lessee of an American Quarter Horse, or participant at an AQHA-approved event, and a person appearing before the Executive Committee, a standing committee or any subcommittee, agrees that all witnesses and participants in such hearing shall be immune from any civil liability whatsoever, including, but not limited to, libel, slander, invasion of privacy, defamation or product disparagement, for testimony given in the course of the preparation for or at the hearing.

VI0520. ABSOLUTE RESPONSIBILITY: AQHA rules pertaining to prohibition of drugs or surgical alteration provide for absolute responsibility for a horse's condition by an exhibitor, trainer, or Absolutely Responsible person or Responsible Party as affirmed by AQHA rules, whether or not such person was actually instrumental in, or had actual knowledge of, the administration of such drug or surgery, thereby making such person eligible for possible disciplinary action upon proof of the presence of such drug by laboratory analysis or existence of surgical alteration. This rule of procedure for disciplinary action pertains to drug or surgical alteration cases in regard to notice, hearing and effect of suspensions or other sanctions, but burden of proof and presumptions as contained in said drug or surgical alteration rules specifically govern such cases.

VI0521. An owner or lessee of a registered American Quarter Horse may be held responsible for the actions of all third parties in whose care the owner or lessee places his/her horse, including, but not limited to, trainers, agents, representatives, exhibitors and employees. When such third party is convicted of a violation of AQHA rules involving an owner or lessee's horse, or if an owner or lessee acquires personal knowledge of such rule violation by the third party, the owner or lessee is responsible to take such prompt and reasonable action as to protect his/her horse. An owner or lessee may be disciplined in accordance with the rules contained herein, including the enhancement of penalty rule, for failure to take such prompt and reasonable action.

VI0600. NOTICE OF HEARING: Anyone accused of any violation shall be given not less than 15 days notice of a time and place for hearing such accusation by the Executive Committee at which hearing he shall have the opportunity, in person and by counsel, to present evidence in his own behalf and to hear and refute evidence against him. Such notice is deemed received when delivered according to AQHA's general notice procedure.

VI0610. TEMPORARY SUSPENSION: Pending final hearing by the Executive Committee, the Executive Vice President may, by giving written notice of his action:

VI0610.1 temporarily suspend such member, the effect of which shall be to deny him further AQHA privileges until the Executive Committee can hear the matter and take the appropriate disciplinary action; and

VI0610.2 temporarily suspend the registration of the horse in question, and upon AQHA request, the owner or lessee shall return the registration certificate to the Executive Vice President, pending final determination of its validity, the effect of which shall be to suspend participation privileges in AQHA-approved events.

VI0620. PUBLICATION: When a member is disciplined, suspended or expelled, or a nonmember is denied membership privileges, or when a member or nonmember is temporarily suspended by the Executive Vice President pending hearing, the name and address (city and state) of such member or nonmember and description of the disciplinary action may be published in *The American Quarter Horse Journal* or on AQHA's official website, aqha.com. A current list of suspended or disciplined persons shall be maintained at AQHA's office, with the responsibility of each member, horse owner or those involved in transactions concerning American Quarter Horses, to contact AQHA for information regarding the membership status of a particular individual or legal entity.

VI0630. CERTIFICATE CANCELLATION: Upon determination that a horse is either ineligible for registration or eligible only upon fulfillment of certain conditions, the registration certificate shall be cancelled or amended upon fulfillment of those conditions. If cancelled, the horse shall not participate in AQHA-approved events. If registration is conditional, the horse shall not participate in AQHA-approved events until those conditions are fulfilled and the registration certificate is reinstated.

VI0640. ENHANCEMENT OF PENALTY: The Executive Committee may enhance suspension, penalty and/or fine of repeat offenders of AQHA rules and regulations and include owners or lessees who have repeatedly placed the care or custody of their horses with such repeat offenders, according to guidelines that it may, from time to time, set to a maximum of indefinite suspension of membership privileges and/or fine to a maximum of \$5,000. Such disciplinary actions are enhancements of those disciplinary actions listed in VI0510.

VI0641. An owner or lessee of a registered American Quarter Horse is responsible for the actions of all third parties in whose care the owner or lessee places his horse, including, but not limited to, trainer or exhibitor. When such third party is convicted of a violation of AQHA rules involving owner's or lessee's horse, or if an owner or lessee acquires personal knowledge of such rule violation by the third party, the owner or lessee is responsible to take such prompt and reasonable action as to protect his horse and AQHA from repeat offenses. Failure by the owner or lessee to take such action, or repeat offenses by such third parties involving the owner's or lessee's horse or horses, constitutes the owner or lessee eligible for inclusion in enhancement of penalty under AQHA disciplinary rules.

VI0650. EFFECT OF MEMBERSHIP SUSPENSION: On or after such time as any person has been suspended, expelled or denied AQHA privileges, in addition to other provisions of the AQHA

Official Handbook or policy of AQHA, the following restrictions set forth below shall apply. For purposes of this subsection, the term "Family" shall mean the person that has been suspended, expelled or denied AQHA privileges, that person's spouse and that person's child.

VI0650.1 That person shall not participate, and shall be ineligible to participate, in any AQHA-approved event. Such person shall be ineligible to hold approved judges credentials or any other AQHA accreditation.

VI0650.2 No horse that is recorded in the name of such person is eligible to participate in any AQHA-approved event such as shows or races. No horse that is recorded in the name of such person's Family is eligible to participate in such AQHA-approved events unless waived by the AQHA Executive Committee.

VI0650.2.1 UNREGISTERED HORSES: In the case of the sale by a suspended person to an innocent third party purchaser not the owner at time of foaling, when accompanied by written transfer from the suspended owner to the registration applicant; or

VI0650.2.2 REGISTERED HORSES: In the case of the sale by a suspended person, ownership which has not been recorded in the suspended person's name, to record ownership into the suspended person and transfer to the innocent third party purchaser.

VI0650.3 That person, that person's Family or entity owned in whole or part by that person's Family shall not register any horse with AQHA. Transfers to that person, that person's Family or entity owned in whole or part by that person's Family shall not be processed. To prevent hardship on innocent third parties, AQHA has discretion to waive procedural requirements if all other registration or transfer requirements of AQHA are fulfilled.

VI0650.4 Signatures will be honored on registration applications, transfer reports and bills of sale for the purpose of allowing that person, that person's Family, or entity owned in whole or part by that person's Family to transfer horses recorded in their ownership at the time of the disciplinary action to innocent third parties.

VI0650.5 No horse shall be registered that is either sired by a horse or out of a mare owned by such suspended person or their Family if such person is under suspension at time of breeding.

VI0650.6 AQHA shall not accept the signature of such person, such person's Family member or entity owned in whole or part by that person's Family on registration applications, breeder's certificates or stallion breeding reports evidencing breeding taking place on or after date of such disciplinary action.

VI0650.7 Written leases filed with AQHA prior to the time of disciplinary action and covering horses owned by the disciplined person or their Family shall remain valid, and the signature of the lessee shall be accepted during the term of such lease, but for no renewal thereof.

VI0651. During the period of expulsion, suspension or denial of AQHA privileges, failure to comply with these restrictions and any other express conditions or restrictions of said disciplinary action may constitute grounds for further disciplinary action.

VI0655. EFFECT OF SUSPENSION ON PRIVILEGES IN AQHA-APPROVED EVENTS: On or after such time as any person has been denied participation privileges in AQHA-approved events, but his membership privileges are not affected, the following

restrictions shall apply:

VI0655.1 That person shall not be eligible to participate in any AQHA-approved event;

VI0655.2 Horses that are recorded in the name of such person, or owned in whole or in part by such person, are not eligible to participate in any AQHA-approved event;

VI0655.3 That person shall not be eligible to hold approved judges credentials or any other AQHA accreditation.

VI0656. During the period of denial of AQHA privileges, failure to comply with these restrictions and any other express conditions or restrictions of said disciplinary action may constitute grounds for further disciplinary action.

VI0657. If denial or revocation of show privileges includes denial of access or presence on show grounds, the person shall refrain from entry or presence on show grounds of any AQHA-approved show grounds during the term of his or her suspension. Failure to comply with such restriction may result in (1) further disciplinary action against such person and (2) disqualification of exhibitors and horses that such person helped prepare for the show or assisted at the show.

VI0658. Every person who is suspended or otherwise disciplined by one of the below specified associations may be suspended or disciplined by AQHA, upon official notice to AQHA by the disciplining association, for the following offenses:

VI0658.1 unsportsmanlike conduct at a show or contest;

VI0658.2 inhumane treatment of horses; or

VI0658.3 prohibited surgical procedure or injection or administration of foreign substances or drugs that could affect a horse's performance or alter its natural conformation or appearance.

VI0700. The following associations for which reciprocity shall be given and which have enacted rules which are materially and substantially similar to AQHA rules are:

- Alberta Quarter Horse Association
- American Paint Horse Association
- Barrel Futurities of America
- California Department of Food & Agriculture
- Cowboy Mounted Shooting
- Federation Equestre International
- International Buckskin Horse Association
- National Cutting Horse Association
- National Reined Cow Horse Association
- National Reining Horse Association
- National Snaffle Bit Association
- Ontario Quarter Horse Association
- Palomino Horse Breeders of America
- United States Team Penning Association
- United States Equestrian Federation
- World Conformation Horse Association

AQHA Show Fines and Penalties
Regarding Inhumane Treatment and Unsportsmanlike Conduct – VIO200-204 & VIO220

	Level 1 Mild	Level 2 Moderate	Level 3 Severe
White=First Warning Yellow=Warning Card Red=Show Grounds Removal Card Example: 1 offense on 3 horses = 3 offenses or 3 offenses on one horse = 3 offenses	Warning – no fine or penalty Steward issues white warning card. Name placed in warning database	Fine \$500 - \$15,000	Fine \$5,000 - \$25,000 Suspension up to Permanent Expulsion Mandatory Probation Name placed in warning database
1st Offense	Suspension up to 36 months Mandatory Probation Name placed in database		
2nd Offense			
3rd Offense			
More than 3 offenses in 120 days or more than 4 offenses in a 12 month period.		Fine \$5,000 - \$25,000 Suspension up to Permanent Expulsion Mandatory Probation Name placed in warning database	

The AQHA Executive Committee has ultimate authority to impose less or more severe penalties as compared to this chart as it deems necessary. This chart may be modified at any time by AQHA's Executive Committee. All fines and penalties are cumulative and run consecutively in the case of multiple offenses. Habitual offenders are subject to the severest fines and penalties above.

REGISTRATION RULES AND REGULATIONS

REG100. STUD BOOK. The official Stud Book of the American Quarter Horse Association consists of horses issued registration certificates based upon their parentage. These certificates shall be either in the Numbered registry or in that of the Appendix, depending upon the registration status of the sires and dams. Prior to 1962, foals registered with AQHA might have been in the registries labeled Numbered, Permanent, Tentative, Old Appendix and New Appendix, but only the Numbered and Appendix exist today.

REG100.1 General Provisions Payment is required at the time of processing and payable in U.S. funds only. Mailing address: P.O. Box 200, Amarillo, Texas 79168. Overnight Delivery Address: 1600 Quarter Horse Drive, Amarillo, Texas 79104. www.aqha.com. 806-376-4811.

REG100.2 Through the payment of a membership fee to AQHA, an individual acknowledges that membership in AQHA is voluntary and agrees to be bound by all terms and conditions provided in this Official Handbook.

REG100.3 A required form must be properly completed in its entirety and signatures provided as requested.

REG101. Assignment of Burden of Persuasion for Registration Eligibility. In all proceedings concerned with or affecting the registrations and records of AQHA, and in all disciplinary actions, the burden of resolving any doubt as to the true parentage, identification of a horse or qualification for registration shall be upon the applicant, owner, lessee or other member or members involved. The determination, decision and action of the Executive Committee upon all such questions shall be final and binding upon all parties. As the above specified party or parties have the burden of persuasion, by failure to present relevant evidence concerning such questions to AQHA or at a hearing scheduled to resolve the question, they shall be deemed to have waived their right to later present such evidence to a court of law, if they seek judicial review of AQHA's action.

REG101.1 Burden of Persuasion. The burden of persuasion of a controverted registration fact is that amount of evidence admissible under AQHA's rules pertaining to disciplinary procedure, which will convince an ordinary prudent person.

REG101.2 Parentage Testing. Genetic tests may be required as the Executive Committee determines, including, but not limited to, questions of true parentage or identification of horses. Taking into consideration the results of such tests, and other information as may be available, the Executive Committee may authorize such corrections in the records as may be determined necessary or appropriate.

REG101.3 Conditional Issuance. The certificate evidencing registration is issued on the following condition, which shall be printed on the face thereof: "This certificate is issued in reliance on the written application signed and attested by the individual specified by AQHA rules; and upon the express condition that AQHA has the privilege to correct and/or cancel the certificate for cause under its rules and regulations."

REG101.4 Registration of Offspring. In order to protect innocent, third party owners of offspring that are the product of breedings of previously eligible parents taking place prior to date of cancellation of the registration certificate of a parent or parents,

such offspring are eligible for registration; however, a previously issued registration certificate shall be recalled to designate the pedigree behind the cancelled parents as “unknown.”

REGIO2. REGISTRATION PROCEDURES. To register a horse:

REGIO2.1 The record owner or record lessee of the foal's dam at time of foaling (at time of breeding if an embryo transfer foal) is responsible for submitting a properly completed and signed registration application and a completed and signed breeder's certificate. In the event a frozen embryo permit is used to register a foal, the owner of the permit shall sign the registration application as the owner at time of foaling.

REGIO2.2 Each registration application must be completed and signed by the owner of the foal's dam at the time of foaling (at time of breeding if an embryo transfer foal) by the dam's lessee (if a record of the lease is on file with AQHA) or by a person authorized to sign for the owner or lessee (if a record of the authorization is on file with AQHA) for the foal to be eligible for registration. In the event a frozen embryo permit is used to register a foal, the owner of the permit shall sign the registration application as the owner at time of foaling.

REGIO2.3 If one parent of the horse being registered is a Thoroughbred, a photocopy of both sides of that Thoroughbred's registration certificate issued by The Jockey Club of North America, or any Thoroughbred registry recognized by The Jockey Club of North America, must be on file in AQHA's office to show correct ownership so any required information may be verified. Thoroughbreds used for breeding after January 1, 1997, must comply with AQHA white requirements found in REGIO9.8 and AQHA may require four color photographs clearly showing all white markings. As to subsequent registration applications for offspring, if the application indicates an ownership change of the Thoroughbred, an additional photocopy of both sides of its registration certificate showing such change in ownership must be filed with AQHA.

REGIO2.4 Each horse will be registered to the name of the record owner (or record lessee) of the dam at the time the horse was foaled (if foal is the result of embryo transfer refer to REGII2 and REGII3), and that owner or lessee (or authorized agent) must sign the registration application. That record owner or lessee must have a current membership when the application is submitted or a non-member registration fee will be required.

REGIO2.5 When a registration application shows the horse to be registered has white markings beyond the prescribed lines in REGIO9.8, excessive white markings or white spot or spots, pictures of the horse shall be required and the horse may be inspected to determine if parentage verification is required before the application is processed.

REGIO2.6 When a horse is inspected for possible excessive white markings, the owner will pay AQHA a \$50 inspection fee prior to the inspection. If the horse is found to be within the limitations described in REGIO9.8 and its actual markings are shown to be as indicated on the registration application and other material submitted, the inspection fee will be refunded.

REGIO2.7 If after the horse is foaled, changes of ownership occur, then each change requires a properly completed and signed transfer report.

REGIO2.8 Parentage must be verified through genetic testing

before a foal can be registered if:

REG102.8.1 either of the parents was less than 2 years of age at time of conception;

REG102.8.2 it was the result of an embryo/oocyte transfer;

REG102.8.3 it was conceived by the use of cooled transported semen;

REG102.8.4 it was conceived by the use of frozen semen;

REG102.8.5 it was more than 48 months of age at time application for registration is made;

REG102.8.6 its dam was exposed to more than one stallion within a 30 day time period;

REG102.8.7 it has white markings exceeding the limitations specified in REG109.8;

REG102.8.8 it is foaled January 1, 2007, or after and is a descendant of Impressive 0767246 as required in REG109.3;

REG102.8.9 the Executive Committee has justifiable cause to question its parentage.

REG102.9 Registration applications for horses foaled in a country recognized by AQHA as an international affiliate should be submitted for processing to the affiliate and submission to AQHA for approval. Properly completed registration applications received by AQHA without evidence of such processing will require notification by AQHA to the recognized international association that such application has been received and processed. Applicant shall not be required to pay an additional fee, other than usual AQHA registration fees, for this service and shall not be required to be a member of the international association; however, those applicants who are not AQHA members will be subject to AQHA's nonmember fee schedule.

REG103. NAMING A HORSE. Each horse for which registration is applied must be given a name acceptable to AQHA.

REG103.1 The name must not exceed 20 characters, including letters, numbers and blank spaces.

REG103.2 Arabic numerals are permitted as a suffix.

REG103.3 Punctuation marks are not permitted.

REG103.4 A name may be reused if all of the following criteria are met by the horse originally issued the name:

REG103.4.1 is deceased as evidenced by AQHA records;

REG103.4.2 does not have a performance record (show or race);

REG103.4.3 has not received any AQHA special achievement recognition award or alliance recognition that appear on AQHA records as an award;

REG103.4.4 does not have offspring with a performance record (show or race) nor any AQHA special achievement recognition award or alliance recognition that appear on AQHA records as an award;

REG103.4.5 does not have produce or get younger than 10 years of age.

REG103.5 A name may be reserved for a period of one year from the date AQHA receives a written reservation request and the applicable non-refundable fee. Should the name not be used within that time period, the name will be released without further notice by AQHA unless, prior to the expiration of the reservation, the name is reserved again for another one year period per the procedure immediately above.

REG104. OBTAINING A NUMBERED CERTIFICATE.

Except as otherwise limited on proper compliance with the rules and regulations of AQHA, a stallion, mare, gelding or spayed mare may be registered in the Numbered section of the Stud Book that:

REGIO4.1 has a Numbered American Quarter Horse sire and a Numbered American Quarter Horse dam. Such horse, when registered, shall receive a registration number. For horses foaled on or after January 1, 1992, any undesirable trait or condition commonly considered a 'Genetic Defect' as listed in REGIO9 shall be recorded on the registration certificate.

REGIO4.2 previously has been listed in the Appendix, and the following conditions are met: (1) the horse has qualified for Register of Merit in AQHA-approved events not restricted in any way (youth and/or amateur Register of Merit do not qualify a horse for advancement); (2) AQHA has received a signed statement from a licensed veterinarian certifying that the horse does not have a parrot mouth per REGIO9.1 and (3) if the horse is a stallion, AQHA has received a signed statement from a licensed veterinarian certifying it is not cryptorchid per REGIO9.2. Horses having parrot mouth, cryptorchidism, HYPP or excessive white markings are not eligible for advancement. When a horse is advanced, it is necessary to surrender the registration certificate before a Numbered certificate can be issued.

REGIO4.3 was previously listed in the Appendix and attains a registration number, any offspring listed in the Appendix shall on that date become eligible for advancement to the Numbered registry. Advancement of such offspring to the Numbered registry shall be on request from the record owner and accompanied by the Appendix registration certificate, or

REGIO4.4 was foaled in an international country having a Quarter Horse Association recognized by the AQHA that operates its own stud book; was issued a registration certificate by such international association; and which traces to a minimum of 93.75 percent (15/16) lineage to horses issued Numbered registration certificates by AQHA. To receive such Numbered certificate from AQHA, the horse's owner must make application through the recognized international association in the country he resides to supply AQHA all required proof of breeding and identification. Registration fee shall be \$35, or \$75 if owner does not have a current membership.

REGIO5. OBTAINING AN APPENDIX CERTIFICATE.

Except as otherwise limited on proper compliance with the rules and regulations of AQHA, a stallion, mare, gelding or spayed mare that has one parent with an AQHA number and the other parent registered in the Appendix, The Jockey Club of North America or any Thoroughbred registry recognized by The Jockey Club of North America may be listed in the Appendix.

REGIO5.1 For horses foaled on or after January 1, 1992, any undesirable trait or condition commonly considered a 'Genetic Defect' as listed in REGIO9 shall be recorded on the registration certificate.

REGIO5.2 When application is made to register a foal sired by an unnamed Thoroughbred stallion or out of an unnamed Thoroughbred mare, that stallion or mare must be named with approval of The Jockey Club before the registration of the foal can be completed.

REGIO5.3 Horses listed in the Appendix shall be eligible to compete in AQHA-approved events subject to meeting the requirements established for these events.

REGIO5.4 Any stallion or mare listed in the Appendix that cannot

qualify for at least one of the Registers of Merit shall remain in the Appendix, unless both parents have qualified for a Numbered AQHA registration certificate and the foal meets all other requirements.

REG105.5 A horse is eligible to receive an Appendix certificate if foaled in an international country with a Quarter Horse association recognized by AQHA which operates its own stud book; was issued a registration certificate by such association; and which traces to a minimum of 93.75 percent (15/16) lineage to horses registered with the AQHA and the Jockey Club of North America or any Thoroughbred registry recognized by the Jockey Club of North America. To receive such Appendix certificate from AQHA, the horse's owner must make application through the recognized international association in the country he resides to supply AQHA all required proof of breeding and identification. Registration fee shall be \$35, or \$75 if owner does not have a current membership.

REG106. HORSES NOT ELIGIBLE FOR REGISTRATION INCLUDE:

REG106.1 offspring resulting from an Appendix registered sire or dam bred to another Appendix registered horse;

REG106.2 offspring resulting from an Appendix registered sire or dam bred to a Thoroughbred sire or dam;

REG106.3 a horse having white markings beyond the proscribed lines as listed in REG109.8 shall be subject to cancellation where the registration application fails to indicate or misrepresents the horse's actual markings and the horse cannot be parentage verified;

REG106.4 foals born on or after January 1, 2007, and testing homozygous positive for HYPP (H/H).

REG107. EXTRAORDINARY REGISTRATION

REG107.1 The Executive Committee shall have authority to declare eligible for registration as breeding stock only, a horse whose registration certificate has been previously cancelled, but, in the majority opinion of the Executive Committee, is outstanding by performance or produce, and thus worthy of registration as breeding stock, though lacking some technical requirement of AQHA rules to allow it to remain registered.

REG107.1.1 "Outstanding by performance or produce" shall mean that the horse, before its certificate was cancelled, attained the designation of "AQHA Superior Event Horse," or that one or more of its offspring attained such designation.

REG107.1.2 The Executive Committee shall accept as breeding stock only those horses that have a sire or dam which have a Numbered certificate and (1) the other parent so registered; or (2) listed in the AQHA Appendix registry; or (3) registered with The Jockey Club of North America or any Thoroughbred registry recognized by The Jockey Club of North America; or (4) is proven to the satisfaction of the Executive Committee by genetic testing to be eligible by pedigree for a registration status named above.

REG107.1.3 A horse is not eligible for consideration under this rule if it has any condition listed in REG109 as a genetic defect.

REG107.2 An owner may make application for consideration under this rule by payment of the requisite fee and submission of such photographs, reports of pedigree substantiation and other supporting materials as the Executive Committee may, from time to time, require.

REG108. GENETIC TESTING

REGIO8.1 If there is justifiable cause to question parentage of a foal, the Executive Committee may require the foal, sire and dam to be genetically tested, the expenses of which shall be allocated as the Executive Committee determines. The results of this test, together with other available information, may be taken into consideration by the Executive Committee in its determination of the foal's parentage as recognized by AQHA. Such genetic testing shall be done by an organization approved by AQHA.

REGIO8.2 The owner or lessee of a stallion exposed to one or more mares, shall, at his own expense, file with AQHA a written report of the stallion's genetic type, obtained from a laboratory approved by AQHA, and in accordance with procedures adopted by AQHA. Once such type is filed with AQHA, it is not necessary to repeat such filing annually, except as requested by AQHA. This type must be on file with AQHA prior to the registration of any foal sired by such stallion from mares covered in REGIO8.3 below.

REGIO8.3 A genetic type must be on file with AQHA for any mare foaled on or after January 1, 1989, prior to the registration of any foal produced by them.

REGIO8.4 All stallions having 25 or more mares on their 2014 breeding report are required to have a genetic disease panel test on file with AQHA prior to the registration of their foals resulting from breeding's occurring after January 1, 2014.

REGIO8.5 All stallions are required to have a genetic disease panel test on file with AQHA prior to the registration of their foals resulting from breeding's occurring after January 1, 2015.

REGIO8.6 Effective January 1, 2015, only those parentage verified foals whose sire and dam have tested negative for all genetic diseases on the genetic panel test will receive the designation "N/N" for each of the genetic tests.

REGIO9. GENETIC DEFECTS AND UNDESIRABLE TRAITS.

In accordance with its Mission Statement and Welfare Policy Statement, AQHA endeavors to educate its membership and protect the welfare and integrity of the breed. Part of such endeavor includes AQHA's efforts associated with the research, identification and promulgation of rules and regulations concerning genetic defects and undesirable traits through AQHA's governance process. In that regard, researchers have noted that the American Quarter Horse does not have more genetic diseases than other equine breeds rather, AQHA has just been proactive and taken the lead at identifying genetic diseases affecting the American Quarter Horse breed. The conditions listed below and commonly considered undesirable traits or genetic defects by the Board of Directors shall be indicated on the registration certificate for horses foaled on or after the indicated date, once the condition is known. Upon discovery, the owner shall immediately report such condition to AQHA for marking its condition on the registration certificate as provided below. Failure to timely report these conditions may subject the owner to possible disciplinary action. Genes come in pairs; each parent contributes one copy to the offspring. With respect to the autosomal dominant genetic diseases listed below (HYPP, PSSM, and MH), only one defective gene is necessary to express the genetic disease in question. Such gene can be inherited from either of the parents or from both of the parents. With respect to autosomal recessive genetic diseases listed below (GBED and HERDA), typically, two copies of an abnormal gene (two copies = a pair) must be present in order for the horse to show signs of the

genetic defect in question. Horses with only one copy of the defective gene are considered “carriers”.

REG109.1 Parrot Mouth - either overshot or undershot, defined by the American Association of Equine Practitioners as “no occlusal contact between the upper and lower central incisors.” Designation effective for foals born on or after January 1, 1992.

REG109.2 Cryptorchid - meaning less than two visible testicles descended into the scrotum. Designation effective for foals born on or after January 1, 1992.

REG109.3 Hyperkalemic Periodic Paralysis (HYPP) - designation effective for foals born on or after January 1, 1998. HYPP is an inherited autosomal dominant genetic disease. A muscular disease caused by a hereditary genetic defect that leads to uncontrolled muscle twitching or profound muscle weakness, and in severe cases, may lead to collapse and/or death. According to research, this condition exists in certain descendants of the stallion Impressive, AQHA registration number 0767246.

REG109.3.1 The following notification shall be placed on registration certificates of foals descending from the stallion Impressive or any other bloodline determined to carry the HYPP gene: “This horse has an ancestor known to carry HYPP, designated under AQHA rules as a genetic defect. AQHA recommends testing to confirm presence or absence of this gene.” When the parent(s) tracing from the HYPP line has tested negative for HYPP with an appropriate designation appearing on their registration certificate, the above notification is not required, and will, instead, be substituted by the designation “N/N”; or, after testing negative for the gene, the notification may be substituted by the designation “N/N” upon request of the owner at his or her expense.

REG109.3.2 Mandatory testing for HYPP. At such time as AQHA requires mandatory parentage verification of any foals to be registered in either the Numbered or Appendix registry, per REG102.8 any foal tracing to bloodlines known to carry the HYPP gene shall be tested for HYPP at the time the genetic testing for parentage is performed. The results will be designated on the registration certificate in lieu of the above notification. Such testing will not be necessary if the foal’s closest ancestors (parents), tracing to the HYPP line, have been tested negative and designated on their registration certificates; these foals will automatically be designated “N/N” on their registration certificate.

REG109.3.3 Effective with foals born on or after January 1, 2007, all descendants of the stallion Impressive, #0767246, shall be required to be parentage verified and HYPP tested, subject to the conditions in REG109.3.2 above. Any foal testing homozygous positive for HYPP (H/H) will not be eligible for registration with AQHA.

REG109.4 Polysaccharide Storage Myopathy (PSSM) is an inherited autosomal dominant genetic disease that causes excess glycogen storage in muscles which can result in tying-up, muscle tremors, and/or gait abnormalities.

REG109.5 Glycogen Branching Enzyme Disease (GBED) is an inherited autosomal recessive disease that terminates protein synthesis which can result in late-term abortions or death in foals shortly after they are born.

REG109.6 Hereditary Equine Regional Dermal Asthenia (HERDA), also known as Hyperelastosis Cutis (HC), is an inher-

ited autosomal recessive disease that weakens collagen fibers that connect the skin of a horse to the rest of the horse. Affected horses can have fragile hyperextensible skin which can result in tears, scars and lesions. Affected horses are also known to exhibit impaired healing to such injuries.

REG109.7 Malignant Hyperthermia (MH) is an inherited autosomal dominant disease that causes a life-threatening condition that is usually triggered by exposure to certain drugs used for general anesthesia. In susceptible horses, these drugs can induce an uncontrolled increase in skeletal muscle oxidative metabolism which affects the body's capacity to supply oxygen, remove carbon dioxide, and regulate body temperature, potentially leading to circulatory collapse and death if not treated quickly.

REG109.8 White Markings: A horse having white markings with underlying light skin beyond any one of the following proscribed lines shall be eligible for registration by AQHA only if its parentage verified through DNA typing the offspring, its sire and its dam. Breeders should be aware that the American Quarter Horse, while long recognized, identified and promoted as a solid-colored horse, can and does occasionally produce offspring with overo paint characteristics. Such markings are uncharacteristic of the breed and are considered to be undesirable traits. The following notification shall be placed on registration certificates of horses exceeding these marking limitations: "This horse has white markings designated under AQHA rules as an undesirable trait and uncharacteristic of the breed."

REG109.8.1 A line parallel with the ground drawn around the front leg at the point halfway between the point of the elbow (the center of the olecranon tuberosity or proximal epiphysis of the ulna) and the protrusion on the back of the knee (the accessory carpal bone or lateral styloid process).

REG109.8.2 A line parallel with the ground at the center of the gaskin on the hind legs. (The center of the gaskin shall be defined as an imaginary point on the front of the gaskin equidistant between the stifle joint and the center of the hock.) The top point of reference to be the bony protrusion on the inside (medial) of the stifle region (technically known as the medial condyle of the tibia) and the most prominent bony protrusion at the top and inside of the hock (technically known as the medial malleolus of the tibia).

REG109.8.3 A line around the horse's neck immediately behind the poll and through the midpoint of the throat latch.

REG109.8.4 Within an area described as two inches on either side of the ventral midline, beginning at a point midway between the front legs and extending to, and including, the sheath and udder.

REG109.8.5 Additionally, there is allowed a single area of white marking with underlying light skin, such that it can be completely covered with a disk one inch in diameter, either free standing on the horse's body or being a portion of white marking extending past the above proscribed lines.

REG109.8.6 Areas of white, pink or mottled skin located on the horse's genitalia, including the sheath or udder, in the axillary region (armpits) or inside the hind legs, including the inner surface of the hindquarters up to and including the ventral surface of the tail, and which are not readily visible when the horse is in

a standing position are not considered excessive white markings as described in REG109.8 above.

REG110. STALLION BREEDING REPORT

REG110.1 The owner of every American Quarter Horse stallion must make a written report showing the exposure of all American Quarter Horse mares and Thoroughbred mares exposed to said stallion since the previous November 30. The owner of every listed Thoroughbred stallion must make a written report showing the exposure of all American Quarter Horse mares since the previous November 30. The stallion breeding report must be postmarked or delivered to AQHA on or before November 30 of the breeding year; reports for stallions standing south of the equator must be postmarked or delivered to AQHA on or before June 30 of the breeding year. If a stallion is leased during the breeding season according to AQHA records, the lessee must make this written report.

REG110.2 This report shall include the names, registration numbers and breeding dates for all mares owned by the owner of the stallion as well as mares owned by other parties. Persons using a retained semen rights permit per REG111 must file a stallion breeding report or supplemental stallion breeding report listing mares bred using the stored semen by November 30 of the breeding season.

REG110.3 Only one foal can be registered per mare listed on a stallion breeding report. In order for multiple foals resulting from breedings to a particular mare to be registered, the mare must be listed multiple times (with breeding dates) on the stallion breeding report corresponding to the number of foals sought to be registered.

REG110.4 Thirty days must elapse between exposure to different stallions for foals to be eligible for registration. Refer to REG102.8.6.

REG110.5 If the stallion for which the report being filed is a Thoroughbred, a photocopy of both sides of that Thoroughbred's registration certificate issued by The Jockey Club of North America or any Thoroughbred registry recognized by The Jockey Club of North America, must be recorded in AQHA's office showing the correct ownership and photographs clearly showing white markings as required by REG102.3.

REG111. COOLED TRANSPORTED SEMEN AND FROZEN SEMEN

REG111.1 The stallion owner or lessee shall clearly distinguish those mares bred using cooled transported semen or frozen semen on the stallion breeding report.

REG111.2 In the event a stallion owner wishes to (1) transfer a stallion, but retain rights to use frozen semen or (2) keep the stallion and transfer semen right permit(s), he may purchase retained semen rights permits from AQHA. The application for purchase must be on a form provided by AQHA. The application must be signed by the record owner or lessee of the stallion and only the record owner or lessee can purchase retained semen rights permits. Once a stallion is sold, a former owner or lessee cannot purchase additional permits from AQHA.

REG111.2.1 Each of the retained semen rights permits purchased may be used as the breeder's certificate for the registration of only one foal. These permits shall require only the signature of the permit owner. AQHA will record the number of outstanding permits for each individual stallion and that number will be a matter of public record. It is the ultimate responsibility of a prospective buyer to confirm with the seller, the number of out-

standing permit applications as of the date of sale.

REGIII.2.2 The ownership of the retained semen rights permits may be transferred. Each transfer of ownership of the permit shall be recorded by AQHA. The rules of transfer of ownership as per REGI24 for transfer of ownership of a horse shall apply, except the request to transfer ownership of the permit shall be accompanied by the retained semen rights permit instead of the registration certificate.

REGIII.2.3 Purchaser of the retained semen rights permit is responsible for filing the appropriate stallion breeding report as required per REGI10.

REGIII.3 Any foal resulting from the use of cooled transported semen or frozen semen must have its pedigree verified by genetic testing, including sire, dam and foal and/or by other genetic testing as AQHA deems necessary, all expense of which shall be the registration applicant's. In addition, the Executive Committee has the authority to require parentage verification by genetic testing of all foals born on any premise receiving transported semen.

REGIII.4 The Executive Committee has the authority to send representatives to inspect the premises and practices of any person or breeding establishment using artificial insemination and no person shall refuse, upon reasonable request, full access to said premises.

REGIII.5 When a foal is produced by cooled transported semen or frozen semen, such fact will be listed on its registration certificate.

REGIII.6 With respect to a stallion foaled in 2015 or after, the semen of such stallion may not be used beyond 2 calendar years following the year of his death or his being gelded to produce a foal eligible for registration with AQHA.

REGI12. EMBRYO/OOCYTE TRANSFER

REGI12.1 A horse foaled by a mare that is not its genetic dam but transferred to her by embryo/oocyte transfer technique shall be eligible for registration. In addition to other AQHA registration rules, the offspring shall not be eligible for registration unless:

REGI12.1.1 prior to the intended collection of the fertilized egg, record owner or lessee has notified AQHA in writing of its intention to attempt an embryo/oocyte transfer and has paid the proper fee. For mare enrollments received after collection of the embryo/oocyte, but prior to foaling, a late fee of \$25 will be assessed, in addition to regular fees required. For mare enrollments received after foaling, a late fee of \$50 will be assessed, in addition to regular fees required. The mare can be enrolled for her lifetime or the enrollment must be made each year that a transfer is to be performed, and once made, the fee is not refundable, nor can any substitution be made.

REGI12.1.2 its pedigree has been verified through genetic testing of foal, sire and donor mare; and by such other testing as AQHA reasonably deems necessary to verify the validity of the genetic testing, all expense of which shall be the registration applicant's.

REGI12.2 The enrollment notice must be sent by certified mail, return receipt requested, to preserve for the record owner or lessee of the donor mare, the only acceptable proof to AQHA of timely compliance, if such proof is requested.

REGI12.3 In accordance with AQHA-approved procedures, an embryo/oocyte transfer may be transported from the premises

where the donor mare was located at the time of its removal from her for use in a recipient mare at another location. To be eligible for such transportation, notice of intention to transport the embryo/oocyte transfer shall be given AQHA in conjunction with the advanced notice of intended collection specified above.

REG112.4 If a mare is designated with AQHA for embryo/oocyte transfer for a specific year, but the procedure is not attempted in the designated year, AQHA must be notified in writing by December 31 of the designated year that the owner has elected not to attempt embryo/oocyte transfer. Without such notice, a foal produced the following year by designated mare is not eligible for registration without genetic testing for parentage verification. If a mare is enrolled for her lifetime, all of her offspring must be parentage verified before they can be registered regardless of the breeding method used.

REG112.5 In the event a mare owner wishes to (1) transfer a mare, but retain rights to use frozen embryos or oocytes, or (2) keep the mare and transfer frozen embryo or oocyte permit(s), he may purchase frozen embryo permits from AQHA. The application for purchase of a permit must be on a form provided by AQHA. Once a mare is sold, a former owner cannot purchase additional permits from AQHA.

REG112.5.1 The application for a frozen embryo permit must be signed by both the mare owner and the stallion owner at time of breeding. This permit, when used to register a foal, will serve as both the stallion breeding report and the breeder's certificate.

REG112.5.2 Each of the frozen embryo permits purchased may be used for the registration of only one foal. AQHA will record the number of outstanding certificates for each individual mare and that number will be a matter of public record. It is the ultimate responsibility of a prospective buyer to confirm with the seller, the number of outstanding permit applications as of the date of sale.

REG112.5.3 The ownership of the permit may be transferred. Each transfer of ownership of the embryo permit shall be recorded by AQHA. The rules for transfer of ownership as listed in rule REG124 for transfer of ownership of a horse shall apply, except the request for transfer of the permit shall be accompanied by the embryo permit instead of the registration certificate.

REG112.6 When a foal is produced by an embryo/oocyte transfer, such fact will be listed on its registration certificate.

REG112.7 AQHA may inspect the premises and practices of any party using or intending to use embryo/oocyte transfer procedures.

REG112.8 The burden of verifying true parentage is the registration applicant's, and any question of parentage shall be resolved against the registration of a horse carried by a recipient mare through embryo/oocyte transfer.

REG112.9 With respect to a mare foaled in 2015 or after any embryos or oocytes of such mare may not be used beyond 2 calendar years following the year of her death or being spayed to produce a foal eligible for registration with AQHA.

REG113. BREEDER AND BREEDER'S CERTIFICATE

REG113.1 The breeder of a horse is the owner of the dam at the time of service, except when a mare is held under lease at time of breeding and written notification of such lease signed by the lessee and lessor is on file with AQHA, in which event the registration certificate shall show the lessee as the breeder. When a frozen

embryo permit is used to register a foal, the original purchaser of the frozen embryo permit shall be listed as the breeder.

REGII3.2 Registration applications must be accompanied by a completed breeder's certificate signed by the record owner of the sire and the record owner of the dam at the time of service. If a stallion and/or mare is bred while under lease agreement filed with AQHA, the signature of such lessee on the breeder's certificate is required.

A breeder's certificate is not required if:

REGII3.2.1 a properly signed frozen embryo permit is used to register a foal, as the breeder's certificate requirements were met when application to purchase the frozen embryo permit was made;

REGII3.2.2 the same entity is the record owner of sire, dam and foal;

REGII3.2.3 a retained semen rights permit is used to register a foal, AQHA requires only the signature of the permit owner on the permit to verify the service of the sire. Record owner of the dam at time of breeding must sign the appropriate breeder's certificate on the registration application.

REGII3.3 Alteration of information on a breeder's certificate will necessitate verification.

REGII3.4 For a horse covered by a lease filed with AQHA, only the lessee or lessee's authorized agent may sign a breeder's certificate for breedings that occurred during the effective period of the lease.

REGII4. COLORS. Descriptions of American Quarter Horse colors:

REGII4.1 BAY: body color ranging from tan, through red, to reddish brown; mane and tail black — usually black on lower legs.

REGII4.2 BLACK: body color true black without light areas; mane and tail black.

REGII4.3 BROWN: body color brown or black with light areas at muzzle, eyes, flank and inside upper legs; mane and tail black.

REGII4.4 SORREL: body color reddish or copper-red; mane and tail usually same color as body, but may be flaxen.

REGII4.5 CHESTNUT: body color dark red or brownish-red; mane and tail usually dark red or brownish-red, but may be flaxen.

REGII4.6 DUN: body color yellowish or gold; mane and tail are black or brown; has dorsal stripe and usually zebra stripes on legs, and transverse stripe over withers.

REGII4.7 RED DUN: a form of dun with body color yellowish or flesh colored, mane and tail are red or reddish, flaxen, white or mixed; has red or reddish dorsal stripe and usually red or reddish zebra stripes on legs and transverse stripe over withers.

REGII4.8 GRULLO: body color smoky or mouse-colored (not a mixture of black and white hairs, but each hair mouse-colored); mane and tail black; usually has black dorsal stripe and black on lower legs.

REGII4.9 BUCKSKIN: body color yellowish or gold; mane and tail black; black on lower legs; typically buckskins do not have dorsal stripes.

REGII4.10 PALOMINO: body color a golden yellow; mane and tail white; typically palominos do not have dorsal stripes.

REGII4.11 GRAY: mixture of white with any other colored hairs; often born solid-colored or almost solid-colored and get lighter with age as more white hairs appear.

REG114.12 RED ROAN: more or less uniform mixture of white with red hairs on a large portion of the body, but usually darker on head and lower legs; can have red or flaxen mane and/or tail.

REG114.13 BLUE ROAN: more or less uniform mixture of white with black hairs over a large portion of the body, but usually darker on head and lower legs.

REG114.14 BAY ROAN: more or less uniform mixture of white with red hairs on a large portion of the body; darker on head, usually red but can have a few black hairs in mixture; black mane and tail and black on lower legs.

REG114.15 CREMELLO: light (or pink) skin over the body, white or cream-colored hair and blue eyes.

REG114.16 PERLINO: light (or pink) skin over the body, white or cream-colored hair and blue eyes. Mane, tail and lower legs slightly darker than body color.

REG114.17 WHITE: body color white; skin is pink; eyes are usually dark; small black spots may be found in the skin, but usually are not accompanied by colored hair. Some white horses may be variegated, meaning they have patches of colored hair, usually intermixed with white.

REG115. MARKINGS. Descriptions of markings:

REG115.1 SNIP: any white marking between the nostrils.

REG115.2 STAR: any marking on the forehead.

REG115.3 STRIP: a narrow marking extending vertically in the area between the forehead and the nostrils.

Picture This

Having the correct photos will expedite the registration process so you can get your papers sooner. When submitting photographs of your horse, please remember to:

- * Use a 35 mm camera or high-quality digital camera. Avoid instant cameras because the photos tend to overexpose or fade.
- * Take photos on a sunny day with the sun behind the photographer.
- * Always send four basic views - front, rear, left side and right side.
- * You should include a fifth photo - a 3/4 front view clearly showing the face and all four feet. If someone is helping you, make sure they are out of this photo.
- * Position the horse with his legs apart so all four feet can be seen in each of the photographs.
- * Do not saddle or blanket your horse and make sure the horse is clean of mud and debris.
- * The horse being photographed should be the only horse in the photo.
- * Take photos on level ground - steer clear of tall grass and other obstacles which can block the view of the horse.
- * Pull back the forelock so head markings can be seen.
- * Take separate, close-up photos of unusual markings and markings that fall out of the normal marking area.
- * Be aware of the background. A solid background is best for light colored horses, while a dark horse shows up best with a lighter background.

Contact our office for a brochure on how to photograph your horse.



CORONET

Any narrow marking around the coronet above the hoof.



HALF PASTERN

A marking that includes only half the pastern above the coronet.



PASTERN

A marking that includes the entire pastern.



SOCK

A marking that extends from the coronet halfway up the cannon bone, or halfway to the knee on the foreleg or halfway to the hock on the back leg.



STOCKING

A full marking to the area of the knee on the foreleg and to the area of the hock on the hind leg. It is an extended sock.



STAR

Any marking on the forehead.



SNIP

Any marking, usually vertical, between the nostrils.



STRIP

A narrow marking extending vertically in the area between the forehead and the nostrils.



STAR AND STRIP

A marking on the forehead with a strip to the nasal peak. The strip does not have to be an extension of the star.



BALD FACE

A very broad blaze. It can extend out and around the eyes and it can extend down to the upper lip and around the nostrils.



DISCONNECT-ED STAR, STRIP AND SNIP

A marking on the forehead with a narrow extension of the nasal peak and opening up again between the nostrils. These may be connected.



BLAZE

A broader vertical marking extending the length of the face, of a relatively uniform width.



STAR, STRIP AND SNIP

A marking on the forehead with a narrow extension of the nasal peak and opening up again between the nostrils. These may be connected.

REG115.4 BLAZE: a vertical marking of medium, uniform width extending the length of the face.

REG115.5 STAR AND STRIP: a marking on the forehead with a strip to the nasal peak. The strip does not have to be an extension of the star.

REG115.6 STAR, STRIP and SNIP: a marking on the forehead with a narrow extension of the nasal peak and opening up again between the nostrils. These may be connected.

REG115.7 BALD FACE: a very broad blaze. It can extend out and around the eyes and it can extend down to the upper lip and around the nostrils.

REG115.8 CORONET: any narrow marking around the coronet above the hoof.

REG115.9 HALF PASTER: a marking which includes only half the pastern above the coronet.

REG115.10 PASTER: a marking which includes the entire pastern.

REG115.11 SOCK: a marking which extends around the leg, from the coronet halfway up the cannon bone, or halfway to the knee on the foreleg or halfway to the hock on the back leg.

REG115.12 STOCKING: a full marking to the area of the knee on the foreleg and to the area of the hock on the hind leg. It is an extended sock.

REG115.13 ROAN PATCHES; PATCHES OF SCATTERED WHITE HAIR: areas with white hair scattered through the basic body color and which do not have underlying light-colored skin.

REG115.14 PATCHES OF DARKER-COLORED HAIR: concentrated areas in which the hair has a darker pigmentation than the surrounding hair of its basic body color.

REG115.15 DARK SPOTS: patches of dark hair (or basic body color) within white markings.

REG115.16 WHORL: hair growth that forms a spiral pattern.

REG116. RE-REGISTRATION CERTIFICATE. Re-registration certificates are issued to indicate a change in the sire, dam or foaling year.

REG116.1 A re-registration certificate requires a properly completed registration application, accompanied by a breeder's certificate, a stallion breeding report and a statement from the owner (or lessee or authorized agent for owner) of the dam at time of foaling, which gives details as to why the horse was incorrectly registered. In addition, if the foaling year is changed to an earlier year, the difference between the registration fee paid at that time and the amount which should have been paid at that time, must be remitted. AQHA must be provided with the original registration certificate before a re-registration certificate can be issued.

REG117. CORRECTION OF A REGISTRATION CERTIFICATE

REG117.1 The registration certificate shall accurately describe the horse for which it has been issued. An owner is responsible for immediately reporting any discrepancy on a registration certificate to AQHA and returning it for correction. The Executive Committee may cancel a registration certificate if preliminary examination indicates the certificate does not describe the horse for which it was issued.

REG117.2 A corrected certificate is issued to indicate a change in

color, markings, gender (male to female or vice versa) or foaling month; from gelding to stallion; removal of scars or brands which previously had been indicated on the certificate; or the correction of a date of transfer. AQHA must be provided with the original certificate before a corrected certificate can be issued.

REG117.3 A free correction on a registration certificate may be made through the 12th month following a horse's foaling date or six months from the date a registration certificate was issued, whichever is later.

REG117.4 Correction of an original registration certificate may be obtained by the current record owner or owner's authorized agent by filing the proper form completed in all respects, along with four full-view current photographs of the horse showing both sides, front and rear views.

REG117.5 When a significant correction in the description of a horse is requested, positive identification may be required if the ownership is no longer recorded in the name of the original owner (owner of dam at time of foaling). Such positive identification requires written affirmation and signature on a photograph of the horse (clearly showing distinctive markings) from the original owner or authorized agent stating that the photograph is of the horse in question.

REG117.6 If the application for a corrected certificate contains a discrepancy that raises a question as to the identity of the horse, an inspection may be required.

REG117.7 If a horse is still in the ownership of the party that first made application to register it, correction of a registration certificate that is a change of color only may be obtained by the record owner, by filing a written statement of the correct color. The registration certificate and correction fee must be returned with the signed statement.

REG117.8 To correct the date of transfer recorded with AQHA, AQHA must be provided with signed statements from both seller and buyer giving the correct date, the horse's registration certificate and the correction fee. At AQHA's discretion and in the interest of equity, the date of transfer may be corrected upon AQHA's receipt of a signed statement from either buyer or seller.

REG117.9 If a registration certificate is delivered to AQHA's office for a correction, but the correction items are not in proper order to issue a corrected certificate, the registration certificate will be retained by AQHA until the correction can be completed and a new certificate issued.

REG118. CHANGE OF HORSE'S NAME. A horse's name may be changed so long as it has not:

REG118.1 competed in an AQHA-approved show or special event;

REG118.2 started in a recognized race;

REG118.3 earned a special achievement recognition award as per SHW817;

REG118.4 earned any money or award with an AQHA affiliate as shown on AQHA records;

REG118.5 appeared on any breeding document submitted to AQHA.

REG119. REPLACEMENT CERTIFICATE. A replacement certificate is a new registration certificate issued when the original certificate is in existence but has been defaced. AQHA must be provided with the original certificate before a replacement certificate can

be issued.

REGI20. DUPLICATE CERTIFICATE. A duplicate registration certificate is issued when the original has been lost or destroyed and sufficient proof of loss and proper identification of the horse has been submitted to AQHA.

REGI20.1 AQHA may issue a duplicate registration certificate after the current record owner or authorized agent files the properly completed form and stating the circumstances under which the original registration certificate was lost or destroyed, and pays the required fee. Such form is to be accompanied by four full-view current photographs of the horse, showing both sides, front and rear views.

REGI20.2 If the owner is not AQHA's record owner, he additionally shall provide AQHA a statement from the last record owner to obtain the duplicate registration certificate. Such statement shall describe the circumstances of the transfer and the identity of the person to whom the registration certificate was delivered.

REGI20.3 If the certificate was lost by a trainer or racing official at the track, statements from such other persons should accompany the record owner's request for a duplicate certificate.

REGI20.4 If the application for the duplicate certificate contains a discrepancy to question the identity of the horse, AQHA may require inspection.

REGI20.5 To issue a duplicate certificate when the record owner or authorized agent cannot be located to complete a statement, after all reasonable efforts by the current owner and then by AQHA, the following items are required:

REGI20.5.1 properly completed and signed transfer reports or acceptable bills of sale reflecting each ownership change beginning with the record owner.

REGI20.5.2 statement signed by each party who had the original certificate in his or her possession after the record owner;

REGI20.5.3 a signed statement from current owner giving details of all attempts to contact record owner.

REGI20.5.4 four current full-view photographs of the horse, both sides, front and rear views.

REGI20.6 In regard to involuntary transfers, including, but not limited to, court judgment, stableman's lien or security interest foreclosure, when a previous owner is unavailable to verify the whereabouts of the original registration certificate or refuses to adhere to a court judgment by delivering the original registration certificate for transfer, at AQHA's discretion, and in the interest of equity, requirement of statement of the record owner may be waived and the current owner deemed eligible for a duplicate certificate.

REGI21. AGE OF A HORSE

REGI21.1 The age of a horse shall be computed on the basis of a calendar year starting January 1 of the year foaled. It is a weanling during the calendar year in which foaled and a yearling during the first calendar year following its foaling date, regardless of the time of year foaled. For example, a horse foaled anytime in 2011 was considered to be one year old on January 1, 2012, and two years old on January 1, 2013.

REGI21.2 A horse is not eligible to participate in AQHA-approved events if its age, as determined by examination of its teeth, does not

correspond to the age shown on its registration certificate. Such determination by tooth examination is to be made in accordance with the current guidelines of the American Association of Equine Practitioners.

REGI21.3 Every exhibitor, owner or trainer shall, upon request by AQHA, a show manager or racing steward, permit a tooth examination to be made by a representative of AQHA and/or a licensed veterinarian. Refusal to comply with such request shall constitute grounds for immediate disqualification of the horse from the AQHA event in progress or any other AQHA-approved event and shall constitute grounds for suspension of AQHA membership.

REGI21.4 Should such tooth examination show the horse's age to not correspond to the foaling date shown on its registration certificate, such examination shall constitute sufficient evidence that the horse's age as shown on its registration certificate is erroneous. The horse automatically shall be suspended from participating in the AQHA-approved event in progress and any future AQHA-approved events pending a hearing before the Executive Committee.

REGI21.4.1 The exhibitor, owner or trainer shall, upon request by AQHA, a show manager or racing steward, deliver the horse's registration certificate to the requesting party who immediately shall forward the certificate and statements from the person or persons making such examination and findings to AQHA Registration Department.

REGI21.4.2 At a time and place designated by the Executive Committee, a hearing will be held at which time the horse's record owner, and/or breeder, shall provide evidence to substantiate the foaling date shown on the registration certificate. In absence of substantial evidence to the contrary, the Executive Committee may cancel the horse's registration and take appropriate action against the person or persons involved.

REGI21.4.3 If the pedigree is substantiated but the age discrepancy remains unresolved, the Executive Committee may direct an appropriate notation be made on the certificate to allow the horse to be used for breeding purposes, but prohibiting its participation in approved events.

REGI22. GELDINGS - SPAYED MARES. When a horse is gelded or a mare is spayed, such fact should be reported to AQHA immediately.

REGI22.1 This should be done by providing AQHA the horse's registration certificate and a statement from the owner of record indicating the date the horse was gelded or spayed. At no charge, AQHA will make the appropriate notation in its records and on the registration certificate and return the certificate to the owner.

REGI22.2 The track identifier or racing secretary of a track under the supervision of a state-appointed racing body or the secretary of an AQHA-approved event may correct a registration certificate to reflect the fact of gelding by notation on the registration certificate in an indelible manner, along with the date such notation is made, initialing such notation. Additionally, such track or show official shall immediately inform AQHA of such correction to the certificate.

REGI23. SCARS AND BRANDS. All scars, brands and tattoos on a horse should be shown on its registration certificate.

REGI23.1 Brands, scars or identifying tattoos not appearing on the certificate will be added by AQHA free of charge if the record owner submits the registration certificate, a diagram showing the

shape and location of the scar or brands, and the date of injury or branding, if known; or the location and exact description.

REGI23.2 For white hairs appearing on the scar tissue, on an area of the horse previously covered by darker hairs, refer to REGI17.2 and REGI17.4.

REGI24. TRANSFER OF OWNERSHIP. Each transfer of ownership of a registered horse shall be recorded by AQHA.

REGI24.1 The responsible party as specified in REGI24.4 must submit all transfer items to AQHA immediately after purchase to ensure prompt service, to reduce the possibility of losing either certificate or transfer report and to lessen the chance of complications that might make it impossible to ever record the transfer.

REGI24.2 To record a transfer, the responsible party must supply AQHA the following items:

REGI24.2.1 the registration certificate of the horse;

REGI24.2.2 a properly completed and signed AQHA transfer report by the last recorded owner, as well as one from any subsequent owner(s) and;

REGI24.2.3 the required fee, with the membership status of the buyer determining the applicable transfer fee.

REGI24.3 AQHA will recognize the signature of any one of the joint owners of the horse on AQHA's transfer report if such owner is named on the horse's current registration certificate, except for a transfer by one joint owner (or agent) to him or herself, which transfer shall require the signature of one of the other joint owner(s)/agent(s). Additionally, AQHA will recognize the signature of any partner when a partnership is a record owner. If such recognition is not to be permitted, or is to be limited otherwise, the joint owners or partnership must file with AQHA a written agreement to that effect, specifying horse's name and registration number, and signed by all such joint owners or partners.

REGI24.4 Seller's Responsibility: The owner of record at time of sale has the responsibility for completing an AQHA transfer report in its entirety and for delivery of it to AQHA.

REGI24.4.1 The seller must provide on the transfer report the correct name and registration number of the horse, date of sale, name and address of buyer, and signature and address of seller. The seller shall deliver the transfer form, along with the registration certificate, to AQHA, along with any other documents required to complete the transfer of ownership. Payment of the required fee shall be a matter of private negotiation between the buyer and seller and may be paid by either of them, but such fee must accompany the transfer, with the membership status of the buyer determining the applicable transfer fee.

REGI24.4.2 Auction Sale: For a horse sold through an auction, the seller may rely on the auction management to send the registration certificate, properly completed transfer report and required transfer fee to AQHA on the seller's behalf. Ultimate responsibility for completion and delivery of the transfer report along with any other documents required to complete the transfer of ownership to the current owner, to AQHA, continues however to remain with the seller.

REGI24.5 Any alteration or defacement, change or amendment of a transfer report may necessitate verification.

REGI24.6 When a horse is claimed at a recognized race track,

the racing secretary shall collect a transfer fee and membership fee, if necessary, from the claimant which shall be forwarded to AQHA, together with the registration certificate, a written report of the race showing the date of the race, and the name and address of the person claiming the horse. Upon receipt of such fee(s), certificate and report, AQHA will complete the transfer without the report being signed by the record owner. If the notice of claim and the supporting documents are received by AQHA within 14 days of the claim, the transfer will receive free special handling rush service.

REGI24.7 If a registration certificate and transfer report are delivered to AQHA without sufficient information, the registration certificate will be retained by AQHA until the transfer can be completed and recorded.

REGI25. LEASES

REGI25.1 For a lease of a horse to be recognized, written notice of such lease must be filed with AQHA, signed by both the recorded owner as lessor, and the lessee. The notice shall specify the effective date of lease and may not exceed three years. At the expiration of a three year lease term, the lease must be re-recorded to remain effective. If the lease term is for a shorter period, it shall also provide a termination date. To terminate a lease other than expiration of the lease term, provide written notice to AQHA specifying the termination date, signed by both lessor and lessee, or by a properly executed transfer report which shows a change of ownership from lessor to lessee, signed by the record owner/lessor. No fee is charged for terminating a lease, whether automatic or by subsequent notice.

REGI25.2 Enforcement of the lessee's limitation on use of the horse is solely the responsibility of the lessor.

REGI25.3 Transfers of horse ownership from recognized claiming races terminate a lease.

REGI25.4 During the term of the lease, AQHA will not record subsequent changes in ownership until the lease is terminated. Only the lessee or lessee's authorized agent is authorized to sign a breeder's certificate, stallion breeding report or registration application pertaining to the leased horses.

REGI26. AUTHORIZATIONS

REGI26.1 When a horse is owned by a company, ranch, farm, syndicate, corporation, partnership, university or school, club or family, AQHA must have an authorization form on file to indicate who may sign documents for that entity. Written authorization is also required when an individual owner appoints another individual to sign in his or her behalf.

REGI26.2 On all AQHA documents, except transfers as limited in rule REGI24.3, AQHA shall recognize the signature of any one of the joint owners of a horse if such owner is named on the horse's current registration certificate. Additionally, AQHA shall recognize the signature of any individual partner when that person is shown as an individual in the partnership name.

REGI26.3 In the case of a child younger than 18 years of age, AQHA requires a statement from the legal guardian or parent giving the birth date of the child and designating the person(s) signing on behalf of the minor.

REGI26.4 When the owner of a horse is deceased, AQHA must have legal documentation on file appointing the agent or representative for the estate (letters testamentary, letters of administration,

etc.) and bearing the original certification or seal of the clerk of the probate court. In the event there was no formal probate of the estate, a statement of heirship must be completed by the heirs and notarized.

REGI26.5 Authorization of agent may be cancelled by written notification signed by record owner or record lessee. Such termination of authorization will take effect on the date received at AQHA.

REGI26.6 When an authorization is granted by a lessee, that authorization will remain in effect until the date the cancellation of the authorization or termination of lease is received in AQHA's office.

REGI27. DEATH OF A HORSE AND HORSES SOLD WITHOUT PAPERS

REGI27.1 When any registered horse dies or is disposed of without papers, the owner must notify AQHA and surrender the registration certificate to AQHA for such notation. The registration certificate will be changed to note the horse's death and returned to the owner, unless AQHA is otherwise directed.

REGI27.2 When AQHA records indicate a horse has lived 25 years past January 1 of its foaling year, it will be automatically presumed to no longer be alive and automatically removed from the inventory of living horses. Offspring conceived after that date are ineligible for registration and the horse may not participate in AQHA-approved events until the owner verifies the horse is still living. Verification may require full-view color photographs and a written statement which the owner may be requested to provide on an annual basis.

REGISTRATION APPLICATION

Most Often Mistakes

Although many things are required to register a foal with AQHA, it is not typically the complicated rules that cause a delay. It is very basic information about the new foal. There are 14 numbered steps on the application—from naming the foal to providing its white markings; some of the most often missed things on an application are noted on Page 75.

TRANSFER OF OWNERSHIP

Most Often Mistakes

Transferring the ownership of a horse is not typically a complicated process, and some of the most often missed things for a transfer are highlighted on Page 76.

FILL IN ALL THAT APPLY

- Special handling fee for 3-4 day service is enclosed. This \$48 fee is in addition to the normal registration fee and does not provide overnight delivery service. If the box is checked, please make note on the outside of your envelope: RUSH REGISTRATION.
OVERNIGHT MAIL service of \$25 is included. This service is available for those who have requested special handling above. This fee is only applicable for service within the United States and does not include Saturday delivery charges. For those interested in service outside the United States and/or Saturday services, please contact our office at (800) 376-4811 for the correct fee.

1 GIVE FOUR NAME CHOICES NOT TO EXCEED 20 CHARACTERS AND SPACES. DO NOT USE PUNCTUATION MARKS.

Grid for entering four name choices, each with a numbered circle (1, 2, 3, 4) at the end of the row.

DO NOT WANT AQHA TO NAME THIS FOAL. UNLESS THIS BOX IS CHECKED, AQHA WILL SELECT A NAME IF YOUR NAME CHOICES ARE IN USE OR NOT ACCEPTABLE.

2 COLOR (FILL IN ONE)

- Bay, Bay Roan, Black, Blue Roan, Brown, Buckskin, Chestnut, Cremello, Dun, Grey, Gulo, Palomino, Perlino, Red Dun, Red Roan, Saddle, White

3 GENDER

- Stallion, Mare, Gelding

FOR A LOWER FEE REGISTER YOUR FOAL ONLINE AT www.aqhamembers.com

4 DATE FOALED

Grids for entering Birth, Day, and Year.

5 STATE/COUNTRY FOALED

Grids for entering State Foaled and Country Foaled (if not in U.S.).

SIRE

SIRE ONLINE AT TIME OF BREEDING

DAM

DAM ONLINE AT TIME OF BREEDING

An official veterinarian or authorized agent of said owner of the dam at the time this foal was foaled, or at the time of breeding if embryo transfer, I hereby certify that all information on this registration application is true and correct to the best of my knowledge, and agree that AQHA may have the privilege to correct and/or cancel the registration certificate for cause under its rules and regulations. If on the owner of dam at time of breeding and foaling and consents, sign box 7 and/or 8 (owner's certificate), but NOT sign box 1. Understand that my signature on the breeder's certificate may be used to satisfy the signature requirements for box 1. Subscribing the document to AQHA, I hereby agree to be bound to all the terms and conditions of AQHA's Official Handbook of Rules and Regulations.

6 SIGN HERE

BY SIGNING

Signature line for owner or authorized agent.

WRITTEN SIGNATURE OF OWNER/OWNER OR AUTHORIZED AGENT OF SIRE WHEN FOAL WAS BORN, OR BY OWNER OF DAM AT TIME OF BREEDING IF BY EMBRYO TRANSFER.

Daytime telephone number including area code.

E-MAIL ADDRESS

BREEDER'S CERTIFICATE SECTION - Any erasure or alteration in this section will necessitate verification.

7 SIGN HERE: Signature of sire at time of breeding. 8 SIGN HERE: Signature of dam at time of breeding. Includes name and AQHA ID fields.

9 FILL IN ALL THAT APPLY

\$48 DNA TESTING FEE REQUIRED FOR PARENTAGE VERIFICATION

- Foal produced by embryo transfer. Date embryo transferred / / Number of embryos transferred.
Foal produced by frozen embryos. Date of implantation / /
Foal conceived by cooled/transported semen.
Foal conceived by using frozen semen.
Other.
\$40 HYPP TEST. \$85 DISEASE PANEL TEST FOR HYPP, GGED, WH, PSSM1 and HERDA. \$105 DISEASE PANEL AND DNA TEST

10 MEMBERSHIP AND REGISTRATION FEES

Table with columns: Registration Fees, Member, Non-Member. Rows show fees for different foaling dates (7 months to 48 months after foaling date).

Payment section including checkboxes for Check, Money Order, or Credit Card (AMERICAN EXPRESS, MASTERCARD, VISA). Includes fields for card number, expiration date, and cardholder name. Also includes fields for cardholder signature and zip code.

AQHA MEMBERSHIP FEES table. Rows for 12-month (\$40), 3-year (\$85), and Life (\$750) memberships. Includes text: 'Membership may be purchased at time of transaction to receive immediate member-only pricing.'

JOURNAL logo and subscription information. Text: 'DO NOT SEND CASH - U.S. FUNDS ONLY'. Includes contact info for the American Quarter Horse Journal.

Transfer Report

FOR OVERNIGHT DELIVERY TO AQHA: 1600 QUARTER HORSE DR, AMARILLO, TX 79104 • MAILING ADDRESS: P.O. BOX 200, AMARILLO, TX 79108
WWW.AQHA.COM • ☎ (806) 376-4811 • FAX (806) 345-6400 • telex (806) 373-2281

INSTRUCTIONS:

1. Print or type all requested information.
2. The color and markings of the horse should be verified with the Certificate of Registration.
3. Any erasure or alteration on this report may necessitate verification.
4. The Certificate of Registration should list the owner as the person selling the horse.
5. Consult the AQHA Official Handbook regarding transfer rules or contact AQHA.
6. Remit appropriate fees, the transfer report and the Certificate of Registration to AQHA.

We certify that the horse sold is the horse registered with the American Quarter Horse Association as described on the Certificate of Registration delivered to AQHA in conjunction with this transfer report. We authorize AQHA to record the transfer of ownership of the horse upon AQHA's receipt of all required transfer items.

As the seller, I want to enroll this horse in the AQHA Full Circle program and, if able, will help provide options to future owners in the event this horse becomes unwanted or is ready for retirement. No cost, visit aqha.com to learn more.

GELDED:
 YES (DATE (IF KNOWN, MMDDYYYY))

HORSE'S NAME: AQHA REGISTRATION NUMBER:

If this transfer is for an unregistered foal, indicate foal's birthdate and name and registration number of sire and dam.

BIRTHDATE (MMDDYYYY) SIRE AQHA REGISTRATION NUMBER DAM AQHA REGISTRATION NUMBER

DATE OF SALE:
DATE POSSESSION OF HORSE ACTUALLY CHANGED (MMDDYYYY) BUYER'S AQHA ID #

SOLD TO: BUYER'S NAME

FILL IN THIS CIRCLE IF THIS IS A NEW ADDRESS BUYER'S ADDRESS

CITY STATE/PROVINCE POSTAL CODE

DAYTIME TELEPHONE E-MAIL

SIGNATURE OF SELLER SELLER'S AQHA ID #

FILL IN THIS CIRCLE IF THIS IS A NEW ADDRESS SELLER'S PRINTED NAME

SELLER'S ADDRESS (STREET OR BOX NUMBER)

CITY STATE/PROVINCE POSTAL CODE

AREA CODE DAYTIME PHONE E-MAIL ADDRESS

REQUIRED: If consigned to auction sale, please give name, date and mailing address of sale company.

COMPANY NAME MAILING ADDRESS DATE OF AUCTION

FEES — SUBJECT TO CHANGE WITHOUT NOTICE

- Transfer fee for current AQHA or AQHYA Member \$20
- Transfer fee for nonmember who wishes to become a 12-month AQHYA Member \$60
- Say Goodbye to Renewal Notices — Have your membership and/or Journal subscription automatically renewed on the credit card you've provided. Nothing will lapse if you elect to auto renew — plus we'll hold your annual membership renewal dues at \$35 for three years. You can cancel at any time.
- If you do not wish to enroll in the auto renewal program, fill in the circle here:
- Transfer fee for nonmember who wishes to become a 12-month AQHYA (Youth) Member \$35
- Birthdate of youth
- OPTIONAL — Special Handling - two-day service (in addition to regular fee). If you select special handling, please make note on the outside of your envelope, "Rush Transfer" \$25
- OPTIONAL - Overnight Service is available to those who requested special handling above. This fee is only applicable for service within the United States and does not include Saturday delivery charges. For service outside the U.S. and/or Saturday service, contact our office for current rates \$20

Dues payments may be deductible by members as an ordinary and necessary business expense; however, contributions or gifts to the American Quarter Horse Association are not deductible as charitable contributions for federal income tax purposes. However, donations to the American Quarter Horse Foundation ARE tax deductible to the extent allowed by law. \$1 of your annual membership dues is designated for a subscription to America's Horse, AQHA's official member publication.

Through the payment of a membership fee to AQHA, I acknowledge that membership in AQHA is voluntary and I agree to be bound by all the terms and conditions of AQHA's Official Handbook of Rules and Regulations.

AQHA OFFICIAL PUBLICATION SUBSCRIPTION				
SUBSCRIPTIONS RATES		U.S.	CANADA	INTERNATIONAL
JOURNAL	1-year	\$ 25	\$ 50	\$ 80
	3-year	\$ 60	\$ 135	\$ 225

For information about AQHA Publications visit aqha.com/magazines

CHECK MONEY ORDER IF PAYING BY CREDIT CARD, PLEASE COMPLETE THE FOLLOWING:

AMERICAN EXPRESS MASTERCARD VISA

CARD NUMBER

EXP. DATE (MM/YY) DAYTIME PHONE

CARDHOLDER NAME

CARDHOLDER SIGNATURE BILLING ZIP CODE

DO NOT SEND CASH - U.S. FUNDS ONLY

11114 - TRANS14-744

SHW100. AQHA SHOW APPROVAL is a privilege, not a right, granted or rejected at AQHA's discretion on an annual basis according to continuous evaluation of the applicant, including, but not limited to competence of show management, enforcement of AQHA rules, quality of show, and service to AQHA members.

SHW100.1 AQHA reserves the right to approve only the number of shows per calendar year it deems appropriate for the same organization or management.

SHW100.2 An "AQHA-approved event" means an official class of competition or show with results that are accepted by AQHA in its records as official.

SHW100.3 AQHA will issue a statement of official approval of the proposed special event or show, or notify the organization or individual making the application of reasons for not approving a show or special event.

SHW100.4 Lack of approval of any certain class in a proposed show need not invalidate the recognition of the remainder of the show.

SHW100.5 All approved classes must be open to any American Quarter Horse owner meeting age, ownership and eligibility requirements. Membership in AQHA and/or AQHYA for youth competition is the only mandatory membership.

SHW100.6 To compete in an AQHA-approved class, a horse must be entered in the class with show management prior to the start of the class.

SHW100.7 The exhibitor must accurately complete entry forms and assumes responsibility for any errors.

SHW100.8 A horse entered in the wrong class may be transferred to its correct class after the judging program has been printed.

SHW100.9 Any contestant withdrawing from a show after entering shall forfeit any fees and all go-round money which may be credited to him at the time of his withdrawal; except that in case of incapacitating sickness or injury to himself or his horse, or serious illness or death in the contestant's family, all prize monies won by him to that point shall be paid.

SHW100.10 Any AQHA-approved show which fails to pay for services rendered by third parties in connection with the holding of the approved shows (i.e. judges' fees, cattle charges, facilities, insurance or drug testing fees, etc.) or pay premium monies to exhibitors can be denied AQHA approval for present and future shows. The show manager and/or show secretary and sponsoring organization and/or its representatives can be denied privileges of AQHA and suspended from membership.

SHW100.11 Barrels shall not be used as markers in any event except barrel racing.

SHW100.12 Chairs shall not be used as markers in any events.

SHW100.13 In speed events, it is recommended that drags be conducted before the start and after every seven head; show management may drag more frequently.

SHW100.14 One of the individuals designated on the show approval application as show manager or show secretary for AQHA-approved shows and special events must have attended an AQHA show management seminar within five years preceding the date of the scheduled show.

SHW100.15 Alliance approved managers and secretaries are not

required to attend a show management seminar in order to hold an AQHA alliance event.

SHW100.16 Show management delinquent and/or habitual in submitting (1) show approval requests, (2) results, (3) incomplete information or (4) failing to submit electronic results will be reviewed by the AQHA Show Council.

SHW100.17 Show management is not allowed to add to the total number of approved shows.

SHW101. NEW/FIRST-TIME SHOW/SPECIAL EVENT

which was not approved or held the prior year is considered a new show.

SHW101.1 A letter of request for a new show must be directed to AQHA's Competition Department and accompanied by a \$25 non-refundable processing fee.

SHW101.2 Applicants desiring to hold an AQHA-approved show must obtain prior AQHA approval.

SHW101.3 No new show, including a special event, will be approved if there already exists another show or special event on the same day, within each region's specific mileage calculated by MapQuest's shortest driving distance:

450 miles – Region 1

400 miles – Region 2

350 miles – Regions 3 and 9

200 miles – Regions 4, 5, 6

500 miles – Region 7, 8 and 10

SHW102. APPROVAL FOR A PREVIOUSLY HELD SHOW with priority dates

does not carry over from year to year and must annually be obtained for each individual show.

SHW102.1 To obtain approval for a previously held show with priority dates, a show application for approval must be (1) properly completed in its entirety, (2) accompanied by the non-refundable application for approval fee, (3) submitted and received at least 120 days prior to the first date of the proposed show in order to be published in two issues of *The American Quarter Horse Journal*, and (4) accompanied by a list of all classes, whether or not all of the classes are limited to AQHA-registered horses and a proposed schedule of classes.

SHW103. PRIORITY DATES FOR PREVIOUSLY HELD SHOWS.

An AQHA-approved show, including a **Level I** show sanctioned by the affiliate, having been held the previous year is considered an established show and has priority to reserve identical days per calendar week for the current year until terminated by AQHA. This reservation is called a priority date.

SHW103.1 Shows held on a US federal holiday will retain their priority date for that particular holiday: New Year's Day; Martin Luther King Day, Presidents Day, Memorial Day, Independence Day, Labor Day, Columbus Day, Veterans Day, Thanksgiving Day, and Christmas Day.

SHW103.2 Shows which move onto a holiday, due to the normal calendar roll, resulting in conflict with an existing holiday show, will be required to move dates.

SHW103.3 Priority dates are a privilege, not a right, and therefore cannot be sold or transferred from one sponsoring body or management to another without full disclosure to AQHA. Violation of this rule could result in disciplinary action.

SHWI03.4 Special events, introductory shows, Versatility Ranch Horse shows and Equestrians with Disability shows do NOT retain priority dates from year to year.

SHWI03.5 A show will not retain priority dates in subsequent years if it cancels for reasons other than:

SHWI03.5.1 acts of God (fire, flood, blizzard, tornado, hurricane, etc.);

SHWI03.5.2 facility conflict (with written verification from facility);

SHWI03.5.3 loss of facility beyond show management's control (with written verification from facility);

SHWI03.5.4 conflict with AQHA regional events.

SHWI03.5.5 outbreak of equine disease or infection.

SHWI03.6 A show that changes sponsoring body (the individual or group financially responsible for holding the show), changes location more than 150 miles, or moves to another state is considered a new show without priority dates.

SHWI04. SHOW APPLICATION FOR APPROVAL FEES

based on total number of entries from the previous year's event:

\$1,500 = 5,000 or more entries

\$1,000 = 2,500-4,999 entries

\$750 = 1,000-2,499 entries

\$500 = Events with 500-999 entries

\$250 = Events with 250-499 entries

\$150 = Events with 249 and fewer entries

\$150 = Introductory Show/Level I Shows/Rookie Shows

Ranch Horse/New Special Event or New Show

\$50 = Dressage/EWD

SHWI05. SHOW APPLICATION FOR APPROVAL LATE FEES determined by date received in AQHA's office:

SHWI05.1 Show/Special Event

\$200 - 90-119 days prior to show date

\$400 - 60-89 days prior to show date

\$1,000 - less than 59 days prior to show date and subject to denial

SHWI06. Changes in a show application, after filing, may be made after the 120-day deadline specified above, provided AQHA is able to publish changes in one issue of *The American Quarter Horse Journal* prior to the approved date.

SHWI07. DATE AND/OR LOCATION CHANGE REQUESTS must be submitted in writing and accompanied by a

\$25 non-refundable fee.

SHWI08. TYPES OF SHOWS:

Livestock Shows and Fairs. Some of the largest AQHA approved shows are held during livestock shows and fairs. These collective events, which feature shows for other livestock, offer all levels of competition including youth classes. The number of entries may be high, and you can find seasoned and casual exhibitors.

SHWI08.1 Double Judged/Double Point (DJ/DP*).** This format features one show with two judges judging independently of one another which means top placings could earn two sets of points without having to exhibit twice. Double judged/double point shows are primarily found at major livestock shows where there are a large number of exhibitors. The majority of exhibitors who attend these shows are highly competitive, so expect top-quality exhibitors and American Quarter Horses. Expect to pay two entry fees as each of

the two judges' placings will result in separate results and therefore, two full sets of AQHA points.

SHW108.1.1 All major livestock shows and state fairs that meet eligibility requirements will be allowed one double judged-double pointed AQHA-approved show per year.

SHW108.1.2 In multiple judged shows in the timed events only, one judge may oversee/judge the class(es) and sign both set of judge's cards.

SHW108.1.3 If show management wishes to return to original format after having utilized the DJ/DP the following year format they may do so.

SHW108.1.4 A maximum of two existing affiliate-designated approved shows and existing state shows/fairs operating under the double-judge format may have the option of changing to a three or four judged format provided it does not increase the number of shows in that circuit.

SHW108.2 Split/Combined (S/C**)** Any two consecutive shows (like a Saturday and Sunday show) can be combined into one show and split over two days. There are two judges and two sets of points but the class is held only once. Expect to pay two entry fees.

SHW108.2.1 Existing split/combined shows have the option of modifying their schedule to allow a four-day show to be held in two days or a two-day show to be held in one day by holding two shows simultaneously.

SHW108.2.2 Any two consecutive shows may be allowed to combine to be one show with classes split over a maximum of two consecutive days with two judges and two sets of points with classes only held once. Maximum combination of shows in one day will be up to four shows; no more than four judges are allowed to judge in the ring at one time.

SHW108.2.3 Show management has the ability to select classes to be held each day under each judge separately and allow other classes to be held in a split combined format under both judges at the same time.

SHW108.3. Special Events (SpEv**)** As the name implies, special events may feature two single events like team penning and ranch sorting, barrel racing and pole bending or roping events like team roping and tie-down roping. Both serious and casual competitors attend special events. A single set of points is awarded at each special event. A maximum of two class types will be allowed per event. AQHA state/provincial affiliates may request two special events by category, per state province.

SWW108.3.1 Organizations or individuals wishing to stage or sponsor special events must obtain AQHA approval for results to be recognized and points to be awarded to the horses that place sufficiently high in that event.

SHW108.3.2 All rules and regulations pertaining to AQHA-approved shows will be followed.

SHW108.3.3 allow two existing special events per year per state may apply to be double judged and must have affiliate approval. Special events must be in good standing, for three consecutive years. Additional shows or points cannot be added to existing events.

SHW108.3.4 AQHA state/provincial affiliates may request two special events by category, per state/province.

SHWI08.4 Level I Shows/Rookie shows hosted by or approved by AQHA state and provincial affiliates and are usually held as stand-alone events but can be held during an open (non-AQHA-approved) show. A minimum of six Level I youth and six Level I amateur classes are recommended. An instructional clinic/seminar should be held in conjunction with the show and presented by an AQHA Professional Horseman. The show judge may not serve as a clinician except in international countries. Level I shows may be held over two days and only one set of points are awarded.

SHWI08.5 Alliance Shows (AL EV**)** AQHA points can be earned by competing at shows hosted by AQHA alliance partners such as National Cutting Horse Association, National Reining Horse Association, National Reined Cow Horse Association, National Snaffle Bit Association, Cowboy Mounted Shooting, etc. Approved events award points based on the AQHA system to those exhibitors who enjoy showing in both associations. Exhibitors must meet AQHA ownership and eligibility requirements. A complete list of alliance partners can be found at aqha.com.

SHWI08.6 Ranch Horse Competition (RH**)** demonstrates the versatility of the working ranch horse in four categories – ranch riding, ranch trail, ranch reining, ranch cutting, ranch cow and ranch conformation. Points will be awarded in each individual class according to the placing received and based on the number of horses competing in the particular class. Points will also be awarded to the All-Around winners who compete in classes based on their cumulative credits from the individual classes. To be eligible one rider/one horse must compete in a minimum of one cattle class, one other riding event other than a cattle class, and ranch conformation for points in the All-Around VRH competition. Year-end awards will be based on the number of points received in the All-Around placing. The Versatility Ranch Horse competition promotes the athletic ability and versatility of the horse.

SHWI08.7 AQHA Equestrians with Disabilities This competition is open to people with physical or cognitive disabilities that love competing with American Quarter Horses. Classes can be held at AQHA-approved shows and events, US para-equestrian events or can be stand-alone events. In order to participate in EWD events, an AQHA diagnosis form and AQHA acceptable adaptive equipment form must be completed. A valid AQHA membership number or membership application must be submitted to AQHA. Upon receipt of the forms, an AQHA membership card will be issued with EWD notation.

SHWI08.8 Dressage is a French term meaning “training” and its purpose is to develop the horse’s natural athletic ability and willingness to work making him calm, supple and attentive to his rider. Dressage patterns, or “tests,” are designed to showcase the horse’s ability to demonstrate these strengths through various movements. Competition occurs in a regulation size arena with specific apparel and equipment all regulated by USEF. AQHA-approved dressage classes will only be held concurrent with USEF/USDF-licensed shows which must be AQHA approved. Open, amateur and youth eligibility are based on AQHA criteria.

SHWI08.10 INTRODUCTORY SHOWS To increase and enhance new exhibitors’ participation and the AQHA show experience, AQHA, in its sole discretion, may waive and/or relax certain

AQHA show rules for introductory shows which include AQHA classes in their already scheduled open, all-breed or 4-H shows. Introductory shows do not retain priority date status.

SHWI08.10.1 Rules which may be relaxed for introductory shows include: date and proximity conflicts with other shows; qualifications and obligations of show officials, or judges application rules for specialized Level I judges.

SHWI08.10.2 Introductory shows shall be allowed to include limited exhibitor eligibility classes for the youth, amateur and open divisions.

SHWI08.10.3 Unless expressly waived or relaxed by AQHA, introductory shows will adhere to all show rules and can only be single judged.

SHWI08.10.4 AQHA reserves the right to require six core classes: western pleasure, showmanship, western horsemanship, hunter under saddle, hunt seat equitation and trail.

SHWI08.10.5 Introductory shows that exceed a 12-hour competition limit may be fined.

SHWI08.10.6 Incentive Fund is not to be paid on points earned at introductory shows.

SHWI08.10.7 Points earned at introductory shows do not count toward World Show qualification or incentive fund payout.

SHWI08.10.8 an exhibitor who has placed in the top 10 in a class at an AQHA World Show is not eligible to compete at an introductory show in that particular class.

SHWI08.10.9 Introductory shows count toward qualifying for the Level I championship show.

SHWI09. SCHEDULES. Show management has the option of holding some classes the afternoon or evening before their approved show date(s) provided that afternoon or evening not conflict with another existing approved event. For example, at a weekend show, the Saturday show may begin the preceding Friday afternoon and the Sunday show may begin on Saturday afternoon after all Saturday classes are completed.

SHWI09.1 Facilities with two or more arenas may begin:

SHWI09.1.1 speed events, team penning or ranch sorting even if the current day's show is still in progress any time after 4 p.m.

SHWI09.1.2 the next day's classes anytime in the afternoon or evening only if the speed events, team penning or ranch sorting of the current day's show are still in progress

SHWI09.1.3 one show before the other is finished with prior permission from AQHA

SHWI10. JUDGES must be chosen from AQHA's approved list.

SHWI10.1 If a judge is unable to fulfill a judging commitment, the acceptance of a substitute will be at AQHA's option.

SHWI10.2 A show is required to state the name of the judge for the show in at least one issue of *The American Quarter Horse Journal* prior to the scheduled show date. It is also strongly urged to provide the name of the judge on both the entry blank and catalog or premium list.

SHWI10.3 It is strongly recommended that the judge work no more than 10 hours in one day. If the hours spent judging are expected to run to an excessive length, show management should

consider hiring additional judges.

SHW112. CLASSES. In scored classes which are leveled, the Level 2 and Level 3 classes must run concurrently. Show management continues to have the option of running any placed classes separately which are leveled. Show management also has the option of running the rookie and Level 1 classes concurrent or separate.

SHW112.1 For classes run concurrently or separately, the points available to the Level 2 class will be based on the number of Level 2 entries in the class.

SHW112.2 The number of points available to the Level 3 entries will be the total number of both Level 2 and Level 3 entries in the class.

SHW112.3 Approval may be obtained to hold junior and senior classes when applicable, except western pleasure, reining and working cow horse events which may be divided into three classes.

SHW112.4 No 2-year-old may be shown in any performance class prior to July 1 of its 2-year-old year, except in showmanship at halter.

SHW112.5 Jumping, team penning and ranch sorting are all-age classes only.

SHW112.6 Only junior horses 5 years old and younger may be exhibited in junior classes.

SHW112.7 Only senior horses 6 years old and older may be exhibited in senior classes.

SHW112.8 Junior and senior classes, junior and hackamore/snaffle bit classes or all three classes (senior, junior and snaffle bit/hackamore) may be combined only when there are two or less entries in one or both divisions, or all-age classes split at the direction of the judge and the show management with the unanimous consent of all exhibitors involved in the class (or classes) in question. If a show wishes to combine a junior and senior bit reining class and has a hackamore/snaffle bit reining class, the hackamore/snaffle bit class still will be recognized as an approved class. Entries will be accepted after a class is combined. If classes are combined and additional entries are accepted such that there are now three or more entries in both open classes or youth divisions, classes must be split back the way they were originally offered.

SHW112.9 In all performance classes where each entry performs individually, the order of competition shall be determined by show management drawing lots. Horses entered in any class must be assembled in ample time for judging to start on time and continue without delay. They must remain in readiness until dismissed by the judge. A tardy contestant may be denied competition.

SHW112.10 In all performance classes, horses are to be ridden astride, except in pleasure driving where they will be driven, and in showmanship where they are led with a halter.

SHW112.11 It is mandatory that shows with multiple judges and arenas that offer the option of work at will for trail, western riding and working hunter must group like exhibitors together. Working orders for each group may be worked in a random order. For example, if the caliber of exhibitors and/or horses for Level 1 and I3 and under is similar, they would be worked as one group. Then, if the caliber of exhibitors and/or horses for Select, Junior and I4 to I8 are similar, they would be worked in a different group and could compete on a more difficult course. The same pattern must be used within each group.

SHW12.12 It is mandatory all patterns and courses be posted at least one hour prior to the class commencing.

SHW12.13 The score in the eliminations or go-rounds, and the score of each horse in the finals, or the score in the finals only will determine the final placings; consistency of performance to be recognized as a major factor.

SHW12.14 Any show that does not offer the required halter/performance halter classes in the open division will not have its results recognized.

SHW12.15 AQHA strongly recommends show management provide a youth division for exhibitors 18 years of age and under and an amateur division for eligible exhibitors.

SHW13. Specific Class Procedures for Leveled Classes:

SHW13.1 INDIVIDUALLY WORKED CLASSES WITH SUBSEQUENT RAIL WORK – Western Horsemanship, Hunt Seat Equitation, Hunter Hack

SHW13.1.1 All exhibitors will participate in the pattern portion.

SHW13.1.2 The class will be placed and the judge's top exhibitors will be called back for rail work. Judge will place a maximum of 15 exhibitors

SHW13.1.3 Level 2 entries not initially called back for rail work will stand by to see if separate Level 2 rail work is necessary.

SHW13.1.4 Providing enough Level 2 entries are included among the judge's top placings to award all available Level 2 points, no further rail work is needed.

SHW13.1.5 Should the number of Level 2 entries in the judge's initial top placings be insufficient to award all available Level 2 points, the remaining Level 2 entries will be called back for rail work and the judge will allocate the remaining available points for the Level 2 class.

SHW13.1.6 If a Level 2 finals is necessary to distribute all points, at the judge's discretion, exhibitors may be required to only work one way of the arena.

SHW13.2 INDIVIDUAL WORKED CLASSES - Western Riding, Trail, Working Cow, Cutting, Roping, Reining, Working Hunter, Equitation over Fences, Jumping, Showmanship - At show management's discretion, working orders may be in sequence or in blocks and classes will run concurrently. The class will be placed to distribute all available Level 3 and Level 2 points.

SHW13.3 RAIL CLASSES SHOWN AS A GROUP - Western Pleasure, Hunter Under Saddle, Pleasure Driving

SHW13.3.1 All exhibitors will participate on the rail, following which the class will be placed. Judge will place a maximum of 15 exhibitors

SHW13.3.2 Providing enough Level 2 entries are included among the judge's top placings to award all available Level 2 points, no further rail work is needed.

SHW13.3.3 Should the number of Level 2 entries in the judges initial top placings be insufficient to award all available Level 2 points, the remaining Level 2 entries will be called back for rail work and the judges will allocate the remaining available points for the Level 2 class.

SHW13.3.4 If a Level 2 finals is necessary to distribute all

points, at the judge's discretion, exhibitors may be required to work only one way of the arena.

SHW113.4 HALTER When a halter class is leveled there are two judging options:

SHW113.4.1 Option #1. The judge will place a maximum of 15 exhibitors both Level 2 and Level 3 and line up placings head to tail, in front of the judge, in the order placed.

SHW113.4.2 The Level 2 entries will then form a separate line to reflect the Level 2 placings for the judge.

SHW113.4.3 Option #2. The judge places a maximum of 15 entries on the Level 3 judges' card. The Level 2 entries are circled on the Level 3 judges' card. Those entries are transferred to the Level 2 judges' card.

SHW113.5 When a class is leveled, the announcer should begin by announcing the Rookie and then the Level I placing's or the Level 2 and then the Level 3 placing's

SHW114. LEVEL I CLASSES There is no limit to the number of Level I classes that may be offered; however, showmanship at halter, western horsemanship and hunt seat equitation are strongly recommended for most shows.

SHW114.1 If Level I classes are applied for, then the corresponding AQHA amateur or youth classes must also be offered.

SHW114.2 The Level I youth or Level I amateur class must be held prior to the corresponding amateur or youth class if the same judge is judging the Level I and corresponding class, with the exception of pattern classes at show management's option.

SHW114.3 All-age Level I youth classes may be held or Level I youth classes may be split into age groups. These must be applied for and held as 13 and under and 14-18. All age Level I amateur classes may be held or Level I amateur classes may be split into age groups. Must be applied for and held as Level I amateur and select Level I amateur classes.

SHW114.4 Level I halter may be offered as an approved and pointed class at any AQHA-approved show.

SHW114.5 Stallions may not be exhibited in any youth classes regardless of level. The only exception is for youth ages 14 and older residing in Mexico, South and Central America who may exhibit stallions in youth performance classes if such classes are held in Mexico, South and/or Central America. Additionally, stallions may not be shown in Rookie or Level I amateur classes.

SHW114.6 Level I halter class winners are only eligible for Grand and Reserve Champion at Level I shows.

SHW116. OPEN DIVISION APPROVAL. An open division may be approved provided a minimum of five halter classes for stallions, a minimum of five halter classes for mares, a minimum of five halter classes for geldings and one performance class are offered.

SHW116.1 The halter classes must include individual classes for yearlings, 2-year-olds, 3-year-olds, 4-year-olds and older, and performance halter for American Quarter Horses.

SHW116.2 Show management will have the option of combining age groups into 2 and under and 3 and over with the unanimous consent of all exhibitors to be affected.

SHW116.3 Classes may be combined only if there are two or less entries in at least one of the halter age groups to be combined.

SHW116.3.1 Once halter age groups are combined and

additional entries are taken, it is mandatory that halter age groups be split to the originally requested classes should 1/2 point or more become available in each age group. Performance halter would continue to be offered as a separate class.

SHWII6.3.2 a Grand Champion and Reserve Champion must be selected for each sex in halter classes having three or more entries.

SHWII7. AMATEUR DIVISION APPROVAL. An amateur division may be approved separately or in conjunction with an AQHA-approved show for all ages and/or a youth show, provided at least four AQHA-approved amateur performance events are offered.

SHWII7.1 At show management's option, any number of performance classes may be offered as Select (ages 50 and over) and the exhibitor has the option of competing in the Select class or the all-age class.

SHWII7.1.1 Classes will be combined back to an all-age class should there be less than three entries in the Select or amateur class.

SHWII7.1.2 If additional entries are accepted resulting in three or more entries in both the select and amateur classes, classes must be split back the way they were originally offered.

SHWII7.1.3 Prior to posting patterns in pattern classes, show management is to assess entries in the amateur and Select classes. If, in show management's assessment it appears that amateur and Select classes could combine due to lack of entries, then show management will keep patterns consistent. If there are enough entries in both amateur and Select that they will be held separately, show management may use different patterns for the amateur and Select classes.

SHWII7.2 To have an approved amateur halter division, halter classes must include individual classes for yearlings, 2-year-olds, 3-year-olds, 4-year-olds and older, and performance halter for American Quarter Horses.

SHWII7.2.1 a Grand Champion and Reserve Champion must be selected for each sex in amateur halter classes having three or more entries.

SHWII7.3 Show management will have the option of combining age groups into 2 and under and 3 and over with the unanimous consent of all exhibitors to be affected.

SHWII7.3.1 Classes may be combined only if there are two or less entries in at least one of the halter age groups to be combined.

SHWII7.3.2 Once halter age groups are combined and additional entries are taken, it is mandatory that halter age groups be split to the originally requested classes should 1/2 point or more become available in each age group. Performance halter would continue to be offered as a separate class.

SHWII7.4 Show management has the option to offer amateur weanling halter classes in each sex division.

SHWII8. YOUTH DIVISION APPROVAL. A youth division may be approved separately or in conjunction with an AQHA-approved show for all ages provided a minimum of four approved youth per-

formance events are offered, two of which must be showmanship at halter and either western pleasure or western horsemanship.

SHWI18.1 To have an approved youth halter division, halter classes must include individual classes for yearling, 2-year-old, 3-year-old, and 4-year-old and older American Quarter Horse mares and geldings, as well as performance halter for AQHA registered mares and geldings.

SHWI18.1.1 A Grand Champion and Reserve Champion must be selected for each sex in youth halter classes having three or more entries.

SHWI18.2 Show management will have the option of combining age groups into 2 and under and 3 and over with the unanimous consent of all exhibitors to be affected.

SHWI18.2.1 Classes may be combined only if there are two or less entries in at least one of the halter age groups to be combined.

SHWI18.2.2 Once halter age groups are combined and additional entries are taken, it is mandatory that halter age groups be split to the originally requested classes should 1/2 point or more become available in each age group. Performance halter would continue to be offered as a separate class.

SHWI18.3 Show management has the option to offer youth weanling halter classes for both mares and geldings.

SHWI18.4 Age group limits in youth events may be set by show management. For horse show purposes, the age of an individual on January 1 of that year shall be maintained throughout the entire year. (Example: A youth who has a birthday in July, and is 18 years of age on January 1, must show throughout the entire year as an 18-year-old.)

SHWI18.5 It is recommended large classes be divided into age groups to provide more equal competition. Age divisions however, do not apply to halter classes.

SHWI18.5.1 If there is to be one class, undivided, the age group is to be 18 and under.

SHWI18.5.2 If there are to be two classes, the age divisions must be (1) 13 and under and (2) 14 – 18.

SHWI18.5.3 If there are to be three classes, the age divisions must be (1) 11 and under; (2) 12 – 14; and (3) 15 – 18.

SHWI18.5.4 Age groups may be combined at a show, at the direction of the judge and the show management with the unanimous consent of all exhibitors involved in the class only if there are two or less entries in one or both of the age groups to be combined.

SHWI18.5.5 The 11-and-under age group may never be combined with the 15-18 age group.

SHWI18.5.6 When the 11-and-under and 12-14 age groups are combined, that class shall be reported and shown as 14-and-under.

SHWI18.5.7 When the 12-14 and 15-18 age groups are combined that class shall be reported and shown as 12-18.

SHWI18.5.8 Age groups may never be split at the show.

SHWI18.5.9 Once age groups are combined and additional entries are taken, it is mandatory that age groups be split to the originally requested classes should 1/2 point or more

become available in each age group.

SHWI19. PERMITS Shows requesting that permits not be used due to safety factors or extenuating circumstances must be granted permission by AQHA prior to show approval.

SHWI20. INSPECTIONS/TESTING. If show management or an AQHA affiliate desires to conduct its own inspection, drug or surgical alteration testing, it must obtain written authorization from AQHA and instructions as to procedures and licensed veterinarians.

SHWI20.1 At an AQHA-approved show, only state or provincial affiliates or representatives of show management, acting pursuant to AQHA rules or AQHA, may request specimens of urine, saliva, blood or other substance for drug testing, or require payment of drug testing fees as a condition for entry.

SHWI20.2 For all AQHA-approved shows held in California, Canada or internationally, show management must collect a \$4 show processing fee per horse per show. For all AQHA-approved shows held in the United States, except California, show management must collect a \$4 show processing and \$1 drug testing fee (total of \$5) per horse per show.

SHWI20.3 Show management's failure to mail the fees to AQHA, postmarked within 10 days after the closing day of said show, may result in show approval being denied the following year.

SHWI20.4 Show management is exempt from collecting the above drug testing fee if the show in question is held in a state where the state government (not an affiliate): (1) operates an equine drug testing program, (2) collects a drug testing fee from shows held within said state, and (3) reports drug violations to AQHA.

SHWI20.5 Drug testing fees charged by an AQHA-approved show are subject to prior approval by AQHA.

SHWI20.6 The show manager shall forward to AQHA complete information, in writing, concerning a forbidden drug case or refusal to allow testing.

SHWI21. PREMIUM LISTS. Premium lists, show bill or class schedule must be submitted with show approval application.

SMHI21.1 Premium lists and entry forms should be printed to ensure uniformity.

SHWI21.2 Premium lists must include:

SHWI21.2.1 any prize money being offered (and the amount for each placing).

SHWI21.2.2 any award being given by show management as such may not be added at the show.

SHWI21.2.3 a list of show officers and officials

SHWI21.2.4 class schedule

SHWI21.2.5 exact location of the show

SHWI21.2.6 date or dates of the show

SHWI21.2.7 closing date for entries

SHWI21.2.8 exact date and time of judging.

SHWI21.3 A show is not required to award any existing unwon prizes.

SHWI22. ENTRIES An exhibitor is not required to enter a particular class or division to be eligible for competition. Entering a class(es) shall be the option of the exhibitor.

SHWI22.1 A show may not require an exhibitor to enter or pay entry fees for a horse in a halter class for that horse to be eligible to

compete in a performance class

SHWI22.2 A show may not require an exhibitor to enter or pay entry fees for a horse in a performance class for that horse to be eligible to compete in a halter class.

SHWI22.3 In order for a horse to be eligible for an all-around circuit award, show management may, at their discretion, require that such horse be exhibited in specified class(es) and/or categories.

SHWI22.4 In order for a horse to be eligible for a circuit award regarding a particular class, show management may not require that such horse be exhibited in class(es) other than the particular class in question.

SHWI23. ENTRY FEES may be charged, and if so, must be uniform to all exhibitors in the class, be collected by show management and paid by the entering party, not paid nor reimbursed by a third party, particularly another competitor in the class. All show fees shall be the same to all exhibitors within each respective division: open, youth, amateur, Level I youth and Level I amateur, and Rookie.

SHWI23.1 Entry fees, if charged, must be specified on the application for show approval.

SHWI23.2 Any scheduled class to be held with no entry fee must be so designated on the show application.

SHWI23.3 No change in specific entry fee shall be permitted after approval, unless the change can be published in at least one issue of *The American Quarter Horse Journal* prior to the scheduled date of the show. Violation will be cause for disqualification of the class.

SHWI23.4 It is strongly recommended that entry fees for Rookie, Level I and Level I classes be nominal.

SHWI23.5 Show management may offer discounted entry fees to Level I amateurs or Level I youth who exhibit in the corresponding amateur or youth class.

SHWI23.6 Show management shall maintain detailed written or electronic records, sufficient to establish to AQHA's satisfaction, upon request, that each exhibitor's entry fee was paid as required above. Such records shall be preserved for at least one year from the date of the show. Failure to maintain and preserve such record shall be cause for AQHA to disallow the class and refuse show results, or, if previously entered, remove them from AQHA's records.

SHWI23.6.1 Failure on the part of show management to maintain or preserve such records as required above shall create the presumption that the requisite fees in question were not paid in accordance with the above rule, with the burden of persuasion on show management and the individual exhibitor to prove otherwise.

SHWI23.7 If a horse per SHW904.1 or SHW904.5-6 is entered in a show, its entry fee shall be refunded and it is not to be exhibited.

SHWI24. TIES. No class is complete until all ties through point-earning places are broken.

SHWI24.1 If a tied contestant, or contestants, is disqualified in the runoff, he/she is not to be placed any lower than the lowest position for which he/she was tied.

SHWI24.2 Contestants disqualified during the first run are not considered to be tied for a place even if there were fewer than 10 different entries in the class.

SHWI24.3 Refer to the all-around trophy award for breaking ties for the all-around award.

SHWI25. RIBBONS. For AQHA-approved amateur, youth, Rookie/Level I amateur and Rookie/Level I youth classes, AQHA-approved shows are required to present ribbons or awards through sixth place. The following ribbons are recommended for halter and performance classes:

1st place..... blue	7th place purple
2nd place..... red	8th place brown
3rd place yellow	9th place..... dark gray
4th place white	10th place..... light blue
5th place pink	Grand Champion purple
6th place green	Reserve Champion... purple and white

SHWI26. SHOW RESULTS After conclusion of the AQHA-approved show, when AQHA receives all requisite reports from show management and has certified that the show has been conducted according to AQHA rules, show results and show points become official in AQHA's records, and retained on file at AQHA for two calendar years.

SHWI26.1 The results of any AQHA-approved show must be provided in its entirety.

SHWI26.2 Show management must submit a roster of all horses entered.

SHWI26.3 If a horse is disqualified, it is not to be placed, regardless of the number of horses in the class, but counts as an entry in the class.

SHWI26.4 Computerized show results must be used by show management; a sample format may be obtained, by request, from AQHA. Shows failing to submit show results in an accepted electronic format will not receive priority dates for the following year.

SHWI26.5 Show management (U.S. and Canada) will be fined at least \$50 per day for every day their show results are late after 10 days after the closing day of said show.

SHWI27. SHOW OFFICIALS are defined as any person performing the duties of a show manager, steward, ring steward or show secretary. Show officials, with the exception of ring stewards, must have a current AQHA individual membership. Any reputable person may act in the capacity of a show official who can furnish proof that he/she is capable through ability or experience.

SHWI27.1 No show official or member of their immediate family, any children or other relatives living in the same household of either or both of the married persons, or any person owning or leasing the grounds on which a show is being held whose ownership could influence the outcome of any show held on such property, shall enter or exhibit horses in any AQHA-approved open or amateur show at which he/she is officiating, nor may any horse owned by such person be entered and exhibited. Youth events and alliance shows, where it is acceptable by the rules of the alliance, are excluded from coverage under this rule.

SHWI27.2 Youth who perform show management duties are not eligible to exhibit in that approved show.

SHWI27.3 A show official's duties include, but are not limited to (1) contacting or hiring of judges; (2) acceptance of entries or entry fees; (3) having name and/or telephone number listed on the show application as a member of management, in *The American Quarter Horse Journal* or in any publication or show bill as the contact per-

son; and (4) having direction over the show, even though not listed on the application as show management.

SHWI28. SHOW MANAGERS shall:

SHWI28.1 be the person in charge of the AQHA-approved show, but may not serve as show secretary, ring steward or serve in any other capacity which might interfere with their effectiveness as manager;

SHWI28.2 be at least 18 years of age;

SHWI28.3 have authority to enforce all rules referring to the show and he/she may excuse any horse or exhibitor from the show or contest prior to or during the judging;

SHWI28.4 have jurisdiction over preparing and mailing all entry blanks, premium lists and catalogs and shall enforce the arrival and departure times as shown in the catalog or as advertised;

SHWI28.5 be present on the show grounds for the duration of the show. In the event an emergency arises and the show manager is unable to fulfill his/her duties, an acting manager should be appointed. The show manager must submit a written explanation to AQHA for his/her absence. The acting show manager must also remain on the show grounds for the duration of the show and must meet the requirements as set forth in this Rulebook;

SHWI28.6 at all times extend every effort to satisfy the comfort of the horses, exhibitors, spectators and officials and will be held responsible for maintaining clean and orderly conditions throughout the show;

SHWI28.7 be responsible for ensuring humane treatment of horses is adhered to on show grounds through policing of stalling areas and practice pens at various times throughout the show;

SHWI28.8 return cattle injury reports to AQHA where cattle classes are held;

SHWI28.9 receive written or verbal complaints from exhibitors, trainers, owners, show participants and other AQHA members of incidents of cruel, abusive or inhumane treatment of horses on show grounds or any other complaints or incidents of rule violations and shall forward such to AQHA;

SHWI28.10 upon a report or discovery of inhumane treatment, immediately investigate the incident and report it to AQHA. Show management shall make every effort to obtain the concurrence of any AQHA-approved judge on the grounds or AQHA-authorized personnel, if available. Any verbal or written warning performed by the show manager at a show for inhumane treatment is to be reported in writing to AQHA. If an incident is later reported to AQHA and knowledge is gained that the show manager was present but did not report the incident, this could jeopardize their ability to manage an AQHA-approved show in the future;

SHWI28.11 be subject to a review and a possible fine of \$100 for every hour or portion thereof past the 15-hour limit for one-day/one-judge shows which should not run more than 15 consecutive hours from the scheduled starting time to the conclusion of the show, including all breaks. Multi-day/one-judge shows, multi-day/multi-judge shows, and multi-judge/one-day shows should not exceed 15 hours per day from the judge's actual starting time to the conclusion of his/her last class.

SHWI28.12 post contact information of the show manager or other designated person who can be contacted in case of emergency; i.e. professional horseman, show steward.

SHWI29. Show management may:

SHWI29.1 immediately expel individuals exhibiting unsportsmanlike conduct from show grounds and shall file a written report with AQHA concerning the conduct in question;

SHWI29.2 establish ground rules with reference to the amount of time an exhibitor is allowed to begin his performance, dependent on the facilities and conditions. If such ground rules are established, show management should see they are enforced;

SHWI29.3 determine if an elimination is necessary, in the interest of successful implementation of the AQHA-approved show, the number of go-rounds to be held and the number of horses to be shown at each performance and to reasonably limit entries when necessitated by time and/or physical constraints of show premises when applied fairly and uniformly by a procedure in which all qualified entries are included in a random draw;

SHWI29.4 allow the name of the exhibitor and horse to be announced during any event.

SHWI30. SHOW SECRETARY. The show secretary may not hold the position of show manager or ring steward at a show at which he/she serves as show secretary and is responsible for:

SHWI30.1 accurately maintaining and recording both entries and show results, including verifying exhibitor eligibility and current membership and horse eligibility;

SHWI30.2 maintaining a set of results on file for at least one year from the show;

SHWI30.3 the entry fees, office charges, etc., and any fees collected for membership on behalf of AQHA and AQHYA. Cash payments made to the show secretary for these fees must be converted to a money order or check before being sent to AQHA;

SHWI30.4 ensuring only horses registered with AQHA compete in AQHA-approved shows. The exhibitor must present the registration certificate to show management, unless a photocopy of both sides of the registration certificate is acceptable to show management.

SHWI30.5 inspecting the registration certificate (or photocopy of both sides of the registration certificate if photocopy is acceptable to the show management or in the case of the new photo registration certificate only the front will apply) of each horse entered in an approved class. Failure to do so may result in cancellation of future show approval;

SHWI30.6 recording entries in the name of the record owner and the horse's complete registered name and number, with the designation of Appendix following its name to be eligible for AQHA points.

SHWI31. RING STEWARD. A competent ring steward is required at all AQHA-approved shows for each judge and may not hold the position of show manager or show secretary at a show at which he/she serves as a ring steward and shall:

SHWI31.1 wear appropriate western attire which includes pants (slacks, trousers, jeans, etc.), long-sleeve shirt with collar (band, standup, tuxedo, etc.) and cowboy boots. Western hat is optional;

SHWI31.2 relieve the judge of unnecessary details, assemble the class promptly, keep the judging program on schedule, eliminate long delays between classes and control the conduct of the horses and exhibitors in the ring;

SHWI31.3 notify the judge when all horses are present for each class and call his attention to those horses that are absent;

SHWI31.4 ensure no person rides more than one horse in any approved performance class, except as allowed under SHW400;

SHWI31.5 assist the judge, not advise him/her and shall refrain from discussing, or seeming to discuss, the horses or the exhibitors with the judge;

SHWI31.6 not take part, or seem to take part, in any of the judging.

SHWI31.7 when not actively engaged in his/her duties, place himself/herself in such a position so as not to interfere with the judging and the view of the spectators.

SHWI31.8 not allow exhibitors to crowd up in the ring or arena and, at all times, endeavor to keep the possibilities of an accident at a minimum;

SHWI31.9 have charge of the activity in the ring or the arena. He/she should act as mediator between the judge and the exhibitor. The judge should request the ring steward to move and place horses as he/she advises. When the ring or arena size is small and the class entries are large, he/she should survey the situation and take every precaution to keep the horses moving until the judge is ready for them to be judged. He/she has the authority to ask an exhibitor to remove his or her horse for the safety of other horses or spectators;

SHWI31.10 have the authority to remove unsportsmanlike exhibitors from the arena;

SHWI31.11 be familiar with the procedure of sifting, when the classes are large and the judge requests that he/she line them up for the first sift, the second sift, and so on, until the judge has his/her class ready; and

SHWI31.12 where applicable, lineup the class placings the same in every class-I, 2, 3, 4, 5, 6, 7, 8, 9, 10, 11.

SHWI32. VETERINARIAN. At show management's option, any Licensed Veterinarian may serve as a show veterinarian. If there is more than one veterinarian, one should be delegated as being in charge. Health requirements should be outlined in catalogs and on entry blanks and enforced by the show manager and veterinarian.

SHWI33. AQHA STEWARDS. Designation as an AQHA Steward is a privilege, not a right, bestowed by the Executive Committee according to procedures formulated by it, to individuals whose equine expertise and personal character merit the honor. An individual's conduct as an AQHA Steward must be exemplary and is subject to continual Executive Committee review, with an automatic review after three years of becoming an AQHA Steward. Designation as an AQHA Steward is revocable by the Executive Committee at any time with or without cause and with or without notice and formal hearing.

SHWI34: AQHA Steward's responsibilities include:

SHWI34.1 monitoring show grounds for inhumane treatment of horses and unsportsmanlike conduct;

SHWI34.2 answering exhibitors' questions about rules;

SHWI34.3 assisting show officials with proper set up of practice jumps and courses;

SHWI34.4 investigating complaints of class filling;

SHWI34.5 evaluating potentially unsafe conditions related to the show, e.g. poor footing in the warm-up area, and bring to attention of show management to correct;

SHWI34.6 issuing warning or removal cards from show ground as warranted according to AQHA rules and/or guidelines;

SHWI34.7 timely filing an AQHA Steward's report and evaluation with AQHA; and

SHWI34.8 adhering to the AQHA Stewards Code of Ethics.

SHW200. EFFECTIVE DATE AND REPEAL. These rules and regulations become effective January 1, 2016. Rules as printed in the *AQHA Official Handbook* shall be used at all AQHA-approved shows, the AQHA World Championship Show, the AQHA Select World Championship Show, AQHYA World Championship Show, AQHA Versatility Ranch Horse World Championship Show, Level I (Novice) Championship Shows, and Regional Championship Shows.

SHW201. GENERAL PROVISIONS.

SHW201.1 Additional rules and regulations pertaining to AQHA's World Championships Shows can be found in the appropriate World Show Handbook and also located in the back of this Official Handbook or on line at aqha.com.

SHW201.2 For any payment required, such is due at the time of processing and payable in U.S. funds only. Mailing address: P.O. Box 200, Amarillo, Texas 79168. overnight delivery address: 1600 Quarter Horse Drive, Amarillo, Texas 79104. 806-376-4811.

SHW201.3 Through the payment of a membership fee to AQHA, an individual acknowledges that membership in AQHA is voluntary and agrees to be bound by all terms and conditions provided in this *official handbook*.

SHW201.4 A required form must be properly completed in its entirety and signatures provided as requested

SHW201.5 AQHA or AQHYA members may be disciplined, suspended, fined and/or expelled from AQHA and/or AQHYA, and a nonmember may be denied AQHA privileges for violations or fraudulent practices per VIOLATIONS in this rulebook.

SHW201.6 Exhibitors are expected to conform to all class rules from the time they enter the show arena until they exit the show arena.

SHW202. AQHA SHOWS offer a variety of classes (English, halter, western) and levels of competition including Rookie, Level 1, Level 2 or Level 3. Refer to TYPES OF SHOWS.

SHW205. ANIMAL WELFARE. Every American Quarter Horse shall, at all times, be treated humanely and with dignity, respect and compassion. This prohibition against inhumane treatment applies to AQHA members and nonmembers.

SHW205.1 AQHA members may be held responsible for the actions of their trainers, agents, representatives and/or employees. For violation of this rule, an individual may be disciplined, suspended, fined, denied AQHA privileges, disqualified, expelled from show grounds and/or expelled from AQHA.

SHW205.2 The standard by which conduct or treatment will be measured is that which a reasonable person, informed and experienced in generally accepted equine care, training and exhibition procedures or veterinary standards, would determine to be cruel, abusive or inhumane.

SHW205.3 Refer to VIOLATIONS in this rulebook for comprehensive rules on animal welfare.

SHW210. DISCLAIMER OF RESPONSIBILITY FOR SAFETY OF SHOW PARTICIPANTS:

SHW210.1 Show management is responsible for the condition of show premises, including, but not limited to, arena, exercise, and stall areas; the conduct and competence of show employees

and other representatives; implementation of show activities and events; and all other aspects of the show.

SHW210.2 AQHA does not assume or accept duty or responsibility for safety at any show in regard to participants or any other third parties, or for the horses or other property thereof.

SHW210.3 As an express condition of the privilege to participate at an AQHA-approved show or event, each owner of an American Quarter Horse, exhibitor, trainer and participant assumes the risks of participation, and releases and discharges AQHA, its officers, directors, representatives and employees from any and all liability, whenever or however arising, as to personal injury or property damage occurring as a result of participation in an event conducted by the show or on the show grounds thereof.

SHW210.4 Without assuming the affirmative duty to monitor possible physical or mental handicaps of exhibitors, if a condition of exhibitor's physical or mental disability comes to the attention of AQHA, the individual may be denied participation privileges in AQHA-approved events until such time as he or she provides AQHA with sufficient information to conclusively establish physical or mental capability to participate, without posing a significant risk to the health or safety of the individual and/or the other exhibitors of the class in which he or she desires to participate. At AQHA's sole discretion, the individual may be authorized to use special equipment to enhance the physical ability to safely exhibit in AQHA-approved events.

SHW215. ELIGIBILITY FOR PARTICIPATION. All AQHA-approved classes must be open to any American Quarter Horse owner meeting age, ownership and eligibility requirements. Membership in AQHA and/or AQHYA for youth competition is the only mandatory membership.

SHW215.1 Every person competing in an AQHA-approved class must possess either a current, individual AQHYA or AQHA membership card, or AQHA membership card with amateur privileges, recorded solely in their name, or must complete a membership application and pay for it at the show, which will be submitted with the show roster. The exhibitor must accurately complete entry forms and assumes responsibility for errors.

SHW215.2 Show management must inspect the membership card (or a photocopy) at any show the exhibitor has entered. If the exhibitor is a member but cannot produce the card (or a photocopy) at the show, a replacement form must be completed and a new membership purchased at the show prior to entering. This fee is non-refundable.

SHW215.2.1 To allow show management qualification for monetary assistance from a state, province or country in which an AQHA-approved show or event is conducted, in which state, province or country prohibits exclusion of nonmembers, if otherwise qualified, a nonmember may gain entry in the open and youth divisions by payment of a nonmember fee equal to an individual member fee. Payment of this fee will allow a nonmember access to the particular event, show, or show circuit. By entering as a nonmember, the individual agrees to abide by AQHA rules.

SHW215.3 Each member, horse owner or others involved in participation in AQHA-approved events is charged with the ulti-

mate responsibility to determine eligibility of persons exhibiting his or her horse by contacting AQHA regarding the current list of suspended or disciplined persons before authorizing such participation.

SHW215.4 Any stallion, mare or gelding one year old or older must have been issued an AQHA registration certificate to compete in an AQHA-approved halter class.

SHW215.5 Only stallions, mares, spayed mares, non-breeding mares and geldings, 2 years old and older, which have been issued an AQHA registration certificate, are eligible to compete in approved performance classes or contests.

SHW215.6 A 2-year-old may not be shown in any performance class prior to July 1 of its 2-year-old year with the exception of yearlings that may compete and earn points in showmanship at halter classes.

SHW215.7 Geldings still listed as stallions according to AQHA records at the time the show results are processed will be disqualified.

SHW215.8 Weanlings may be exhibited without a registration certificate but must be shown as unnamed; must be eligible for registration with AQHA. Either before or after a registration application is filed, should AQHA determine the weanling is either ineligible for registration or eligible only upon fulfillment of certain conditions, the weanling shall not further participate in AQHA-approved shows, or, if registration is conditional, it shall not participate in AQHA-approved shows until those conditions are fulfilled.

SHW215.9 Stallions may not be exhibited in Rookie, Level I amateur or Level I or youth, or any youth classes, except for youth ages 14 and older residing in Mexico, South or Central America who may exhibit stallions in youth performance classes if such classes are held in Mexico, South and/or Central America.

SHW220. AMATEUR AND YOUTH HORSE OWNERSHIP REQUIREMENTS. In addition to the requirements of the ELIGIBILITY FOR PARTICIPATION, AMATEUR ELIGIBILITY and/or YOUTH ELIGIBILITY, and unless otherwise permitted pursuant to AQHA rules and regulations, any horse exhibited in the youth or amateur division must be solely owned by the contestant showing the horse or the contestant's immediate family.

SHW220.1 IMMEDIATE FAMILY includes: spouse, child, stepchild, parent, grandparents, grandparent's siblings, step-grandparent, grandchild, step-parent, sibling, half-sibling, step-sibling, spouse's parent, spouse's step-parent, sibling's spouse, half-sibling's spouse, step-sibling's spouse, sibling's child, sibling's step-child, half-sibling's child, half-sibling's step-child, step-sibling's child, step-sibling's step-child, parent's sibling, parent's half-sibling, parent's step-sibling, parent's sibling's child, parent's sibling's stepchild, parent's half sibling's child, parent's half sibling's stepchild, parent's step sibling child, parent's step sibling's stepchild, legal ward or legal guardian. Persons whose relationship is legally recognized as a domestic partnership or civil union under the laws of the jurisdiction in which they sought such relationship are considered immediate family. Separate legal entities, such as family corporations, trusts or partnerships, are also authorized owners of the ama-

teur exhibitor's horse so long as all legal and equitable owners and beneficiaries of the legal entity are individuals specifically authorized by this rule.

SHW220.2 "Owned" means, in addition to other legitimate methods of acquiring ownership, the bona fide legal ownership obtained for adequate consideration in reasonable relationship with the actual market value of the horse. For example, a \$5 payment for a world championship quality horse does not meet the required character of required ownership for competition in the amateur or youth division. The relationship of the amateur or youth to the owner of the participating horse must be evidenced by submitting legal documentation (i.e. copies of marriage and/or birth certificates) to AQHA's Competition Department. Ownership must be evidenced by AQHA records and the registration certificate of such horse must show such person as the owner by proper endorsement of AQHA at the time the horse is entered in any youth or amateur show or class.

SHW225. AMATEUR ELIGIBILITY. The application for amateur membership must be true and correct in every detail. A false statement shall be grounds for possible disciplinary action under AQHA's disciplinary procedure (VIOLATIONS), which includes suspension, fine and/or expulsion from membership. In addition to the membership requirements, the following rules apply. An amateur:

SHW225.1 must be 19 years of age on or before January 1 of the year of application and no longer eligible to compete in AQHA youth classes

SHW225.2 may show in Select amateur classes upon turning 50 years of age.

SHW225.3 for three years from the date of the last incident which rendered the individual ineligible previous to application for amateur membership, an amateur may not have:

SHW225.3.1 shown, judged, trained or assisted in training a horse (whether or not a registered American Quarter Horse) for remuneration, monetary or otherwise, either directly or indirectly. Payment of entry fees and/or expenses by anyone other than the amateur, the amateur's "Immediate Family" as defined herein or an amateur's nationally sponsored team (team demonstrations, exhibitions or international competitions only) shall be considered remuneration;

SHW225.3.2 instructed another person in riding, driving, training or showing a horse (whether or not a registered American Quarter Horse) for remuneration, monetary or otherwise, either directly or indirectly;

SHW225.3.3 shown, trained or assisted in the training of a horse (whether or not a registered American Quarter Horse) for which an immediate family member accepts remuneration, monetary or otherwise, either directly or indirectly, for such services;

SHW225.3.4 held credentials of horse show judge for AQHA or any other equine organization;

SHW225.3.5 been a member of the American Quarter Horse Association of Professional Horsemen; or

SHW225.3.6 held membership accreditation with the

Professional Rodeo Cowboys Association, Women's Professional Rodeo Association (Barrel Race Only) or International Professional Rodeo Association, for those events or classes which are the same events or classes in which the individual competes, or desires to compete, in AQHA amateur competition. For example, a person who competes in a PRCA roping event may not compete in amateur calf roping or dally team roping (heading or heeling) but may show in any other amateur classes. A permit holder is not considered as one who has membership accreditation in a professional organization and may compete in any AQHA-approved amateur class.

SHW225.4 Notwithstanding SHW225.3.3-4 above, certification as an instructor in equitherapy by Professional Association of Therapeutic Horsemanship International (PATH) or similar organizations recognized by AQHA shall not result in amateur ineligibility. AQHA shall maintain a list of such recognized organizations. To be eligible as an AQHA amateur, the excepted instructor may only teach students enrolled with the recognized organization or prescribed such rehabilitation by a licensed medical doctor. Any amateur competitor excepted under this provision shall file such certification with the AQHA Amateur Department prior to any competition by such individual.

SHW225.5 Notwithstanding SHW225.3.4 above, an individual who is 65 years of age or older and holds horse show judging credentials for AQHA or any other equine organization but has not judged in the previous twelve months is eligible to immediately apply for amateur membership so long as he/she meets all other amateur eligibility requirements and relinquishes his/her horse show judging credentials.

SHW225.6 Notwithstanding SHW225.3.5, an individual who is 65 years of age or older and is a member of the American Quarter Horse Association of Professional Horsemen is eligible to immediately apply for amateur membership so long as he/she meets all other amateur eligibility requirements and relinquishes their Professional Horsemen membership.

SHW225.7 Notwithstanding SHW225.3.6 above, an amateur member who is eligible to compete as a Select amateur and has earned Gold Card status with another association or organization is eligible to compete in any AQHA-approved amateur class so long as he/she has not activated his/her Gold Card to be eligible to compete within the other association or organization.

SHW226. As a condition for the issuance of amateur membership, the applicant, and/or the family member who actually owns the horse with which the amateur will participate, agrees to provide, upon request, such documentation or other proof as requested by AQHA to support the representations of sole economic ownership of the horse or horses exhibited by the amateur in amateur or open events, and the other criterion set forth above. Failure to promptly furnish such documentation upon request may be cause for immediate termination of amateur membership and be grounds for possible disciplinary action by the Executive Committee under AQHA disciplinary procedures.

SHW227. To become eligible for amateur membership, or become eligible for reinstatement to amateur membership, the individual must wait a period of up to three years from the date of

the last incident which rendered the individual ineligible. Violation of AQHA's rule requirement for truthful application for amateur status may be cause for more severe sanction than such waiting period.

SHW228. If a record owner (1) leases a horse for breeding purposes only and (2) retains sole right of competing with the horse, such record owner may exhibit the horse in open or amateur AQHA classes.

SHW229. Upon revocation of amateur membership because of ineligibility, all earned amateur points from time of violation of eligibility rules shall be revoked.

SHW230. AMATEUR PERMITS. Amateur card holders may ride horses owned by someone other than immediate family members in any open division performance class for which they have been granted exemption by AQHA with no penalty, provided the amateur member pays all entry fees and expenses in connection with showing. Upon written request to AQHA's Competition Department, and after receiving from them a permit authorizing such, an amateur member will be permitted to exhibit a horse he/she does not own in open division classes at a maximum of two AQHA-approved shows. The amateur member seeking exemption must submit to AQHA's Competition Department the names and exact dates of the two shows, as well as the horse's name and AQHA registration number which they will exhibit.

SHW230.1 Only one such permit will be granted for a rider for a given horse, and no AQHA points will be awarded.

SHW230.2 Show management shall not allow a non-owned horse to be shown by an amateur member in the open division unless exhibitor has said permit at the time of entry. Failure to properly obtain permit prior to showing may result in revocation of amateur status and/or other penalties.

SHW235. YOUTH ELIGIBILITY. As a condition for the issuance of youth membership, the applicant and/or the family member who actually owns the horse with which the youth will participate, agrees to provide, upon request, such documentation or other proof as requested by AQHA to support the representations of sole economic ownership of the horse or horses exhibited by the youth in youth events, and other criteria set forth above. Failure to promptly furnish such documentation upon request may be cause for immediate termination of youth membership and be grounds for possible disciplinary action by the Executive Committee under AQHA disciplinary procedure for failure to respond to request for information.

SHW236. Although a youth may show a non-owned horse in the open division, doing so could violate AMATEUR ELIGIBILITY.

SHW240. AMATEUR AND YOUTH SHOWING LEASED HORSES. Amateurs and youth may show leased horses subject to the following:

SHW240.1 prior to the lessee (amateur or youth) showing the leased horse, AQHA must have received and recorded a showing lease form;

SHW240.2 the lessee must be responsible for expenses associated with the care of the horse: boarding, feeding, routine farrier services and routine veterinary services;

SHW240.3 during the term of the showing lease, only the lessee and lessee's IMMEDIATE FAMILY may show the horse. The

lessee's trainer may also show the horse during the term, but only in open division events **During the term of the lease, the horse may be shown by other eligible exhibitors in the Open Division events only;**

SHW240.4 the term of the lease must be for a minimum one year period, and the lease must be to an individual only. **If the lease is terminated for any reason before the minimum one year period, the horse can only be shown in the Open Division until the term of the lease is complete; Except as provided by the International Lease for World Championship Show rules;**

SHW240.5 only one showing lease at a time per horse will be recognized;

SHW240.6 a showing lease does not grant a lessee or lessee's agent authorization to sign breeder's certificate(s), stallion breeding reports, transfers or registration applications for the horse;

SHW240.7 During the term of a showing lease, subsequent changes in ownership will not be recorded until the showing lease is terminated;

SHW240.8 if a lessee qualifies the horse for and intends to exhibit the horse at an AQHA World Show, a showing lease must be in effect and on file with AQHA at the time the lessee (a) enters the horse into the World Show and (b) exhibits the horse at the World Show. **Subject to SHW240.4** should a showing lease expire prior to the above times, a new showing lease will be required.

SHW245. LEVEL I ELIGIBILITY – Every person competing in Level I amateur or Level I youth class must possess an amateur or youth membership card.

SHW.245.1 Level I eligibility point ranges will be established every year for each class. Class point ranges are based on the cumulative average of all Level I competitors, per class, during the three immediate previous calendar years. Level I eligibility point cap will be greater of 25 points or the 90th percentile. Level I eligibility point ranges and percentiles, per class can be found at aqha.com/leveling.

SHW 245.2 Level I points are not recorded on a horse's performance record; points are recorded on the exhibitor.

SHW 245.3 When determining eligibility for a level in a particular class, an individual/ horse may not have exceeded the point cap described in SHW245.1 for that particular class. In addition, at the time of application for level I an individual may not have earned a superior award in a particular class in any equine organization or association with a membership of more than 7,500 members (including AQHA): placed in the top 10 at any AQHA World Championship Show in a particular class; won a world, reserve world, national or reserve national championship title in a particular class(excluding level I class) in any equine organization or association with a membership of more than 7,500 members; won an international or reserve international title for that particular class at the European Championships or German Championships regardless of whether the international class in question was an AQHA –approved class; or won a total of \$5,000 in cash and prizes with any equine organization or association. **If an exhibitor wins a class at the Level I Championships he/she is no longer eligible to compete in that**

class at any future Level I Championships; however, if an exhibitor is Level I eligible he/she may continue to show in that class in Level I competition.

If an exhibitor has not reached any of the above achievements but has pointed out of level I, the exhibitor can only return to level I in that particular class if the exhibitor has not earned any points in that class for 10 consecutive years and must meet eligibility requirements per Rule SHW245.3.

SHW 245.4 Once an exhibitor is assigned a level for a given show year, they are eligible to compete in that level for the entire year.

SHW 245.5 Any individual who has been an accredited horse show judge or who has trained professionally will not be eligible to participate in Level I competition.

SHW245.6 Points earned in Level I may not be used for any amateur or youth awards, or any world show qualification.

SHW245.7 Applicants are responsible for verifying eligibility for any class/level regarding earned halter and performance points. Applicants may contact AQHA concerning halter and performance points that have been reported to AQHA and recorded in AQHA's records.

SHW245.8 Level I exhibitors may participate on a non-owned horse in Level I classes only at AQHA-approved shows without the use of permits. The recorded owner retains the ability to show the same horse in any class other than the same class as the Level I exhibitor. This option is not available to competitors at the top 10 show circuits. The top 10 show circuits can be found at *aqha.com* will be determined by the number of entries in the previous year. For the top 10 shows (provided the show accepts permits), a Level I amateur or Level I youth member may apply for up to 10 permits allowing them to compete with one permit per show on a non-owned horses in Level I classes only. Points earned by Level I, whether using permits or not, will count toward the point cap per class for Level I eligibility. Applications for permits shall be directed to the AQHA competition department on application forms provided by AQHA or an application may be filled out at an AQHA-approved show, and be granted as AQHA, in its sole discretion, determines. Exhibitors must have a current amateur or youth membership to participate. All Level I rules still apply whether using permits or not.

SHW245.9 A youth member wanting to show a college or university owned or leased horse in Level I classes only must meet the following requirements:

SHW245.9.1 the individual must be a current AQHYA member or an AQHA amateur member prior to the AQHA-approved show at which they wish to compete;

SHW245.9.2 the individual must request an application from AQHA to be eligible to participate in this program. The application must be submitted and approval must be received prior to participating in the AQHA-approved show. A letter will be sent to the applicant either confirming or denying the application. If the application is approved, the letter must be presented to the show secretary at time of entry;

SHW245.9.3 the following items must be submitted with the application: verification that the individual is

enrolled in 12 credit hours per semester, signature of college or university equestrian team coach or equine program instructor, list of college or university owned or leased horses that the individual will be showing and photocopy of student identification;

SHW245.9.4 for AQHA purposes the spring semester will be from January 1 - June 30 of the current year and the fall semester will be from July 1 - December 31 of the current year.

SHW250. LEVELING - YOUTH, AMATEUR, OPEN DIVISIONS- Youth and amateur division classes will be based on the exhibitor's show record. Open division classes, with the exception of cattle and halter classes, will be based on the horse's record. Open division cattle and halter classes will be leveled by exhibitor record. Rookie eligibility for horse and exhibitor is based on lifetime points earned by class. Open level 1 eligibility is based on lifetime points and money earned by class. Horse and rider eligibility, for all other levels, is calculated on a three-year cumulative time period of November 1 through October 31 to determine the horse and rider eligibility level(s) for the next competition year.

SHW 250.1 Classes based on exhibitor performance are those in the 1) amateur 2) youth and 3) open division halter and cattle only.

SHW250.2 Classes based on horse performance are open division, excluding halter and cattle.

SHW250.3 Exhibitors must designate which level they are entering. If no specific level is designated he/she will automatically be placed in Level 3.

SHW251. LEVEL ELIGIBILITY. Level eligibility will be effective January 1 of each year and the exhibitor or horse will remain eligible for that level for the entire calendar year, regardless of the number of points earned during the year.

SHW251.1 Throughout the year, horses or exhibitors may show at a higher level than what they are eligible, but cannot show to a level below their eligible level.

SHW 251.2 A horse which points out level 1 may continue to show in level 1 for the remainder of the calendar year. After that calendar year, however, that horse may never return to level 1.

SHW251.3 Exhibitors and horses can return to level 2 based on points earned during the calculation period in future years due to the lack of points earned in the previous three year period. However, the following occurrences prevent returning:

SHW251.4 Horses placing in the top ten in Level 3 classes at the open World Show are no longer eligible for Level 1 beginning the following year in that class.

SHW 251.5 Exhibitors placing in the top ten in the Level 3 classes at the Built Ford Tough AQHYA, Open/Amateur or Adequan Select World Shows, are no longer eligible for Level 1 beginning the following year and can never be eligible for Level 1 in that class.

SHW251.6 Competitors placing in the top two in the Level 3 classes at the Built Ford Tough AQHYA, Open/Amateur or Adequan Select World Shows are not eligible for Level 2 for the subsequent three years in that class within that division, regard-

less of points earned in the past three years.

SHW251.7 Level 3 exhibitors placing in the top ten in halter or cattle classes at the Open World Show, will no longer be eligible for Level I in that class beginning the following year and can never be eligible for level I in that class.

SHW251.8 Horses placing in the top two in the Level 3 classes at the Open World Shows are not eligible for Level 2 for the subsequent three years in that class, regardless of points earned in the past three years.

SHW251.9 Horses in their first year of senior competition will automatically be eligible for Level 2 unless the horse places in the top two in a level 3 class at the Open World Show. In this instance, the horse is not eligible for Level 2 for the subsequent three years in that class, regardless of points earned in the past three years.

SHW252. ROOKIE LEVEL. Rookie eligibility is based on lifetime achievements of exhibitor and horse.

SHW252.1 For a horse or exhibitor to be eligible in a Rookie Level class, that horse or exhibitor must have earned fewer than ten lifetime points in that class in any division; open, amateur or youth. Eligibility is from January 1- December 31.

SHW252.2 Notwithstanding the ownership requirements associated with competing in youth and amateur classes, ownership of the horse is not required to participate in Rookie level classes. Multiple exhibitors, including the record owner, may show the same horse in any class at a show (assuming eligibility requirements for class are met), but not in the same Rookie level class(es) at that particular show.

SHW252.3 Youth and amateur Rookie level performance classes can be run as stand-alone classes or concurrently with corresponding Level I classes. Open division Rookie level performance classes can be run as stand-alone classes or concurrently with corresponding AQHA Level I classes. If an exhibitor is eligible to show in the Rookie class and the corresponding Level I class, they may enter both classes.

SHW252.4 Rookie level halter classes must be all-aged classes and must be held as stand-alone classes. Rookie level halter classes are not eligible for grand and reserve awards.

SHW255. EXHIBITORS CONDUCT

SHW255.1 To make a formal complaint against an AQHA-approved exhibitor, such complaint must be in writing, signed by the complainant, contain specific facts giving rise to the complaint, and be received by AQHA within a reasonable time from the date of occurrence. By filing this complaint, the complainant agrees to attend a hearing, if any, conducted by AQHA in regard to the matter either at AQHA offices in Amarillo, Texas, or as the Executive Vice President directs.

SHW255.2 Exhibitors shall not contact, nor attempt to contact the judge pertaining to judging of any horses at that show. Further, exhibitors shall not approach judges for any reason prior to the completion of judging unless the ring steward is present.

SHW255.3 No exhibitor will visit or socialize with a judge the day prior to or day of the show.

SHW255.4 An AQHA-approved judge shall be treated with courtesy, cooperation and respect. No person, exhibitor, owner,

or otherwise, shall direct abuse or threatening conduct toward them, either in the furtherance of their judging duties, or as a result thereof, whether or not the conduct occurs during an approved event or show, or on or off show grounds.

SHW260. POINTS. Points shall be awarded to qualifying 2-year-old and older horses entered and exhibited in AQHA-approved shows and performance events, and to yearlings entered and exhibited in their appropriate halter and showmanship classes only, according to the chart on the following page.

SHW260.1 All AQHA-approved classes must meet minimum entry requirements to receive designated points.

SHW260.2 In any performance class, points shall be awarded based on the total number of eligible horses actually judged in that class, whether or not an elimination was held. For example, if 45 horses were entered and exhibited in an elimination, points would be based on 45 entries, even though entry fees may have been returned on horses which were worked and eliminated.

SHW260.3 No class of less than three horses shall receive points, but all classes shall be judged.

SHW260.4 Points awarded in amateur or youth classes will be designated as such and not be considered for any other AQHA designation, award, registry or title.

SHW 260.5 Points earned in rookie or Level I classes do not count toward World Show qualification or Incentive Fund payout.

SHW 260.6 Points earned in Amateur, Youth and Open Levels 2 and 3 will count toward World Show qualification.

SHW 260.7 Points earned in Amateur and Open Level 2 and 3 will be eligible for AQHA Incentive Fund payout.

SHW260.8 Points in the amateur and youth divisions are to be compiled on a one horse - one amateur or one youth basis and will count toward any award so long as the amateur or youth ownership requirements are met as outlined. In the event the horse is sold, a new start will be made by the new exhibitor, except when a horse is repurchased or otherwise reacquired by the seller, in which event previously earned points will be reinstated except for World Show qualification.

SHW260.9 The Grand Champion of sex divisions with three or more entries will receive one-half point more than any other entry one year old and older. In sex divisions with five or more entries, the Grand Champion will receive one point more than any other entry one year old or older except the Reserve Champion. If necessary, additional points will be added to points the Grand Champion won in its age class to give it this total. AQHA will note the awarding of Grand Champion stallion, mare or gelding on the horse's performance record only when at least three horses of any age are exhibited in the sex division. i.e. if the Grand Champion Stallion received three points for being first in its class, and the first-place stallion in another class also received three points, the Grand Champion Stallion will be given one point more so it will have a point more than any other horse of its sex division.

SHW260.9.1 If the Grand Champion Stallion received three points for being first in its class, and no other stallion received more than two points in its class, no additional points will be awarded to the Grand Champion Stallion.

SHW260.9.2 The Reserve Champion of sex divisions with three or four entries will receive as many points as any other

horse one year old and older in its sex division except the Grand Champion. In sex divisions with five or more entries, the Reserve Champion will receive one-half point more than any other entry one year old and older in its sex division except the Grand Champion. If necessary, additional points will be added to points the Reserve Champion won in its age class to give it this total. i.e. if the Reserve Champion Stallion received two points in its class and another stallion, which was not the Grand Champion Stallion, received three points in its class, the Reserve Champion Stallion will be given 1 1/2 points more so it will have one-half point more than any other horse in its sex division except the Grand Champion Stallion.

SHW260.9.3 If the Reserve Champion Stallion received two points in its class and no other stallion (except the Grand Champion Stallion) received more than 1 1/2 points, no additional points will be awarded to the Reserve Champion Stallion.

SHW261. POINTS CHART

No. of

entries in class	1st	2nd	3rd	4th	5th	6th	7th	8th	9th	10th
3-4	1/2									
5-9	1	1/2								
10-14	2	1	1/2							
15-19	3	2	1	1/2						
20-24	4	3	2	1	1/2					
25-29	5	4	3	2	1	1/2				
30-34	6	5	4	3	2	1	1/2			
35-39	7	6	5	4	3	2	1	1/2		
40-44	8	7	6	5	4	3	2	1	1/2	
45 & more	9	8	7	6	5	4	3	2	1	1/2



One simple test can improve the care and performance of your American Quarter Horse.

Doing your part is easy. Order the Panel Test from AQHA today*. Members \$85, Non Members \$125.

AQHA

To order a test or learn more call 806-376-4811

*Panel test is required for stallions breeding 25 or more mares

SHW300. EQUIPMENT.

SHW300.1 When exhibitor equipment failure causes a delay or a run to be discontinued, the judge will disqualify the entry, except in working hunter and jumping.

SHW300.2 In any approved class, the judge shall have the authority to require the removal or alteration of any piece of equipment or accoutrement which is unsafe, or in his opinion, would tend to give a horse an unfair advantage or which he believes to be inhumane.

SHW300.3 Tails may be lengthened by hair attachment only with no attachments of any kind to the tailbone.

SHW300.4 The use of weighted tails is acceptable.

SHW300.5 The use of earplugs or cotton in the horse's ears is acceptable.

SHW300.6 Reruns will not be allowed in instances of equip-

ACCEPTABLE CHAIN CURB STRAPS



WESTERN BITS

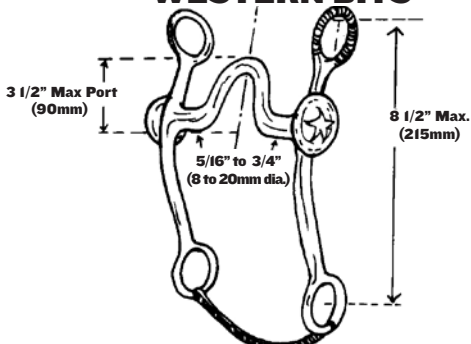

LEGAL BIT

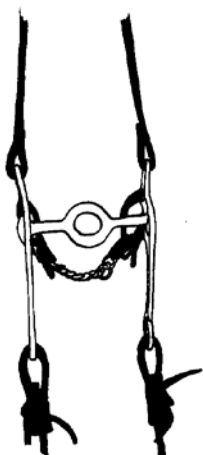

DONUT BIT

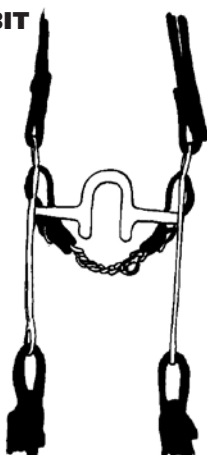

PRONG BIT

ILLEGAL BIT

ment failure.

SHW300.7 Failure by exhibitor to wear correct number(s) in a visible manner shall result in disqualification.

SHW305. WESTERN EQUIPMENT.

SHW305.1 Hackamore means the use of a flexible, braided rawhide, leather or rope bosal, the core of which must be flexible. A hackamore must use a complete mecate rein, which must include a tie-rein. Absolutely no rigid material will be permitted under the jaws, regardless of how padded or covered. Horse hair bosals are prohibited. This rule does not refer to a mechanical hackamore.

SHW305.2 Snaffle bits in western performance classes mean the conventional O-ring, egg-butt or D-ring with a ring no larger than 4" in diameter (100 mm). The inside circumference of the ring must be free of rein, curb or headstall attachments which would provide leverage. The mouthpiece should be round, oval or egg-shaped, smooth and unwrapped metal. It may be inlaid, but smooth or latex-wrapped. The bars must be a minimum of 5/16" (8 mm) in diameter, measured one inch (25 mm) in from the cheek with a gradual decrease to center of the snaffle. The mouthpiece may be two or three pieces. A three-piece, connecting ring of 1 1/4" (32 mm) or less in diameter, or a connecting flat bar of 3/8" to 3/4" (10 mm to 20 mm) measured top to bottom, with a maximum length of 2" (50 mm), which lies flat in the horse's mouth, is acceptable. Optional leather strap attached below the reins on a snaffle bit is acceptable.

SHW305.3 Bit in western performance classes means the use of a curb bit that has a solid or broken mouthpiece, has shanks and acts with leverage. All curb bits must be free of mechanical device and should be considered a standard western bit.

SHW305.4 The description of a legal, standard western bit includes:

SHW305.4.1 8 1/2" (215 mm) maximum length shank to be measured as indicated in the diagram on the previous page. Shanks may be fixed or loose;

SHW305.4.2 concerning mouthpieces, bars must be round, oval or egg shaped, smooth and unwrapped metal of 5/16" to 3/4" (8 mm to 20 mm) in diameter, measured 1" (25 mm) from the cheek. However, wire on the sway bars (above the bars and attaching to the spade) of a traditional spade bit is acceptable. They may be inlaid, but must be smooth or latex wrapped. Nothing may protrude below the mouthpiece (bar), such as extensions or prongs, including upward prongs on solid mouthpieces. The mouthpiece may be two or three pieces. A three-piece, connecting ring of 1 1/4" (32 mm) or less in diameter, or a connecting flat bar of 3/8" to 3/4" (10mm to 20 mm) measured top to bottom with a maximum length of 2" (50 mm), which lies flat in the horse's mouth, is acceptable;

SHW305.4.3 the port must be no higher than 3 1/2" (90 mm) maximum, with rollers and covers acceptable. Broken mouthpieces, halfbreeds and spades are standard;

SHW305.4.4 donut and flat polo mouthpieces are not acceptable;

SHW305.4.5 a curb bit must be used with a curb strap

or curb chain properly attached so as to make contact with horse's chin;

SHW305.4.6 slip or gag bit is permitted in speed events

SHW305.5 Except for hackamore/snaffle bit classes or junior horses shown with hackamore/snaffle bit, only one hand may be used on the reins, and the hand must not be changed. The hand is to be around the reins; index finger only between split reins is permitted. In trail, it is permissible to change hands to work an obstacle. Violation of this rule is an automatic disqualification.

SHW305.6 Romal means an extension of braided or round material attached to closed reins. This extension shall be carried in the free hand with a 16-inch (40 cm) spacing between the reining hand and the free hand holding the romal. When using romal reins, the rider's hand shall be around the reins with the wrists kept straight and relaxed, the thumb on top and the fingers closed lightly around the reins. When using a romal, no fingers between the reins are allowed. The free hand may not be used to adjust the rider's length of rein in any reining class. During reining, the use of the free hand while holding the romal to alter the tension or length of the reins from the bridle to the reining hand is considered to be the use of two hands and a score of 0 will be applied, with the exception of any place a horse is allowed to be completely stopped during a pattern. In all other classes, including the reined portion of working cow horse, the free hand may be used to adjust the rider's length of rein.

SHW305.6.1 The romal shall not be used forward of the cinch or to signal or cue the horse in any way. Any infraction of this rule shall be penalized severely by the judge.

SHW305.7 Junior horses competing in junior western pleasure, western horsemanship, reining, working cow horse, boxing, ranch horse riding, western riding and trail that are shown with a hackamore or snaffle bit may be ridden with one or two hands on the reins. The tails of the reins must be crossed on the opposite side of the neck when riding with two hands on split reins except in working cow horse, boxing and reining. Closed reins (example mecate) may not be used with a snaffle bit, except in versatility ranch horse, boxing, ranch horse riding, working cow horse and reining, where a mecate is permitted.

SHW305.8 In all western classes, horses will be shown in a western saddle and appropriate bridle, snaffle bit or hackamore for the duration of the class. A western saddle is a common type of saddle distinguished by a large noticeable fork on which there is some form of horn, a high cantle and large skirts. Silver equipment will not count over a good working outfit. Horses 5-years-old and younger may be shown in a snaffle bit, hackamore, curb bit, half-breed or spade bit. Horses 6-years-old and older may only be shown in a curb bit, half-breed or spade bit. Split reins or romal reins must be used on a curb bit except speed events, team penning, ranch sorting, roping and cowboy mounted shooting where they are optional. When a curb bit is used, a curb strap or curb chain is required, but must meet the approval of the judge, be at least one-half inch in width and lie flat against the jaw of the horse. Curb chains cannot be tied to the bit with string or cord. A broken strap or chain is not necessarily cause for disqualification.

SHW305.8.1 The use of two-rein equipment is allowed in

ACCEPTABLE ENGLISH BITS FOR ALL AGES

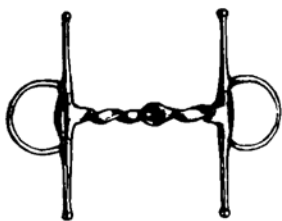

SLOW TWIST

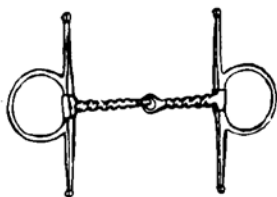

CORKSCREW

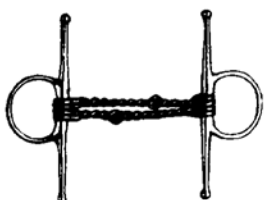

**DOUBLE TWISTED
WIRE**

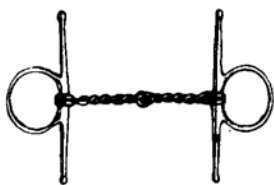

**SINGLE TWISTED
WIRE**

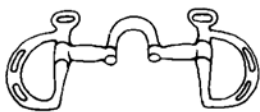

CORRECTION BIT



**SNAFFLE BIT WITH
CONNECTING FLAT BAR**

UNACCEPTABLE ENGLISH BITS

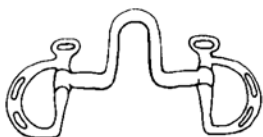

EXCESSIVE PORT

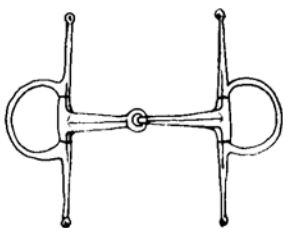

TRIANGULAR MOUTH

working cow horse, versatility ranch horse ranch cow work, VRH limited ranch cow work, and boxing classes only. For further clarification on the use of two-rein equipment, see SHW509.1.6-509.1.7.

SHW305.8.2 Any horse of any age shown in any Rookie/ Level I youth, Rookie/ Level I amateur or Level I class may be shown two handed with a snaffle bit/hackamore.

SHW305.9 SPEED EVENT, TEAM PENNING, RANCH SORTING, ROPING AND COWBOY MOUNTED SHOOTING EQUIPMENT:

SHW305.9.1 In roping, speed events, team penning and ranch sorting and cowboy mounted shooting western - type equipment must be used. Use of rawhide or mechanical hackamores or other type of bridles is the optional choice of the contestant. However, mechanical hackamore nosepieces must be covered in leather and cannot have visible or bare metal in contact with the horse's head. The judge or steward may prohibit the use of any bit or equipment they consider inhumane or would tend to give a horse/rider an unfair advantage.

SHW305.9.2 Tie-downs, used for roping, speed events and team penning, ranch sorting, and cowboy mounted shooting must be leather, flat nylon or rope a minimum of 3/8 inch in diameter.

SHW305.9.3 Bonnets (tie-down that goes over the poll and/ or across the forehead) made of rope, flat nylon webbing or leather only (minimum 3/8 inch diameter) are permitted.

SHW305.9.4 Martingales and draw reins are permitted for speed events, team penning, ranch sorting and cowboy mounted shooting. However, martingales used with curb bits must have rein stops. Draw reins may not be attached between or around the front legs.

SHW306. WESTERN: OPTIONAL EQUIPMENT

SHW306.1 Rope or riata; if used, the rope or riata must be coiled and attached to the saddle.

SHW306.2 Hobbles attached to saddle.

SHW306.3 Tapaderos, except in working cow horse where they are not allowed.

SHW306.4 Protective boots, leg wraps and bandages are allowed in reining, working cow horse, team penning, barrel racing, pole bending, stake racing, jumping, tie-down roping, break-away roping, dally team roping - heading, dally team roping - heeling, cutting, western horsemanship, ranch horse riding, versatility ranch horse, ranch riding and ranch trail. The use of slip on (easy care) horse boots or related footwear are not considered as protective boots and are permissible to be worn in all classes.

SHW306.5 Spurs; not to be used forward of the cinch.

SHW307. WESTERN PROHIBITED EQUIPMENT

SHW307.1 Protective boots, leg wraps and bandages are prohibited in western pleasure, trail, halter, western riding and showmanship.

SHW307.2 Wire curb straps, regardless of how padded or covered, or curb strap with tacks/rivets.

SHW307.3 Any curb strap narrower than one-half inch.

SHW307.4 Chain, wire, or metal tie-down or bonnets are prohibited, regardless of how padded or wrapped.

SHW307.5 Saw tooth bits; hock hobbles; tack collars; tack curb staps or tack hackamores; whips used for showmanship; war bridles or like devices; riding in a curb bit without a curb strap; wire or solid metal curb straps no matter how padded; wire cavesson; wire or cable tie-downs; bumper bits; metal bosals (no matter how padded); chambons; headstalls made of metal (no matter how wrapped or padded), twisted rawhide, or rope may not be used on a horse's head (3/8 inch rope may be used with a slip/gag bit or a bonnet); running martingales used with curb bits used without rein stops; draw reins attached between or around the front legs will not be allowed at AQHA-approved events.

SHW307.6 Jerk lines for roping.

SHW307.7 Tack collars for roping.

SHW307.8 Tie-downs may not have a built in cavesson or noseband.

SHW307.9 Fenders may not be connected by string or any other material

SHW310. ENGLISH EQUIPMENT. In all English classes, an English snaffle (no shank), kimberwick, pelham and/or full bridle (with two reins), all with cavesson nosebands and plain leather brow bands must be used.

SHW310.1 In reference to mouthpieces, nothing may protrude below the mouthpiece (bar). Solid and broken mouthpieces must be between 5/16" to 3/4" (8 mm to 20 mm) in diameter, measured 1" (25 mm) from the cheek and may have a port no higher than 1 1/2" (40 mm). They may be inlaid, synthetic wrapped, including rubber or plastic or incased, but must be smooth. On broken mouthpieces only, connecting rings of 1 1/4" (32 mm) or less in diameter or connecting flat bar of 3/8" to 3/4" (10 mm to 20 mm) measured top to bottom with a maximum length of 2" (50 mm), which lie flat in the horse's mouth, are acceptable. Snaffle bit rings may be no larger than 4" (100 mm) in diameter. Any bit having a fixed rein requires use of a curb chain. Smooth round, oval or egg-shaped, slow twist, corkscrew, single twisted wire, double twisted wire mouthpieces and straight bar or solid mouthpieces are allowed.

SHW310.2 In the jumping class only, mechanical hackamores may be used.

SHW310.3 Saddles must be black and/or brown leather of traditional hunting or forward seat type, knee insert on the skirt is optional. Saddle pads should fit size and shape, except when necessary to accommodate numbers on both sides, for which a square pad or suitable attachment may be used. Saddle pads and attachments shall be white or natural color with no ornamentation.

SHW311. ENGLISH OPTIONAL EQUIPMENT

SHW311.1 Spurs of the unrowelled type that are blunt, round or that include a smooth rolling rubber ball and no longer than one inch

SHW311.2 Crops or bats

SHW311.3 Gloves

SHW311.4 English breast plate

SHW311.5 Braiding of mane and/or tail in hunt style

SHW311.6 Standing or running martingales in working hunter, jumping and equitation over fences only

SHW311.7 Protective boots, leg wraps and bandages are allowed in hunt seat equitation on the flat and hunt seat equitation over fences.

SHW311.8 Colored saddle pads or pads with AQHA's corporate logo can be used on saddle pad in jumping only.

SHW311.9 Half Chaps, must be smooth brown or black leather

SHW312. ENGLISH PROHIBITED EQUIPMENT

SHW312.1 Bits of any style (pelham, snaffle, kimberwick) featuring mouthpieces with cathedrals, donuts, prongs, edges or rough, sharp material shall be cause for elimination. Square stock, metal wrapped or polo bits shall be cause for elimination. If a curb bit is used, the curb chain must be at least 1/2" (15mm) in width and lie flat against the jaw of the horse.

SHW312.2 Draw reins

SHW312.3 Rowelled spurs

SHW312.4 Standing or running martingales except in working hunter, jumping and equitation over fences

SHW312.5 Figure 8 or flash cavessons except in jumping

SHW312.6 Protective boots, leg wraps and bandages are prohibited in pleasure driving, hunter under saddle and boots of any description (except outdoors during inclement weather) in hunter hack, green working hunter and working hunter. The use of slip on (easy care) horse boots or related footwear are not considered as protective boots and are permissible to be worn in all classes.

SHW312.7 Rubber reins (except jumping)

SHW312.8 Slip on spurs

SHW313. PLEASURE DRIVING EQUIPMENT.

SHW313.1 Shall include a whip suitable to the cart, light horse breast collar harness to include surcingle with shaft tie-downs and crupper, standard bridle, overcheck or check reins. Only traditional driving bits: half cheek snaffle, liverpool, elbow driving bit and Bradoon overcheck bits are acceptable. Mouthpieces must be of the same dimensions as required in SHW310.1. If a curb chain is used, it must be at least 1/2" (15 mm) in width, and be flat against the jaw of the horse. The exhibitor shall be the only person permitted in such cart while the horse is being exhibited, and no pets shall be allowed in such cart during such exhibition. The cart shall be a pleasure-type two-wheel single horse cart with seats for one or two persons. All carts must be basket-type, equipped with 24-inch (60 cm) through 48-inch (1.2 meters) cart wheels. No stirrup-type carts or sulkies will be allowed. Dash and basket cover optional.

SHW314. PLEASURE DRIVING OPTIONAL EQUIPMENT

SHW314.1 Blinders

SHW314.2 Breeching, shaft keepers or thimbles

SHW314.3 Running martingales

SHW314.4 Cavesson nosebands

SHW315. PLEASURE DRIVING PROHIBITED EQUIPMENT

SHW315.1 Wire chin straps, regardless of how padded or covered

SHW315.2 Excessive ornamentation on harness, bridle or cart shall be penalized.

SHW320. ATTIRE

SHW320.1 In halter, speed events, team penning and other western classes, appropriate western attire is required which includes pants (slacks, trousers, jeans, etc.) long sleeves and collar (band, standup, tuxedo, etc.) western hat and cowboy boots. Special exception because of religious reasons or physical handicap must be requested by filing a written request to AQHA and obtaining written approval prior to participation. It is optional that an exhibitor may wear a hard hat with harness in all classes. The hat must be on the rider's head when the exhibitor enters the arena. At show management's option, a fine may be imposed to an exhibitor for loss of hat. Spurs and chaps are optional. In youth, Level I youth and open division speed events, exhibitors 18 years of age or under may use a rubber band per foot (maximum width of 1/4 inch) during competition, but may not be tied, buckled or fastened by any other means during competition.

SHW320.2 It is mandatory for riders in all hunter, jumper and equitation over fence classes, including hunter hack, where jumping is required and when jumping anywhere on the competition ground to wear properly fastened protective headgear that meets ASTM/SEI standards or equivalent international standards for equestrian use. The helmet must also be properly fitted with harness secured. It is mandatory that all youth wear a ASTM/SEI approved hard hat with harness during all English classes including flat and over fence classes. It is recommended that amateurs wear a ASTM/SEI approved hard hat with harness in all English classes.

SHW320.3 In all English classes, riders should wear hunt coats of traditional colors such as navy, dark green, grey, black or brown. Maroon and red are improper. Breeches are to be of traditional shades of buff, khaki, canary, light grey or rust (or jodhpurs), with high English boots or paddock (jodhpur) boots of black or brown. Black, navy blue or brown hard hat (with harness for youth in any over fence classes) is mandatory. A tie or choker is required. Gloves, spurs of the unrowelled type that are blunt, round or that include a smooth rolling ball and no longer than one inch and crops and bats are optional. Hair must be neat and contained (as in net or braid). Judges must penalize contestants who do not conform.

SHW320.4 In pleasure driving, the exhibitor shall be neatly attired. A coat, tie and hat of choice may be worn. No part of the exhibitor's legs may be exposed above mid-calf.

SHW320.5 Judges, at their discretion, may authorize adjustments to attire due to weather-related conditions.

SHW325. LAMENESS The judge shall examine and check for lameness of all horses brought into any class. The judge has the authority to excuse any horse from the class, due to lameness, at any time while being judged. This is essential regardless of whether or not the competition indicates it is necessary.

SHW325.1 Obvious lameness shall be cause for disqualification. Obvious lameness is:

SHW325.1.1 Consistently observable at a trot under all circumstances;

SHW325.1.2 Marked nodding, hitching or shortened stride;

SHW325.1.3 Minimal weight-bearing in motion and/or at rest and inability to move.

SHW330. GAITS - WESTERN CLASSES. The following terminology shall apply:

SHW330.1 The walk is a natural, flat-footed, four-beat gait. The horse must move straight and true at the walk. The walk must be alert, with a stride of reasonable length in keeping with the size of the horse.

SHW330.2 The jog is a smooth, ground-covering two-beat diagonal gait. The horse works from one pair of diagonals to the other pair. The jog should be square, balanced and with straight, forward movement of the feet. Horses walking with their back feet and trotting in the front are not considered performing the required gait. When asked to extend the jog, it moves out with the same smooth way of going.

SHW330.3 The lope is an easy, rhythmical three-beat gait. Horses moving to the left should lope on the left lead. Horses moving to the right should lope on the right lead. Horses traveling at a four-beat gait are not considered to be performing at a proper lope. The horse should lope with a natural stride and appear relaxed and smooth. It should be ridden at a speed that is a natural way of going. The head should be carried at an angle which is natural and suitable to the horse's conformation at all gaits.

SHW330.4 There will be an order of priority for evaluating western gaits. This hierarchy of consideration must be adhered to by judges and will be a great aid to exhibitors for how their horses should be presented. Following are the requirements in order of importance.

SHW330.4.1 Correctness-Concerning correctness, which is the most important element of the hierarchy, judges must assess if the exhibitor has performed each gait correctly as defined during all or the majority of all of the class in order to have a correct or positive evaluation. For western gaits, this includes a four-beat walk, two-beat jog and three-beat lope. The distinctness of the designated cadence for the gait being performed is essential.

SHW330.4.2 Quality-Concerning quality, which is the second most important element in the hierarchy, and can only be considered positively if the gait performance has complied with the first element of correctness. When evaluating the pleasing characteristics of a gait, among many considerations, judges must consider overall gracefulness, relaxed expression, topline, softness of movement, consistency and length of stride of the designated gait.

SHW330.4.3 Degree of Difficulty-Concerning degree of difficulty, this is the least important and last element of the hierarchy. This element must only be considered if the requirement for correctness has been met and combination of correctness and quality allow the performance to

be considered for placement. Difficulty is greatly influenced by exhibiting a pleasure horse at a pace and speed that allows for correctness and best quality of a gait for that individual. A performance of a walk that is ground covering and free flowing has a high degree of difficulty. A jog or lope that is performed with a slow rhythm without sacrificing correctness or quality has a high degree of difficulty. Slowness that sacrifices correctness or negatively impacts quality shall be considered incorrect and a poor performance at best.

SHW331. GAITS - WESTERN PLEASURE. The following terminology is a description of western pleasure gaits:

SHW331.1 The Walk

SHW331.1.1 Poor walk - uneven pace and no cadence. Has no flow and may appear intimidated or appear to march.

SHW331.1.2 Average walk - has a four-beat gait, level top-line and is relaxed.

SHW331.1.3 Good walk - has a flowing four-beat gait, level top-line, relaxed and is bright and attentive.

SHW331.2 The Jog

SHW331.2.1 Extremely poor jog - cannot perform a two-beat gait and has no flow or balance in the motion.

SHW331.2.2 Very poor jog - hesitates in the motion. Does not keep an even and balanced motion or a level top-line. May appear to shuffle.

SHW331.2.3 Poor jog - average motion but has negative characteristics such as; walking with the hind legs, dragging the rear toes or taking an uneven length of stride with the front and rear legs.

SHW331.2.4 Correct or average jog - has a two-beat gait, a level top-line and a relaxed appearance.

SHW331.2.5 Good jog - has an average motion with positive characteristics such as balance and self-carriage while taking the same length of stride with the front and rear legs.

SHW331.2.6 Very good jog - is comfortable to ride while having a consistent two-beat gait. The horse guides well, appears relaxed and has a level top-line.

SHW331.2.7 Excellent jog - effortless and very efficient motion. Swings the legs yet touches the ground softly. Confident, yet soft with its motion while being balanced and under control. Moves flat with the knee and hock and has some cushion in the pastern. Has a bright and alert expression and exhibits more lift and self-carriage than the "very good jog".

SHW331.3 Moderate Extended Jog

SHW331.3.1 Poor extended jog - never lengthens the stride and may appear rough to ride.

SHW331.3.2 Average extended jog - moves up in its pace and appears smooth to ride.

SHW331.3.3 Good extended jog - has an obvious lengthening of stride with a slight increase in pace while exerting less effort and appears smooth to ride.

SHW331.4 The Lope

SHW331.4.1 Extremely poor lope - does not have a three-beat gait. Has no flow, rhythm or balance. Uncomfortable to ride.

SHW331.4.2 Very poor lope - appears to have a three-beat lope but has no lift or self-carriage. The horse shuffles, has no flow and bobs his head, giving the appearance of exerting a great deal of effort to perform the gait. Also may appear uncomfortable to ride.

SHW331.4.3 Poor lope - has an average motion but exhibits negative characteristics like head bobbing, not completing the stride with the front leg and leaving the outside hock well behind the horse's buttocks.

SHW331.4.4 Average lope - has a true three-beat gait with a level top-line and very little head and neck motion. He is relatively straight (not over-canted), guides well and has a relaxed appearance.

SHW331.4.5 Good lope - has an average motion but exhibits positive characteristics in his performance like self-carriage, a steady top-line, relaxed appearance and is responsive to the rider's aids.

SHW331.4.6 Very good lope - has more lift and flow than the average horse. He has a strong but smooth drive from behind. He may bend his knee slightly yet still has a level top-line while exhibiting self-carriage with a relaxed appearance. Appears comfortable to ride.

SHW331.4.7 Excellent lope - has a round back with an effortless strong, deep stride with the rear legs and a flat swing with the front legs. He keeps a level top-line, a relaxed yet alert and confident appearance and is correct but soft. A special horse with a great degree of lift and self-carriage.

SHW331.5 The Back-Up

SHW331.5.1. Poor back-up - is resistant and heavy in front. May gap the mouth and throw his head or back crooked.

SHW331.5.2 Average back-up - backs straight and quietly with light contact and without hesitation.

SHW331.5.3 Good back-up - displays balanced and smooth flowing movements. Backs straight with self-carriage without gapping the mouth with light contact and without hesitation.

SHW332. GAITS - ENGLISH CLASSES. The following terminology shall apply:

SHW332.1 The Walk

SHW332.1.1 Poor Walk - This horse may have an uneven pace that lacks a four beat cadence or have a stop and start or robotic appearance that resembles a march. He may appear nervous and on the muscle or intimidated and fearful of going forward. He may anticipate or try to jog or break or he may appear dull, bored and listless dragging his legs and losing rhythm and flow.

SHW332.1.2 Average Walk - The horse will walk with a four beat gait, a balanced top line and a relaxed appearance. He may slow down some but still maintains forward motion. He keeps his body straight and has cadence and

rhythm. All of this done correctly and with manners is average.

SHW332.1.3 Good Walk - This horse has a four beat gait, a balanced and comfortable top line, relaxed demeanor and appears bright and attentive. He maintains rhythm, flow and cadence and travels straight with light contact from the reins. He reaches from his shoulder and tracks up from behind with his reaching legs staying close to the ground. His feet enter the ground softly and maintain the same pace coming out of the ground as he has going into it.

SHW332.2 The Trot

SHW332.2.1 Extremely Poor Trot - This is a horse that cannot seem to do a two beat gait and appears very uncomfortable in his attempt to accomplish it. He does not have any flow or balance in his motion and appears uncomfortable to ride. He may be weak and sloppy in his hocks causing a loss of forward motion or use his hocks loosely or too far back causing a loss of cadence and rhythm. This also could be a horse that is misbehaving and is unwilling to perform the gait properly and therefore is not exhibiting acceptable motion.

SHW332.2.2 Very Poor Trot - This is a horse that may have an uneven cadence or be unwilling to go forward. He may not keep an even and balanced motion with a level top line. This horse may appear quick legged or seem to move in an up and down fashion or may be on the muscle looking nervous and tense or he may be on a loose and sloppy rein causing a lack of collection or to travel heavy on the forehand. He may cover the ground by taking more frequent steps instead of correctly increasing the length of the strides.

SHW332.2.3 Poor Trot - This is a horse with an average motion, exhibiting negative characteristics in their performance. For example, this horse may have an average trot gait but have a dull, unhappy or resentful expression.

SHW332.2.4 Correct or Average Trot - This horse has a two beat diagonal gait in which the left front and right hind foot touch the ground simultaneously and the right front and left hind do so also. This is the standard trot and a horse **MUST** have a true two beat gait to be "average" or any of the levels higher than "average". He has a level top line, with a relaxed appearance and pleasant expression, is shown on light contact and appears to go in a forward, obedient manner.

SHW332.2.5 Good Trot - This is a horse with an average motion, exhibiting positive characteristics in their performance. For example this horse may have an average trot gait but have excellent manners and expression with ears forward and appearing bright but relaxed and calm.

SHW332.2.6 Very Good Trot - This is a horse that appears very comfortable to ride, always has a consistent rhythmic cadenced two beat gait, is guiding well and has a relaxed and level top line. He has a good forward stride with balance and impulsion. Compared to the excellent horse he may not have as much stride as he may not have

the degree of drive off the hindquarters or as much reach with his shoulders. He may bend his knees or flex his pasterns a little but he is still obviously soft, smooth and relaxed. He has an attentive and calm appearance with a pleasant expression and maintains light bit contact.

SHW332.2.7 Excellent Trot - This horse's motions seem effortless and efficient. He utilizes his top line by rounding his back and driving evenly off his hind legs creating impulsion and suspension while still remaining soft and controlled. He takes long ground covering steps with deliberate full strides and stays close to the ground. He reaches from his shoulder and is flat with his knee and extends his leg forward and seems to enter the ground toe first, even though it actually lands flat. His drive from his hocks allows his hind leg to step into or in front of where his front foot left the ground using full extension of the stride. This horse is balanced, has a level top line and has an even rhythm and cadence. He has excellent manners and great expression appearing relaxed and happy, soft in his poll, jaw and mouth and is shown on light contact.

SHW332.3 The Extended Trot

SHW332.3.1 Poor Extended Trot - This horse never appears to lengthen his stride but just trots faster. He may also appear to be jarring and rough to ride.

SHW332.3.2 Average Extended Trot - Is a horse who when asked to extend, moves up in his pace and still appears smooth to post on.

SHW332.3.3 Good Extended Trot - Is a horse who when asked to extend has an obvious lengthening in his stride with a slight increase in his pace making him more versatile. This horse is still smooth but appears to have more length with less effort being exerted.

SHW332.4 The Canter

SHW332.4.1 Extremely Poor Canter - This is a horse that does not have a true three beat gait. He has no cadence, no rhythm, and no balance, appears out of sync and obviously is not comfortable to ride. This may also be a horse that is misbehaving and unwilling to perform the gait properly and therefore is not exhibiting acceptable motion.

SHW332.4.2 Very Poor Canter - This is a horse that may appear to have a three beat gait but lacks self carriage. He may be flat in that he has either not rounded his back, or failed to engage his hindquarters and therefore lacks drive, impulsion and suspension. He may be weak hocked causing him to pull himself forward with his front end or he may not be balancing off his hindquarters causing him to be heavy on his forehand. This horse may lack forward motion, smoothness of gait, or consistency of speed. He may not use his shoulders properly causing excessive knee action. He may be showing on loose reins and be strung out and lacking collection or be nervous and on the muscle causing a shortening or quickening of stride.

SW332.4.3 Poor Canter - This is a horse with an average motion, exhibiting negative characteristics in his performance. For example, this horse may have an average canter but be lacking in expression or lack consistency in his

top line.

SHW332.4.4 Correct Or Average Canter - This horse has a true three beat gait with a level top line, and a comfortable motion. This is the standard canter and a horse **MUST** have a true three beat gait to be considered "average" or any of the levels higher than "average". He is shown on light contact and is responsive to his rider and has a relaxed appearance with a pleasant expression.

SHW332.4.5 Good Canter - This is a horse with an average motion, exhibiting positive characteristics in his performance. For example, this may be a horse with an average canter gait but has great expression, consistency and lovely manners.

SHW332.4.6 Very Good Canter - This is a horse that has more style, drive, impulsion and suspension than the average horse. He has a strong but smooth drive from behind. He may bend his knee a little or not have quite the length of stride of the excellent horse, yet he still has a level top line and relaxed appearance, is correct and appears to be comfortable to ride. He has a pleasant expression and is responsive to his rider and shown with light bit contact.

SHW332.4.7 Excellent Canter - This is a horse that utilizes his top line by rounding his back, engaging his hindquarters to drive his hind legs deep underneath him creating impulsion and suspension in his motion. He has a strong, deep, forward stride behind and an equally forward, flat-kneed reach with his front legs. He appears effortless and totally in control of his motion with great self carriage. He creates energy yet stays soft and responsive to his rider. His weight is distributed properly onto his hindquarters and he moves with long, slow strides. He gives the appearance that, if asked, he could easily lengthen his stride and correctly perform a hand gallop. This horse has a great degree of suspension, impulsion and elasticity to his movement. He has great expression with ears forward and is consistent, relaxed and confident with light bit contact.

SHW332.4.8 Hand Gallop - should be a definite lengthening of stride with noticeable difference in speed. Horses should be under control at all times and be able to pull-up (not a sliding stop). If asked to pull-up, after the halt, riders must relax the reins and the horse must stand quietly.

SHW333. GAITS - PLEASURE DRIVING. The following terminology shall apply:

SHW333.1 Walk - a natural, flat-footed, four-beat gait. Loss of forward rhythmic movement shall be penalized.

SHW333.2 Park gait - a forward, free-flowing, square trot with impulsion. Loss of forward, rhythmic movement or jogging shall be penalized.

SHW333.3 Road gait - an extended trot showing a definite lengthening of stride, with a noticeable difference in speed. Short, quick, animated strides and/or excessive speed shall be penalized.

SHW334 GAITS-RANCH RIDING. In all gaits, movement of the ranch riding horse should simulate a horse needing to cover

long distances, softly and quietly, like that of a working ranch horse. The following terminology shall apply:

SHW334.1 Walk-The walk is a natural, flat footed, four-beat gait. The gait is rhythmic and ground-covering. As in all gaits, the horse should display a level, or slightly above level topline with a bright, attentive expression.

SHW334.2 Trot- The trot is a natural two-beat gait demonstrating more forward motion than the western jog.

SHW334.3 Extended Trot- The extended trot is an obvious lengthening of the stride with a definite increase in pace. The horse should be moving in a manner as if it were covering a large area on a ranch with an above level topline.

SHW334.4 Lope- The lope is a three-beat gait The lope should be relaxed and smooth with a natural, forward moving stride.

SHW334.5 Extended Lope- The extended lope is not a run or a race but should be an obvious lengthening of the stride, demonstrating a forward, working speed. The horse should display an above level topline with a bright, attentive expression.

SHW350. HALTER CLASSES. A halter class is defined as a class where the horse is judged based upon its conformation. The purpose of the class is to preserve American Quarter Horse type by selecting well-mannered individuals in the order of their resemblance to the breed ideal and that are the most positive combination of balance, structural correctness, and movement with appropriate breed and sex characteristics and adequate muscling.

SHW350.1 The ideal American Quarter Horse shown at halter is a horse that is generally considered to be solid in color and possesses the following characteristics: the horse should possess eye appeal that is the result of a harmonious blending of an attractive head; refined throat latch; well-proportioned, trim neck; long, sloping shoulder; deep heart girth; short back; strong loin and coupling; long hip and croup; and well-defined and muscular stifle, gaskin, forearm and chest. All stallions 2 years old and over shall have two visible testicles. These characteristics should be coupled with straight and structurally correct legs and feet that are free of blemishes. The horse should be a balanced athlete that is muscled uniformly throughout.

SHW350.2 All horses whose registration certificates are marked with a parrot mouth notation per registration rules, cryptorchid notation per registration rules or excessive white notation per registration rules are ineligible to compete in any halter class including performance halter.

SHW350.3 One of the most important criteria in selecting a horse is conformation, or its physical appearance. While it could be assumed that most horses with several years' seasoning and past performance have acceptable conformation, the goal in selection should always be to find the best conformed horse possible.

SHW350.4 Rating conformation depends upon objective evaluation of the following four traits: balance, structural correctness, breed and sex characteristics, and degree of muscling. Of the four, balance is the single most important, and refers to the structural and aesthetic blending of body parts. Balance is influenced almost entirely by skeletal structure.

SHW351. GROUP HALTER CLASSES. Horses shown in a group class must be eligible to show in their individual halter class. The following classes are recommended if interest or entries justify them, but no points will be awarded for Register of Merit or Championship:

SHW351.1 Produce of Dam: Two produce, 4 years old and younger of either sex, per dam, may be shown. The dam need not be shown. The entry at the show must be made by the owner of the dam or by someone with written permission from the owner of the dam, but it is unnecessary for the produce to be owned by the owner of the dam.

SHW351.2 Get of Sire: Three get, 4 years old and younger of either sex, per sire, may be shown. The sire need not be shown. The entry at the show must be made by the owner of the sire or by someone with written permission from the owner of the sire, but it is unnecessary for the get to be owned by the owner of the sire.

SHW351.3 Broodmares. Mares that have produced and carried a full-term foal in the current year or the previous year. Mares may be any age. Mares shown in the broodmare class are not eligible to compete in any filly or mare class, nor is any mare shown in any filly or mare class eligible to compete in a broodmare class.

SHW355. Halter Equipment

SHW355.1 Applying excessive pressure on or excessive jerking of a halter lead shank or the use of any type of lip chain is prohibited.

SHW362 PROCEDURE FOR JUDGING HALTER. Horses will walk to the judge one at a time. As the horse approaches, the judge will step to the right (left of the horse) to enable the horse to trot straight to a cone placed 50 feet (15 meters) away. At the cone, the horse will continue trotting, turn to the left making a true "L" and trot toward the next cone placed before the left wall or fence of the arena. After trotting, horses will be lined up head to tail for individual inspection by the judge. The judge shall inspect each horse from both sides, front and rear.

SHW362.1 At single judged shows, the judge should line the horses to be placed in a head to tail order according to preference.

SHW362.2 A well-mannered horse is a horse that (1) is under control by the exhibitor while tracking and standing for inspection and (2) is reasonably still and flat-footed while standing for inspection.

SHW362.3 For purposes of this rule, the term "disruptive behavior" includes, but is not limited to rearing, striking, biting, or backing or falling into others.

SHW362.4 Judges should disqualify and excuse from the ring prior to final placing a horse that:

SHW362.4.1 exhibits disruptive behavior such that it or other horses are unable to be inspected by the judge;

SHW362.4.2 exhibits disruptive behavior such that the safety of it, the handler, an exhibitor, a judge or another horse is endangered;

SHW362.4.3 is not under the control of the exhibitor;

SHW362.4.4 becomes detached from the exhibitor;

SHW362.4.5 has fallen and is on its side with all four

feet extended in the same direction;

SHW362.4.6 is observed with blood on its body, including, but not limited to, the nose, chin, mouth, tongue, or gums, regardless of cause;

SHW362.4.7 is lame.

SHW362.5 Rather than disqualify, a judge may choose to fault a horse that is exhibiting disruptive behavior so long as such disruptive behavior does not qualify as being any of the behaviors described immediately above in SHW362.4.1-5

SHW362.6 If a horse exhibits disruptive behavior described in SHW362.4.1-5 and causes other exhibitor(s) to lose their horse(s), only the initiating horse will be disqualified and excused. The decision of the judge(s) will be final.

SHW362.7 All stallions 2 years old and over shall be examined to confirm that they have two visible testicles. All mares and stallions shall be examined for parrot mouth. If examination reveals that a horse has parrot mouth or is cryptorchid, such horse should be excused from the ring prior to final placing by the judge regardless of whether the parrot mouth or cryptorchid condition is marked on the horse's registration certificate.

SHW362.8 A horse may be exhibited in only one point-earning open division halter class.

SHW362.9 In no individual halter classes may horses from two sex divisions be exhibited in the same class.

SHW362.10 Spayed mares may be shown only in performance halter and ranch horse conformation classes, and may not be shown in any other halter class and are not eligible for grand and reserve.

SHW365. PERFORMANCE HALTER. The performance halter class is required in the open, amateur and youth divisions when halter classes are offered. Only an all-age class will be held. Separate classes will be held for stallions, mares and geldings in the open and amateur divisions. Separate classes will be held for mares and geldings in the youth division.

SHW365.1 First and second place in the performance halter class will be eligible for Grand and Reserve in each sex division. The number of entries in the performance halter class count toward the total for each sex division in determining points for Grand and Reserve. First place performance horse will be named Champion Performance Halter in classes with five or more entries.

SHW365.2 For purposes of this rule, the term "AQHA Performance Points" includes points earned in any class outlined in ACHIEVEMENT AWARDS other than halter and racing.

SHW365.3 The following horses are the only horses eligible to compete in the performance halter class:

SHW365.3.1 horses that have earned a Racing Register of Merit;

SHW365.3.2 horses that have earned a Performance Register of Merit prior to January 1, 2010; and

SHW365.3.3 horses that earn a Performance Register of Merit after January 1, 2010 so long as their record reflects that they have earned at least 5 or more AQHA Performance Points during their career in competitions other than Showmanship At Halter. i.e. A horse earns a

Performance Register of Merit prior to January 1, 2010. The 10 points earned to achieve the Performance Register of Merit consist of 6 Showmanship at Halter points and 4 Western Pleasure points; the horse is eligible to compete in a performance halter class. i.e. a horse earns a Performance Register of Merit after January 1, 2010. The 10 points earned to achieve the Performance Register of Merit consist of 6 Showmanship at Halter points and 4 Western Pleasure points; the horse must earn one more AQHA Performance Point in a class other than Showmanship at Halter to be eligible to compete in a performance halter class.

SHW365.4 For purposes of this rule, a Register of Merit or AQHA Performance Point is considered “earned” only after the Register of Merit or AQHA Performance Point has been officially recorded in AQHA’s records.

SHW365.5 Proof that a horse meets the eligibility requirements specified above must be provided to show management.

SHW365.6 The Register of Merit applies to the horse. If the horse is transferred, the horse is eligible to compete in performance halter with the new owner so long as the horse meets the eligibility requirements specified above.

SHW365.7 A horse may not show in the age division halter class and the performance halter class at the same show in a particular division.

SHW369. GRAND AND RESERVE CHAMPION. When judging of all classes in a halter division has been completed, all first and second-place class winners of that sex division, with the exception of spayed mares, shall return to the ring, with first-place class winners in one line and second-place horses from each class in another line.

SHW369.1 It is mandatory that the judge select a Grand Champion and Reserve Champion in each sex division in open, youth and amateur divisions having three or more entries.

SHW369.2 The judge(s) shall select the Grand Champion stallion, mare or gelding from the first-place class winners in the respective sex division. If the first-place horse does not return for any reason, the second-place horse will move up to the first-place line and be considered for Grand and Reserve. The third-place horse cannot move up to second place in the class. All first-place horses will retain points in their respective class.

SHW369.3 The ring steward shall take the second-place horse in the class from which the Grand Champion had been selected and place it in the line with the first-place class winners, to be judged equally for the title of Reserve Champion stallion, mare or gelding in the respective sex division.

SHW369.4 In amateur halter or youth competition, when an exhibitor has qualified two or more horses for Grand and Reserve Champion, only another amateur or youth may assist that exhibitor as long as the amateur or youth who originally qualified the horses leads one of the horses in that class. An amateur cannot lead a non-owned horse in the open division for Grand and/or Reserve Champion.

SHW370. SHOWMANSHIP AT HALTER. Available only in the amateur and youth divisions, showmanship is designed to

evaluate the exhibitor's ability to execute, in concert with a well groomed and conditioned horse, a set of maneuvers prescribed by the judge with precision and smoothness while exhibiting poise and confidence, and maintaining a balanced, functional and fundamentally correct body position.

SHW370.I It is mandatory that the judge post the initial pattern to be worked at least one hour prior to the commencement of the class; however, if the judge requires additional work of exhibitors for consideration of final placing, an additional pattern may be posted. Pattern(s) should be designed to test the showman's ability to effectively present a horse to the judge. All ties will be broken at the judge's discretion.

SHW371. CLASS PROCEDURES: All exhibitors may enter the ring and then work individually or each exhibitor may be worked from the gate individually. When exhibitors are worked individually from the gate, a working order is required. The following maneuvers are considered acceptable: lead the horse at a walk, jog, trot or extended trot, or back in a straight or curved line, or a combination of straight and curved lines; stop; and turn 90 (1/4), 180 (1/2), 270 (3/4), 360 (full turn) degrees or any combination or multiple of these turns. The pull turn is an unacceptable maneuver. The judge must have exhibitors set the horse up squarely for inspection sometime during the class.

SHW372. Showmanship whips (dressage whips etc.), war bridles or like devices or any type of wire or rope over a horse's head are not permitted for showmanship purposes.

SHW372.I A minimum gauge link of 4.0 mm is required.

SHW373. SCORING: Exhibitors are to be scored from 0 to 100 with 70 denoting an average score. It is suggested a minimum score of 50 be administered except for disqualifications. One-half point increments are acceptable. Maneuver scores will be indicated as follows:

+ = Very Good

√+ = Good

√ = Correct

√- = Poor

- = Very Poor

An additional + (Excellent) or - (well below average) may be given.

SHW373.I FINAL SCORING shall be on a basis of 0-100, with an approximate breakdown as follows:

90-100 Excellent showmanship, including body position and presentation of horse. Completes pattern accurately, quickly, smoothly and precisely; demonstrates a high level of professionalism.

80-89 Very good performance in execution of the pattern as well as correct showmanship and presentation of horse. Excellent showman that commits a major fault.

70-79 Good pattern execution and average showmanship; lacking adequate style and professional presentation to merit elevating to the next scoring range. A very good showman that commits a major fault or an excellent showman that commits a severe fault.

60-69 Fair pattern that lacks quickness or precision. Horse with consistently unwilling attitude or handler with

obvious position and/or presentation faults that prevents effective showmanship. A good showman that commits one major fault in the performance of the pattern. A very good showman that commits a severe fault.

Less than 59 Good showman that commits one severe or multiple major and/or minor faults; excellent or very good showman that commits multiple, and/or combination of, severe, major or minor faults in the performance or presentation or position of exhibitor that precludes effective communication with the horse.

SHW374. Overall Presentation of Exhibitor and Horse.

The exhibitor's overall poise, confidence, appearance and position throughout the class, and the physical appearance of the horse will be evaluated.

SHW375. Presentation and Position of Exhibitor. Appropriate western attire must be worn; clothes and person are to be neat and clean. The use of any type of artificial aid including, but not limited to lighters, hay, dirt, sharp pins, etc. will be considered a disqualification.

SHW375.1 Exhibitors should be poised, confident, courteous and genuinely sportsmanlike at all times, quickly recognizing and correcting faults in the positioning of the horse. The exhibitor should continue showing the horse until the class has been placed or they have been excused, unless otherwise instructed by the judge. The exhibitor should appear business-like, stand and move in a straight, natural and upright manner, and avoid excessive, unnatural or animated body positions.

SHW375.2 The exhibitor must lead on the horse's left side holding the lead shank in the right hand near the halter with the tail of the lead loosely coiled in the left hand unless requested by the judge to show the horse's teeth. It is preferable that the exhibitor's hand not be on the snap or chain portion of the lead continuously. The excess lead should never be tightly coiled, rolled or folded. When leading, the exhibitor should be positioned between the eye and the mid-point of the horse's neck, referred to as the leading position.

SHW375.3 Both arms should be bent at the elbow with the elbows held close to the exhibitor's side and the forearms held in a natural position. Height of the arms may vary depending on the size of the horse and exhibitor, but the arms should never be held straight out with the elbows locked.

SHW375.4 The position of the exhibitor when executing a turn to the right is the same as the leading position except that the exhibitor should turn and face toward the horse's head and have the horse move away from them to the right.

SHW375.5 When executing a back, the exhibitor should turn from the leading position to face toward the rear of the horse with the right hand extended in front of the exhibitor's chest still maintaining slight bend in the elbow and walk forward. The ideal position is for the exhibitors left shoulder to be in alignment with the horse's left front leg.

SHW375.6 When setting the horse up for inspection, the exhibitor should stand angled toward the horse in a position between the horse's eye and muzzle, and should never leave the head of the horse. The exhibitor is required to use the Quarter Method when presenting the horse. The exhibitor should maintain

a position that is safe for themselves and the judge. The position of the exhibitor should not obstruct the judge's view of the horse and should allow the exhibitor to maintain awareness of the judge's position at all times. The exhibitor should not crowd other exhibitors when setting up side-by-side or head-to-tail. When moving around the horse, the exhibitor should change sides in front of the horse with minimal steps and should assume the same position on the right side of the horse that they had on the left side.

SHW375.7 Leading, backing, turning and initiating the set-up should be performed from the left side of the horse. At no time should the exhibitor ever stand directly in front of the horse. The exhibitor should not touch the horse with their hands or feet, or visibly cue the horse by pointing their feet at the horse during the set-up.

SHW376. Presentation of Horse. The horse's body condition and overall fitness should be assessed. The hair coat should be clean, well-brushed and in good condition. The mane, tail, forelock and wither tuft may not contain ornaments (ribbons, bows, etc.), but may be braided or banded for English or Western. The length of mane and tail may vary, as long as they are neat, clean and free of tangles. The mane should be even in length or may be roached, but the forelock and tuft over the withers must be left. The bridle path, eyebrows, and long hair on the head and legs may be clipped, except where government regulations prohibit. Hooves should be properly trimmed and if shod, the shoes should fit correctly and clinches should be neat. Hooves must be clean and may be painted black or with hoof dressings, or shown naturally. Tack should fit properly and be neat, clean and in good repair.

SHW377. Performance. The exhibitor should perform the work accurately, precisely, smoothly, and with a reasonable amount of speed. Increasing speed of the work increases the degree of difficulty, however, accuracy and precision should not be sacrificed for speed. The horse should lead, stop, back, turn and set up willingly, briskly and readily with minimal visible or audible cueing. Severe disobedience will not result in a disqualification but should be penalized severely, and the exhibitor should not place above an exhibitor that completes the pattern correctly. Excessive schooling or training, willful abuse, loss of control of the horse by the exhibitor, failure to follow prescribed pattern, knocking over or working on the wrong side of the cones shall be cause for disqualification.

SHW377.1 The horse should be led directly to and away from the judge in a straight or curved line and track briskly and freely at the prescribed gait as instructed. The horse's head and neck should be straight and in line with the body.

SHW377.2 The stop should be straight, prompt, smooth and responsive with the horse's body remaining straight.

SHW377.3 The horse should back up readily with the head, neck and body aligned in a straight or curved line as instructed.

SHW377.4 On turns of greater than 90 degrees, the ideal turn consists of the horse pivoting on the right hind leg while stepping across and in front of the right front leg with the left front leg. An exhibitor should not be penalized if their horse performs a pivot on the left hind leg, but an exhibitor whose horse per-

forms the pivot correctly should receive more credit.

SHW377.5 A pull turn to the left is an unacceptable maneuver.

SHW377.6 The horse should be set up quickly with the feet squarely underneath the body. The exhibitor does not have to reset a horse that stops square.

SHW378. FAULTS. Faults can be classified as minor, major or severe. The judge will determine the appropriate classification of a fault based upon the degree and/or frequency of the infraction.

SHW 378.1 Minor Faults, that have a deduction of 5 points, include:

- Break of gait at walk or trot for up to two strides
- Over or under turning up to 1/8 of a turn
- Ticking or hitting cone
- Sliding a pivot foot
- Lifting a pivot foot during a pivot or set-up and replacing it in the same place

SHW 378.2 Major Faults that have a deduction of 10 points, include:

- Not performing the gait or not stopping within 10 feet of designated area
- Break of gait at walk or trot for more than 2 strides
- Splitting the cone (Cone between the horse and handler)
- Horse stepping out of or moving the hind end significantly during a pivot or turn
- Horse stepping out of set-up after presentation
- Over/under turning 1/8 to 1/4 turn

SHW 378.3 Severe Faults have a deduction of 20 points. Severe faults avoid disqualification but should be placed below other exhibitors that do not incur a severe fault. They include:

- Exhibitor is not in the required position during inspection
- Exhibitor touching the horse or kicking or pointing their feet at the horse's feet during the set-up
- Standing directly in front of the horse
- Loss of lead shank, holding chain or two hands on shank
- Severe disobedience including rearing or pawing; horse continually circling exhibitor

SHW 379 Disqualifications (Should not be placed) include:

- Loss of control of horse that endangers exhibitor, other horses, or judge
- Horse becomes separated from exhibitor
- Failure to display correct number
- Willful abuse
- Never performing specific gait
- Excessive schooling or training; use of artificial aids
- Knocking over the cone or going off pattern
- Illegal equipment
- Over or under turning by more than 1/4 turn

SHW380. Rookie/Level I Classes Only. Exhibitor's going off pattern, knocking over or on wrong side of cone, never performing specified gait, or overturning more than 1/4 turn than designated, shall not be disqualified, but must always place below exhibitors not incurring a disqualifying fault.

SHW400. PERFORMANCE CLASSES. In open division competition, an exhibitor may enter one or more horses in a class, but each horse may have only one rider per class. In individual open division working events (ranch riding, reining, working cow horse, boxing, western riding, barrel racing, pole bending, jumping, working hunter, trail, tie-down roping, dally team roping - heading, dally team roping - heeling, team penning, ranch sorting and cutting) a rider may:

SHW400.1 Exhibit three horses in a junior class.

SHW400.2 Exhibit three horses in a senior class.

SHW400.3 Exhibit a maximum (total) of four horses in an all-age class. There is no stipulation on the combination of the junior horses and/or senior horses in an all age class. If a junior class and a senior class are combined due to a lack of entries (may only be combined if there are two or less entries in one or both of the junior and senior classes), that class will become an all-age class.

SHW400.4 In a leveled class that is run concurrent [Level 2 and Level 3], an exhibitor may show a maximum of four horses. If less than two entries in Level 2, entries will be combined with Level 3.

SHW400.5 In Level I youth, youth, Level I amateur, select amateur and amateur in individual working events, (ranch riding, reining, working cow horse, boxing, western riding, barrel racing, pole bending, stakes race, jumping, working hunter, trail, breakaway roping, tie-down roping, dally team roping - heading, dally team roping - heeling, team penning, ranch sorting and cutting) an exhibitor may show three horses regardless of sex (except youth, Level I youth and Level I amateur where stallions may not be exhibited).

SHW400.6 A Select exhibitor, in individual working events may show any combination in select and amateur as long as a maximum of three different horses are exhibited and that horse is only shown one time by any exhibitor in that class. For example, a select exhibitor in individual working events may exhibit all three horses in the amateur, all three horses in the select, two horses in select and one in amateur or one in select and two in amateur. A horse may only be exhibited one time in a class in either select or amateur no matter the exhibitor.

SHW400.7 A Select exhibitor in select amateur or amateur classes may show up to two different horses in group classes (showmanship at halter, western pleasure, western horsemanship, hunter under saddle, hunter hack, hunt seat equitation, equitation over fences and pleasure driving) as long as one horse is shown in the amateur group class and a different horse is shown in the select group class. Should the classes be combined, the select amateur must choose on which horse to compete.

SHW400.8 No horse may be shown in more than one youth or amateur subdivision of any type of event. (Example: A horse ridden in a reining class by a youth in the 11-year-old and younger group cannot also be ridden in a reining class by a youth in the 15-through 18-year-old group). However, the same horse may be shown in a Level I class then shown by another exhibitor or same exhibitor in Level 2 or 3 youth or amateur division.

SHW400.9 No exhibitor 18 years of age or under may be tied, buckled or fastened in the saddle in any manner (except as described in SHW320.1) or by any means during youth or Level I youth competition.

SHW400.10 If there is an elimination, each horse must be ridden in the actual class by the same rider who rode it in the elimination.

SHW400.11 Any horse used at an AQHA-approved show as a helping horse in cutting, heading and heeling must be an American Quarter Horse.

SHW400.12 Holding the saddle horn with either hand will be penalized and may be disqualified at the judge's discretion unless covered by specific class rules.

SHW400.13 allow exhibitors to roll over times in speed events. If an exhibitor is eligible to show in multiple classes, they may make one run and declare in advance that particular run will carry over or roll over to the other class(es) entered. This applies to Level I youth, youth, Level I amateur, amateur, and Select amateur exhibitors. The exhibitor must declare at time of entry if any times are to be rolled over and to which particular class(es). An entry fee and any additional charges will be paid for each class entered. An exhibitor may not declare to roll over a time once the classes have begun or have a time rolled over to any class that has already been held. They will make their run in the first class that they are entered according to the show schedule. They will be included in the draw for that class but are not to be placed in the draw for the upcoming class(es) they have declared so as not to affect the draw for those particular class(es). The announcer should also announce on the initial run whether or not the time is going to be rolled over to any subsequent class. If a show is being held where there are multiple judges, and the class is held one time then the time will be noted for each judge in the appropriate class(es) entered and declared. If the show is a circuit with multiple days, then an entry and declaration must be made for the separate show days. Once the class has started an exhibitor declaring a time will carryover cannot decide to run independently.

SHW401. LEVEL I WESTERN PLEASURE. The purpose of Level I western pleasure is to allow a horse to compete in a field with minimally accomplished horses of the same level of experience. The Level I western pleasure is a stepping-stone to the more advanced competition of Level 2/Level 3.

SHW401.1 Horses regardless of their age may be ridden with one hand and a standard western bit as approved by AQHA equipment rules or with two hands and a snaffle bit or bosal as described under AQHA equipment rules.

SHW401.2 With the exception of eligibility and equipment requirements, the same rules apply in Level I western pleasure as apply in western pleasure.

SHW401.3 Horses eligible to compete if they have not, as of January 1 of the current year:

SHW401.3.1 won 25 points or more in AQHA-approved western pleasure classes (horse points from all levels in any division will count including introductory/rookie points and are cumulative in determining eligibility); or

SHW401.3.2 won \$1,000 or more in any equine organization or association in western pleasure classes.

SHW401.3.3 Accuracy of eligibility is the responsibility of the owner or exhibitor.

SHW402. WESTERN PLEASURE. A good western pleasure horse has a free-flowing stride of reasonable length in keeping with his conformation. He should cover a reasonable amount of ground with little effort. Ideally, he should have a balanced, flowing motion, while exhibiting correct gaits that are of the proper cadence. The quality of the movement and the consistency of the gaits is a major consideration. He should carry his head and neck in a relaxed, natural position, with his poll level with or slightly above the level of the withers. He should not carry his head behind the vertical, giving the appearance of intimidation, or be excessively nosed out, giving a resistant appearance. His head should be level, with his nose slightly in front of the vertical, having a bright expression with his ears alert. He should be shown on a reasonably loose rein. He should be responsive, yet smooth, in transitions when called for. When asked to extend, he should move out with the same flowing motion. Maximum credit should be given to the flowing, balanced and willing horse that gives the appearance of being fit and a pleasure to ride. This class will be judged on the performance, condition and conformation of the horse.

SHW.403. A show may have up to three western pleasure classes. If three western pleasure classes are to be held, they shall be (1) senior western pleasure shown with a bit; (2) junior western pleasure shown with either a bit, hackamore or snaffle bit; (3) two-year-old western pleasure shown with hackamore or snaffle which will not be approved prior to July 1 of the year for which approval is requested.

SHW403.1. If two western pleasure classes are to be held, they shall be (1) senior western pleasure shown with a bit; (2) junior western pleasure shown with either bit, hackamore or snaffle bit.

SHW403.2 If only one western pleasure class is to be held, it is to be for all ages.

SHW404. Horses 6 years old and older must be shown on a curb bit.

SHW405. Horses 5 years old and younger may be shown in either curb bit, hackamore or snaffle bit.

SHW406. No horse may be entered in both junior western pleasure and 2-year-old western pleasure at the same show.

SHW407. Entries in the 2-year-old class may be shown with one or both hands on reins. If riding with two hands, reins must be crossed with the tails of the reins on the opposite side of the neck. The rider's hands should be carried near the pommel and not further than four inches (10 cm) out on either side of the saddle horn. Rider's hands must be steady with very limited movement.

SHW408. Horses must work both ways of the ring at all three gaits to demonstrate their ability with different leads. At the option of the judge, horses may be asked to lengthen their stride at the walk or lope, one or both ways of the ring. It is mandatory that a moderate extension of the jog be asked for in at least one direction with the exception of Level I classes, the youth II and under, the youth I3 and under, select western pleasure and 2-year-old western pleasure. However, the moderate extension of the jog remains optional in the above classes. A moderated extension of the jog is a definite two-beat lengthening of stride, covering more ground. Cadenced and balanced with smoothness is more essential than speed. Riders should sit at the moderated extension of the jog. Horses are required to back easily and stand quietly. Passing is

permissible and should not be penalized as long as the horse maintains a proper and even cadence and rhythm.

SHW409. Horses are to be reversed to the inside (away from the rail). They may be required to reverse at the walk or jog at the discretion of the judge, but shall not be asked to reverse at the lope.

SHW410. Judge may ask for additional work of the same nature from any horse.

SHW411. Rider shall not be required to dismount except in the event the judge wishes to check equipment.

SHW412. Horses to be shown at a walk, jog and lope on a reasonably loose rein or light contact without undue restraint.

SHW413. Faults to be scored according to severity:

Excessive speed (any gait)

Being on the wrong lead

Breaking gait (including not walking when called for)

Excessive slowness in any gait, loss of forward momentum (resulting in an animated and/or artificial gait at the lope)

Failure to take the appropriate gait when called for (during transitions, excessive delay will be penalized)

Touching horse or saddle with free hand

Head carried too high

Head carried too low (tip of ear below the withers)

Overflexing or straining neck in head carriage so the nose is carried behind the vertical

Excessive nosing out

Excessive movement of the topline at the lope

Opening mouth excessively

Stumbling

Use of spurs forward of the cinch

Horse appears sullen, dull, lethargic, emaciated, drawn or overly tired

Quick, choppy or pony-strided

Overly canted at the lope (when the outside hind foot is further to the inside of the arena than the inside front foot).

SHW414. Faults that will be cause for disqualification, except in Level I amateur or Level I youth classes, which shall be faults scored according to severity:

Head carried too low and/or clearly behind the vertical excessively and consistently while the horse is in motion, or otherwise showing the appearance of intimidation.

SHW416. RANCH RIDING. The purpose of the Ranch Riding horse should reflect the versatility, attitude, and movement of a working horse. The horse's performance should simulate a horse riding outside the confines of an arena and that of a working ranch horse. This class should show the horse's ability to work at a forward, working speed while under control by the rider. Light contact should be rewarded and horse shall not be shown on a full drape of reins. The overall manners and responsiveness of the horse while performing the maneuver requirements and the horse's quality of movement are the primary considerations.

SHW416.1 For horses three years of age and older, offered as a junior, senior or all-age open division class, and as an all age class for Level I and higher, as an all age class for amateur, and youth.

SHW416.2 No horse may cross enter, a western pleasure and ranch riding class at the same show regardless of division (youth, amateur, select or open).

SHW417. Class requirements:

SHW417.1 Each horse will work individually, performing both required and optional maneuvers, and scored on the basis of 0 to 100, with 70 denoting an average performance. Each maneuver will receive a score that should be added or subtracted from 70 and is subject to a penalty that should be subtracted. Each maneuver will be scored on the following basis, ranging from plus 1 1/2 to minus 1 1/2.: -1 1/2 extremely poor, -1 very poor, -1/2 poor, 0 correct, +1/2 good, +1 very good, +1 1/2 excellent. Maneuver scores are to be determined and assessed independently of penalty points.

SHW417.2 The required maneuvers will include the walk, trot, and lope both directions; and the extended trot and extended lope at least one direction; as well as stops, and back.

SHW417.3 Three optional maneuvers may include a side pass, turns of 360 degrees or more, change of lead (simple or flying), walk, trot, or lope over a pole(s); or some reasonable combination of maneuvers that would be reasonable for a ranch horse to perform.

SHW417.4 The maneuvers may be arranged in various combinations with final approval by the judge.

SHW417.5 The overall cadence and performance of the gaits should be as those described in GAITS, with an emphasis on forward movement, free-flowing, and ground covering for all gaits. Transitions should be performed where designated, with smoothness and responsiveness.

SHW417.6 No time limit.

SHW417.7 One of the suggested patterns may be used, however a judge may utilize a different pattern as long as all required maneuvers and the three (or more) optional maneuvers are included. Should a judge use one of his/her own patterns, it is recommended to not have the stop following an extended lope.

SHW417.8 The use of natural logs is encouraged.

SHW417.9 Posting at the extended trot is acceptable.

SHW417.10 Touching or holding the saddle horn is acceptable.

SHW418. Ranch Riding Apparel and Equipment

SHW418.1 No hoof polish.

SHW418.2 No braided or banded manes or tail extensions.

SHW418.3 Trimming inside ears is discouraged.

SHW418.4 Trimming bridle path is allowed, also trimming of fetlocks or excessive (long) facial hair.

SHW418.5 Equipment with silver should not count over a good working outfit. Silver on bridles and saddles is discouraged.

SHW418.6 It is suggested competitors use a breast collar and a rear cinch.

SHW419. Ranch Riding Penalties. A contestant shall be penalized each time the following occur:

SHW419.1 One (1) point penalties

Too slow/per gait

Over-bridled

Out of frame

Break of gait at walk or jog for 2 strides or less

SHW419.2 Three (3) point penalties

Break of gait at walk or jog for more than 2 strides

Break of gait at lope

Wrong lead or out of lead

RANCH RIDING – PATTERN I

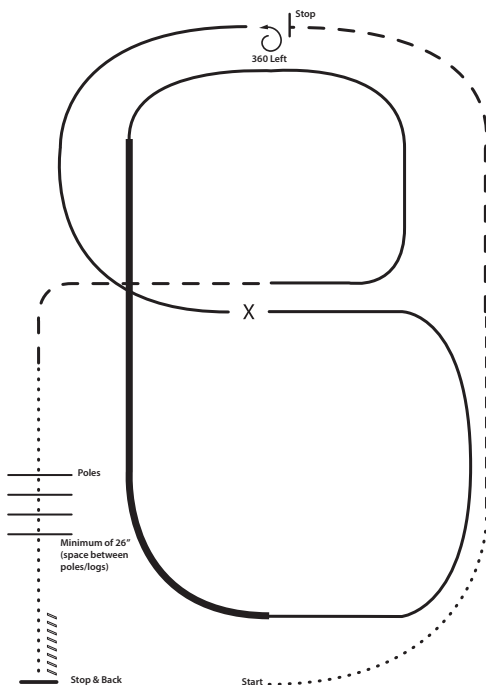

- X Lead Change
- • Walk
- - Trot
- - - Ext Trot
- — — — — Lope
- Ext Lope
- //////// Back

1. Walk
2. Trot
3. Extend the trot, at the top of the arena ,stop
4. 360 degree turn to the left
5. Left lead 1/2 circle, lope to the center
6. Change leads (simple or flying)
7. Right lead 1/2 circle
8. Extended lope up the long side of the arena (right lead)
9. Collect back to a lope around the top of the arena and back to center
10. Break down to an extended trot
11. Walk over poles
12. Stop and back

RANCH RIDING – PATTERN 2

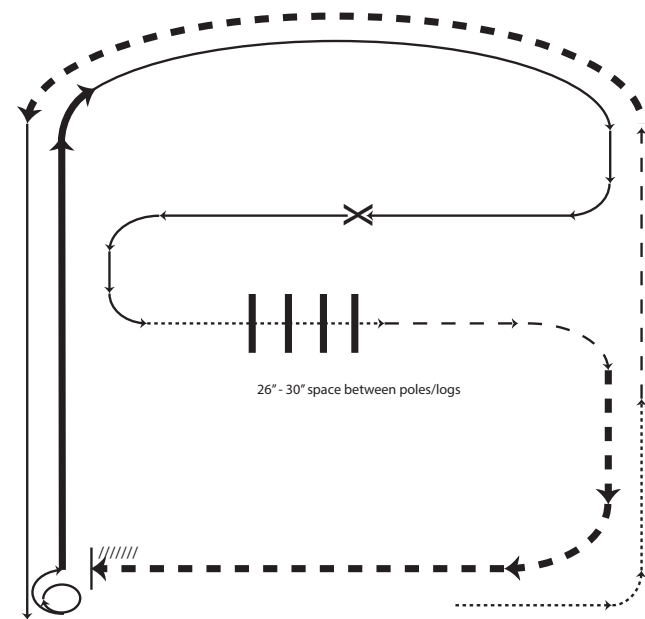

- X Lead Change
- • Walk
- - Trot
- — Ext Trot
- Lope
- Ext Lope
- //// //// Back

1. Walk
2. Trot
3. Extended trot
4. Left lead lope
5. Stop, 1 1/2 turn right
6. Extended lope
7. Collect to working lope-right lead
8. Change leads (simple or flying)
9. Walk
10. Walk over logs
11. Trot
12. Extended trot
13. Stop and back

RANCH RIDING – PATTERN 3

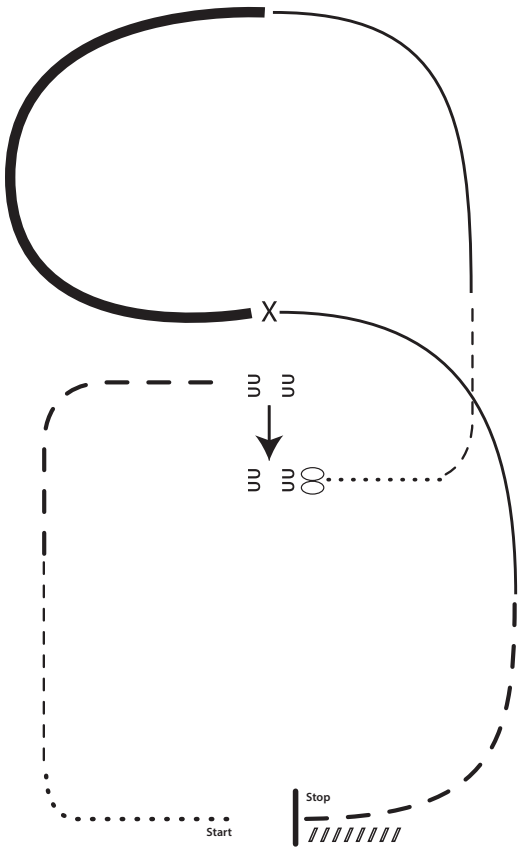

1. Walk to the left around corner of the arena
2. Trot
3. Extend alongside of the arena and around the corner to center
4. Stop, side pass right
5. 360 degree turn each direction (either way 1st)
6. Walk
7. Trot
8. Lope left lead
9. Extend the lope
10. Change leads (simple or flying)
11. Collect to the lope
12. Extend Trot
13. Stop and back

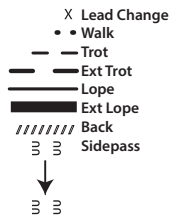

RANCH RIDING – PATTERN 4

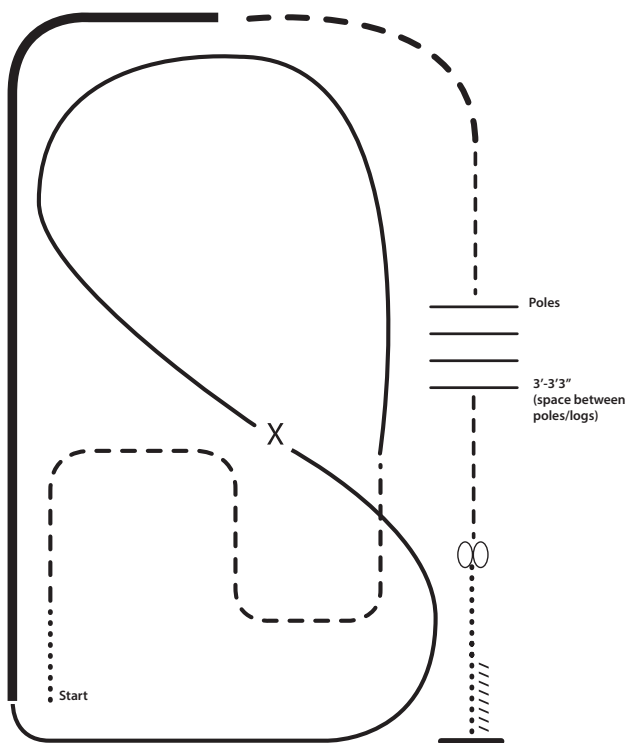

- X Lead Change
- • Walk
- - - Trot
- - - Ext trot
- Lope
- Ext Lope
- //// //// Back

1. Walk
2. Trot serpentine
3. Lope left lead around the end of the arena and then diagonally across the arena
4. Change leads (simple or flying) and
5. Lope on the right lead around end of the arena
6. Extend lope on the straight away and around corner to the center of the arena
7. Extend trot around corner of the arena
8. Collect to a trot
9. Trot over poles
10. Stop, do 360 degree turn each direction (either direction 1st) (L-R or R-L)
11. Walk, stop and back

RANCH RIDING - PATTERN 5

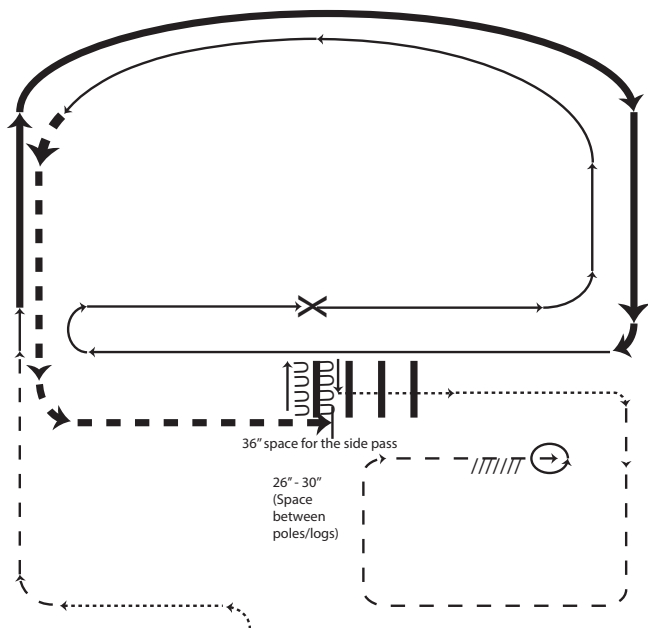

- X Lead Change
- • Walk
- - Trot
- — Ext Trot
- — Lope
- — Ext Lope
- ////// Back

1. Walk
2. Trot
3. Extended lope-right lead
4. Lope-right lead
5. Change leads (simple or flying)
6. Lope left lead
7. Extended trot
8. Stop, side pass left, side pass right, 1/2 way
9. Walk over logs
10. Walk
11. Trot square
12. Stop, 360° turn left, back

Draped reins

Out of lead or cross-cantering more than two strides when changing leads

trotting more than three strides when making a simple lead change

Severe disturbance of any obstacle

SHW419.3 Five (5) point penalties

Blatant disobedience (kick, bite, buck, rear, etc.) for each refusal

SHW419.4 Placed below horses performing all maneuvers

Eliminates maneuver

Incomplete maneuver

SHW419.5 Zero (0) score

Illegal equipment including hoof black, braided or banded manes, or tail extensions

Willfull abuse

Major disobedience or schooling

SHW419.6 No specific penalties will be incurred for nicks/hits on logs but deduction may be made in maneuver score.

SHW419.7 No specific penalties will be incurred for over/under spins but deduction may be made in maneuver score.

SHW430. WESTERN HORSEMANSHIP. Available only in the amateur and youth divisions, western horsemanship is designed to evaluate the rider's ability to execute, in concert with their horse, a set of maneuvers prescribed by the judge with precision and smoothness while exhibiting poise and confidence and maintaining a balanced, functional and fundamentally correct body position. The ideal horsemanship pattern is extremely precise with the rider and horse working in complete unison, executing each maneuver with subtle aids and cues. The horse's head and neck should be carried in a relaxed, natural position, with the poll level with or slightly above the withers. The head should not be carried behind the vertical, giving the appearance of intimidation, or be excessively nosed out, giving a resistant appearance.

SHW430.I It is mandatory that the judge post the initial pattern to be worked at least one hour prior to the commencement of the class; however, if the judge requires additional work of exhibitors for consideration of final placing, an additional pattern may be posted. Pattern(s) should be designed to test the horseman's ability. All ties will be broken at the judges discretion.

SHW431. CLASS PROCEDURES: All exhibitors must enter the ring and then work individually, or each exhibitor may be worked from the gate individually. When exhibitors are worked individually from the gate, a working order is required. Exhibitors should be instructed to either leave the arena, fall into line, or fall into place on the rail after their work. The whole class, or just the finalists, must work at all three gaits at least one direction of the arena. The following maneuvers are acceptable in a pattern: walk, jog, trot, extended trot, lope or extended lope in a straight line, curved line, serpentine, circle or figure 8, or combination of these gaits and maneuvers; stop; back in a straight or curved line; turn or pivot, including spins and rollbacks on the haunches and/or on the forehand; sidepass, two-track or leg-yield; flying or simple change of lead; counter-canter; or any other maneuver; or ride without stirrups. A back should be asked for at some time during the class. Judges should not ask exhibitors to mount or dismount.

SHW432. SCORING: Exhibitors are to be scored from 0 to 100 with 70 denoting an average score. It is suggested a minimum score of 50 be administered except for disqualifications. One-half point increments are acceptable. Maneuver scores will be indicated as follows:

+ = Very Good

√ + = Good

√ = Correct

√ - = Poor

- = Very Poor

SHW432.1 FINAL SCORING shall be on a basis of 0-100 with 70 denoting an average score.

90-100 Excellent rider, including body position and use of aids. Completes pattern accurately, quickly, smoothly and precisely while demonstrating a high level of professionalism.

80-89 Very good performance in execution of the pattern as well as correct horsemanship and use of aids. Excellent horseman that commits a major fault.

70-79 Good pattern execution and average horsemanship lacking adequate style and professional presentation to merit elevating to the next scoring range. A very good rider that commits a major fault or an excellent rider that commits a severe fault.

60-69 Fair pattern that lacks quickness or precision or rider has obvious position and/or appearance faults that prevents effective horsemanship; or a good horseman that commits a major fault in the performance of the pattern. A very good rider that commits a severe fault.

Less than 59 Good pattern with one severe or multiple major/minor faults; excellent or very good rider that commits multiple, and/or combination of, severe, major or minor faults in the performance. A rider that demonstrates a lack of riding ability and knowledge of correct body position.

SHW433. Overall Presentation of Exhibitor and Horse. The exhibitor's overall poise, confidence, appearance and position throughout the class as well as the physical appearance of the horse will be evaluated.

SHW434. Presentation and Position of Exhibitor.

Appropriate western attire must be worn. Clothes and person are to be neat and clean.

SHW434.1 The exhibitor should appear natural in the seat and ride with a balanced, functional and correct position regardless of the maneuver or gait being performed. During the railwork and pattern, the exhibitor should have strong, secure and proper position. Exhibitors should sit and maintain an upright position with the upper body at all gaits.

SHW434.2 The rider should sit in the center of the saddle and the horse's back with the legs hanging to form a straight line from the ear, through the center of the shoulder and hip, touching the back of the heel or through the ankle. The heels should be lower than the toes, with a slight bend in the knee and the lower leg should be directly under the knee. The rider's back should be flat, relaxed and supple. An overly stiff and/or overly arched lower back will be penalized. The shoulders should be back, level and square. The rider's base of support should main-

tain secure contact with the saddle from the seat to the inner thigh. Light contact should be maintained with the saddle and horse from the knee to mid-calf. The knee should point forward and remain closed with no space between the exhibitor's knee and the saddle. The exhibitor will be penalized for positioning the legs excessively behind or forward of the vertical position. Regardless of the type of stirrup, the feet may be placed home in the stirrup, with the boot heel touching the stirrup, or may be placed with the ball of the foot in the center of the stirrup. The rider's toes should be pointing straight ahead or slightly turned out with the ankles straight or slightly broken in. Riding with toes only in the stirrup will be penalized. Those exhibitors that can maintain the proper position throughout all maneuvers should receive more credit. When riding without stirrups, the exhibitor should maintain the same position as previously described. Both hands and arms should be held in a relaxed, easy manner, with the upper arm in a straight line with the body. The arm holding the reins should be bent at the elbow forming a line from the elbow to the horse's mouth. The free hand and arm may be carried bent at the elbow in a similar position as the hand holding the reins or straight down at the riders side. Excessive pumping of the free arm as well as excessive stiffness will be penalized. The rider's wrist is to be kept straight and relaxed, with the hand held at about 30 to 45 degrees inside the vertical. The rein hand should be carried immediately above or slightly in front of the saddle horn. The reins should be adjusted so that the rider has light contact with the horse's mouth, and at no time shall reins require more than a slight hand movement to control the horse. Excessively tight or loose reins will be penalized.

SHW434.3 The rider's head should be held with the chin level and the eyes forward, and may be directed slightly toward the direction of travel. Excessive turning of the head to the inside of the circle, or down at the horse's head or shoulder will be penalized.

SHW434.4 The exhibitor should not crowd the exhibitor next to or in front of them when working on the rail and should pass to the inside of the arena. When reversing on the rail, the exhibitor should always reverse to the inside of the arena.

SHW435. Presentation of Horse.

The horse's body condition and overall health and fitness should be assessed. The horse should appear fit and carry weight appropriate for the body size. A horse which appears sullen, dull, lethargic, emaciated, drawn or overly tired should be penalized according to severity. Tack should fit the horse properly and be neat, clean and in good repair.

SHW436. Performance.

The exhibitor should perform the work accurately, precisely, smoothly, and with a reasonable amount of promptness. Increasing speed of the maneuvers performed increases the degree of difficulty; however, accuracy and precision should not be sacrificed for speed. Exhibitors that perform the pattern sluggishly and allow their horse to move without adequate impulsion, collection or cadence will be penalized.

SHW436.I The horse should perform all maneuvers in the pattern willingly, briskly and readily with minimal visible or audible cueing. Severe disobedience will not result in a disqualification,

but should be severely penalized, and the exhibitor should not place above an exhibitor that completes the pattern correctly. Failure to follow the prescribed pattern, knocking over or working on the wrong side of the cones, excessive schooling or training, or willful abuse by the exhibitor is cause for disqualification.

SHW436.2 The horse should track straight, freely and at the proper cadence for the prescribed gait. Transitions should be smooth and prompt in the pattern and on the rail, and should be performed when called for on the rail. The horse's head and neck should be straight and in line with their body while performing straight lines and slightly arched to the inside on curved lines or circles. Circles should be round and performed at the appropriate speed, size and location as requested in the pattern. The counter-canter should be performed smoothly with no change in cadence or stride unless specified in the pattern.

SHW436.3 The stop should be straight, square, prompt, smooth and responsive with the horse maintaining a straight body position throughout the maneuver. The back should be smooth and responsive.

SHW436.4 Turns should be smooth and continuous. When performing a turn on the haunches, the horse should pivot on the inside hind leg and step across with the front legs. A rollback is a stop and 180 degree turn over the hocks with no hesitation. Backing during turns will be penalized severely.

SHW436.5 The horse should step across with the front and hind legs when performing the sidepass, leg-yield and two-track. The side pass should be performed with the horse keeping the body straight while moving directly lateral in the specified direction. When performing a leg-yield, the horse should move forward and lateral in a diagonal direction with the horse's body arced opposite to the direction that the horse is moving. In the two-track, the horse should move forward and lateral in a diagonal direction with the horse's body held straight or bent in the direction the horse is moving.

SHW436.6 A simple or flying change of lead should be executed precisely in the specified number of strides and/or at the designated location. A simple change of lead is performed by breaking to a walk or trot for one to three strides. Flying changes should be simultaneous front and rear. All changes should be smooth and timely.

SHW436.7 Position of the exhibitor and performance of the horse and rider on the rail must be considered in the final placing.

SHW437. FAULTS. Faults can be classified as minor, major or severe. The judge will determine the appropriate classification of a fault based upon the degree and/or frequency of the infraction. An exhibitor that incurs a severe fault avoids elimination, but should be placed below all other exhibitors that complete the pattern correctly. A minor fault can become a major fault and a major fault can become a severe fault when the degree and/or frequency of the infraction(s) merits.

SHW437.1 Minor faults - Deduction of 5 points

Break of gait at walk or jog/trot up to 2 strides

Over/under turn from 1/8 to 1/4

Tick or hit of cone

Obviously looking down to check leads

SHW437.2 Major faults - Deduction of 10 points

Break of gait at a lope, out of lead or missing lead for 1-2 strides
Not performing the specific gait or not stopping when called for in the pattern within 10 feet (3 meters) of designated area
Incorrect lead or break of gait (except when correcting an incorrect lead)

Break of gait at walk, jog or trot for more than two strides
Loss of stirrup

Head carried too low and/or clearly behind the vertical while the horse is in motion, showing the appearance of intimidation

SHW437.3 Severe Faults - Deduction of 20 points (avoids disqualification but should be placed below other exhibitors who do not incur a severe fault) include:

Loss of stirrup or rein

Use of either hand to instill fear or praise while on pattern or during rail work

Holding saddle with either hand

Cueing with the end of the romal

Blatant disobedience including kicking, pawing, bucking and rearing

Spurring in front of the cinch

SHW437.4 Disqualifications (should not be placed) include:

Failure to display correct number

Abuse of horse or schooling

Knocking over the cone, going off pattern or working on wrong side of cone

Fall by horse or rider

Illegal equipment or illegal use of hands on reins

Use of prohibited equipment

Off pattern, including: knocking over cone or wrong side of cone or marker; never performing designated gait or lead; over or under turning more than 1/4 turn

SHW437.5 Faults scored according to severity, which will be cause for disqualification, except in Level I amateur or Level I youth classes include:

Head carried too low and/or clearly behind the vertical excessively and consistently while the horse is in motion, or otherwise showing the appearance of intimidation.

SHW438. ROOKIE/LEVEL I Classes Only: Exhibitors going off pattern, knocking over or on wrong side of cone, never performing specified gait, or overturning more than 1/4 turn than designated, shall not be disqualified, but must always place below exhibitors not incurring a disqualifying fault.

SHW450. LEVEL I WESTERN RIDING. The purpose of Level I western riding is to allow a horse to compete in a field with minimally accomplished horses of the same level of experience. The Level I western riding is a stepping-stone to the more advanced competition of Level 2/Level 3. Emphasis is on movement and quality of lead change while allowing for leniency in assistance from the exhibitor, while still rewarding softness and willingness. Credit will be placed on smoothness, even cadence of gaits and the horse's ability to change leads precisely, easily and simultaneously, both front and hind.

SHW450.I Horses, regardless of their age, may be ridden with one hand and a standard western bit as approved by the AQHA equipment rules or with two hands and a snaffle bit or bosal as described under AQHA equipment rules.

SHW450.2 With the exception of eligibility and equipment requirements, the same rules apply in Level I western riding as apply in western riding. The pattern must be selected from one of the three level I patterns.

SHW450.4 Horses are eligible to compete if they have not, as of January 1 of the current show year:

SHW450.4.1 won 25 points or more in AQHA-approved western riding classes (horse points from all levels in any division will count including introduction/rookie points and are cumulative in determining eligibility); or

SHW450.4.2 won \$1,000 or more in any equine organization or association in western riding classes.

SHW450.4.3 Accuracy of eligibility is the responsibility of the owner or exhibitor.

SHW451. WESTERN RIDING. The horse is judged on quality of gaits, lead changes at the lope, response to the rider, manners and disposition. The horse should perform with reasonable speed, and be sensible, well-mannered, free and easy moving. Credit shall be given for and emphasis placed on smoothness, even cadence of gaits (i.e., starting and finishing pattern with the same cadence), and the horse's ability to change leads precisely, easily and simultaneously both hind and front at the center point between markers. In order to have balance, with quality lead changes, the horse's head and neck should be in a relaxed, natural position, with his poll level with or slightly above the level of the withers. He should not carry his head behind the vertical, giving the appearance of intimidation, or be excessively nosed out, giving a resistant appearance. The horse should have a relaxed head carriage showing response to the rider's hands, with a moderate flexion at the poll. Horses may be ridden with light contact or on a reasonably loose rein. The horse should cross the log both at the jog and the lope without breaking gait or radically changing stride.

SHW452. The judge will select one of the eight patterns to be performed. The judge is responsible for the pattern being correctly set. The three Level I western riding patterns may be used for Level I amateur or Level I youth. On the pattern:

SHW452.1 The small circles represent pylon markers which are recommended. These should be separated by a uniform measured distance of not less than 30 feet (9 meters) nor more than 50 feet (15 meters) on the sides with 5 markers (see diagram). In Pattern I, the three markers on the opposite side should be set adjacent to the appropriate markers. It is recommended that markers be set a minimum of 15 feet (4 1/2 meters) from the fence and with 50 to 80 foot (15 to 24 meters) width in the pattern, as the arena permits.

SHW452.2 A solid log or pole should be used and be a minimum of 8 feet (2.5 meters) in length.

SHW452.3 The long serpentine line indicates the direction of travel and gaits at which the horse is to move. The shaded area represents the lead changing area between the markers. The dotted line (...) indicates walk, the dash line (- - -) jog, and the solid line (-) lope.

SHW452.4 A cone shall be placed along the wall or rail of the arena to designate where the exhibitor should initiate the walk.

On Pattern 1, the cone should be placed a minimum of 15 feet before the first pylon. On Patterns 2,3,4 and 5, the cone should be placed even with the first pylon. The on-deck exhibitor should not go to the start-cone until the contestant on pattern has cleared the working area by the start-cone for the final time.

SHW453. SCORING. Exhibitors will be scored on a basis of 0-100 with 70 denoting an average performance. Points will be added or subtracted from the maneuvers on the following bases, ranging from plus 1 1/2 to minus 1 1/2: -1 1/2 extremely poor, -1 very poor, -1/2 poor, 0 average, +1/2 good, +1 very good, +1 1/2 excellent. Maneuver scores are to be determined independently of penalty points.

SHW454. Penalties should be assessed each time the following occur:

SHW454.1 One-half (1/2) point

tick or light touch of log

SHW454.2 One (1) point

hitting or rolling log

out of lead more than one stride either side of the center point and between the markers

splitting the log (log between the two front or two hind feet) at the lope

hind legs skipping or coming together during lead change

break of gait at the walk or jog up to two strides

non-simultaneous lead change (front to hind or hind to front)

SHW454.3 Three (3) points

not performing the specific gait (jog or lope) or not stopping when called for in the pattern, within 10 feet (3 meters) of the designated area

simple change of leads

out of lead at or before the marker prior to the designated change area or out of lead at or after the marker after the designated change area

additional lead changes anywhere in pattern (except when correcting an extra change or incorrect lead)

in Pattern 1 and 3 failure to start the lope within 30 feet (9 meters) after crossing the log at the jog

break of gait at walk or jog for more than two strides

break of gait at the lope

SHW454.4 Five (5) points

out of lead beyond the next designated change area (note: failures to change, including cross-cantering. Two consecutive failures to change would result in two five point penalties).

blatant disobedience including kicking out, biting, bucking and rearing

holding saddle with either hand

use of either hand to instill fear or praise

SHW454.5 Disqualified - 0 score

illegal equipment

willful abuse

off course

knocking over markers

completely missing log

major refusal - stop and back more than two strides or four steps with front legs

major disobedience or schooling

failure to start lope prior to end cone in Pattern I
four or more simple lead changes and/or failures to change leads (except for Level I and Rookie classes)
failure to start lope beyond 30 feet of designated area in Patterns 2, 3, 4, 5 and Level I Western Riding Patterns 1, 2 and 4 (except for Level I classes).
overturn of more than 1/4 turn

SHW454.6 Faults scored according to severity, which will be cause for disqualification, except in Level I amateur or Level I youth classes, include:

Head carried too low and/or clearly behind the vertical excessively and consistently while the horse is in motion, or otherwise showing the appearance of intimidation.

SHW454.7 The following characteristics are considered faults and should be judged accordingly in maneuver scores:

opening mouth excessively
anticipating signals
stumbling
head carried too high
head carried too low (tip of ear below the withers)
over-flexing or straining neck in head carriage so the nose is carried behind the vertical
excessive nosing out

SHW454.8 Credits

changes of leads, hind and front simultaneously
change of lead near the center point of the lead change area
accurate and smooth pattern
even pace throughout
easy to guide and control with rein and leg
manners and disposition
conformation and fitness

SHW460. LEVEL I TRAIL. The purpose of Level I trail is to allow a horse to compete in a field with minimally accomplished horses of the same level of experience. The Level I trail is a stepping-stone to the more advanced competition of Level 2/Level 3. This class should be judged on the performance of the horse over obstacles with emphasis on movement, smoothness in gaits and transitions and willingness to execute the maneuvers with a willing attitude. Horses shall be penalized for artificial appearance over the obstacles.

SHW460.1 The course should be designed for the entry-level horse. Ample space should be used to execute the obstacles.

SHW460.2 Horses, regardless of their age, may be ridden with one hand and a standard western bit as approved by AQHA equipment rules or with two hands and a snaffle bit or bosal as described under AQHA equipment rules.

SHW460.3 With the exception of eligibility and equipment requirements, the same rules apply in Level I trail as apply in trail.

SHW460.4 Horses are eligible to compete if they have not, as of January 1 of the current show year:

SHW460.4.1 won 25 points or more in AQHA-approved trail classes (horse points from all levels in any division will count including introductory/rookie points and are cumulative in determining eligibility); or

SHW460.4.2 won \$1,000 or more in any equine organization or association in trail classes.

SHW460.4.3 Accuracy of eligibility is the responsibility

Location Penalties for Designated Change

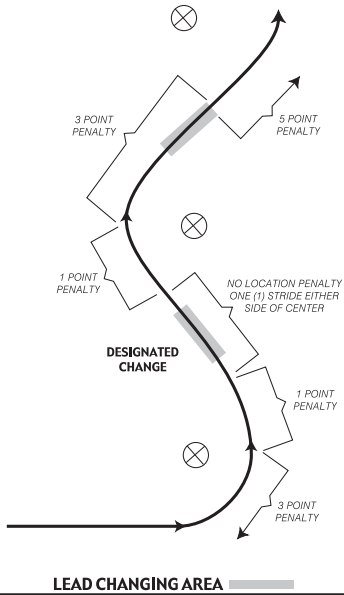

Location Penalties for Designated Change

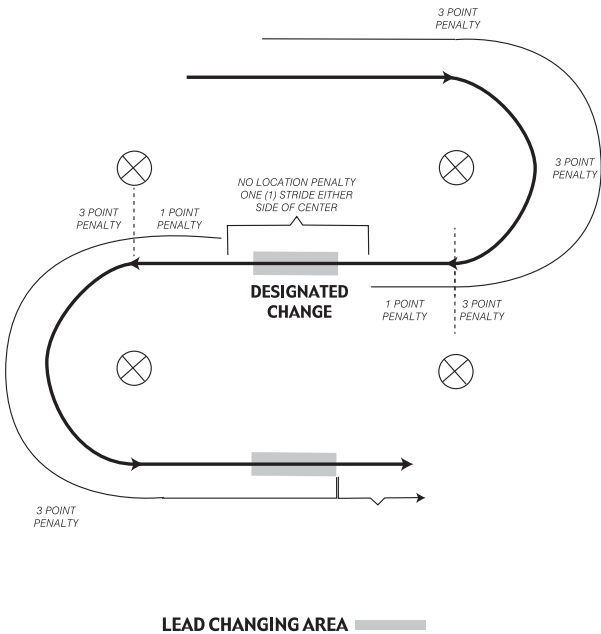

WESTERN RIDING PATTERN I

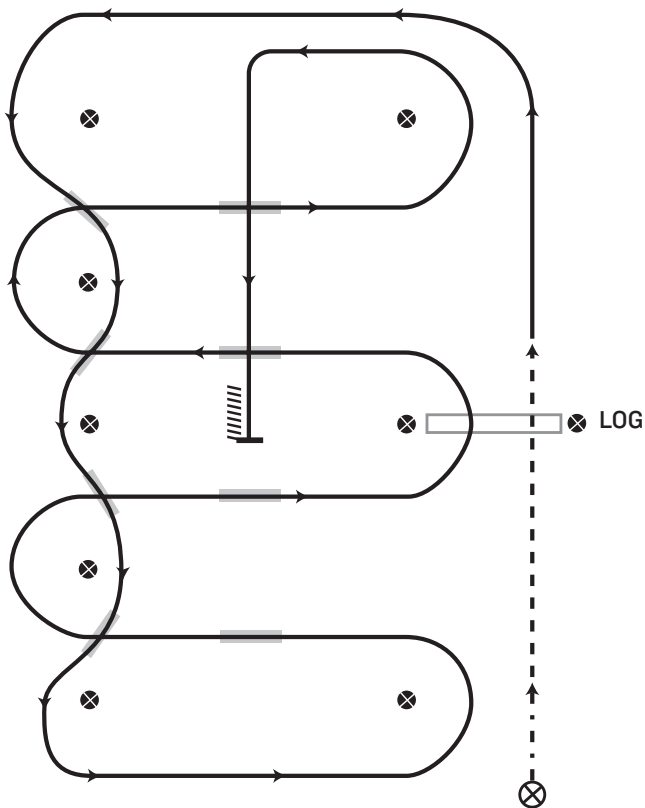

1. Walk at least 15 feet from start cone to the first marker. Start jogging at first marker and jog over log.
2. Transition to left lead & lope around end
3. First line change
4. Second line change
5. Third line change
6. Fourth line change lope around the end of arena
7. First crossing change
8. Second crossing change
9. Lope over log
10. Third crossing change
11. Fourth crossing change
12. Lope up the center, stop & back

WESTERN RIDING PATTERN 2

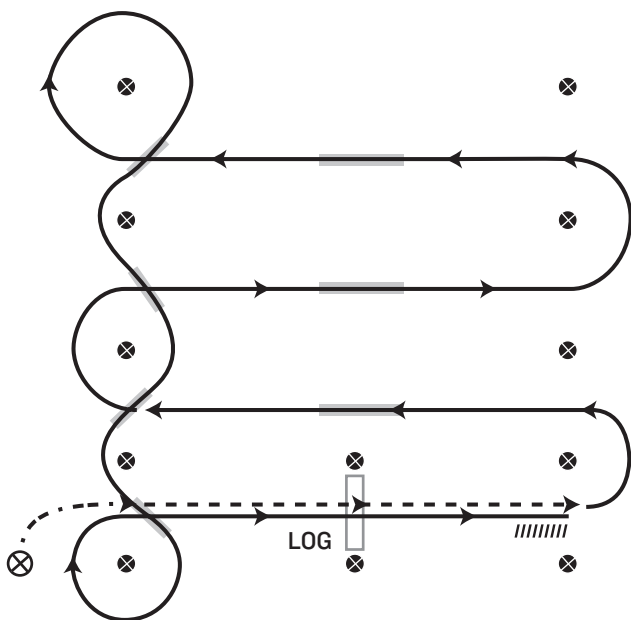

⊗ START
CONE

WALK - · - · - ·

JOG - - - - -

LEAD CHANGING AREA 

LOPE 

1. Walk, transition to jog, jog over log
2. Transition to the lope, on the left lead
3. First crossing change
4. Second crossing change
5. Third crossing change
6. Circle & first line change
7. Second line change
8. Third line change
9. Fourth line change & circle
10. Lope over log
11. Lope, stop & back

WESTERN RIDING PATTERN 3

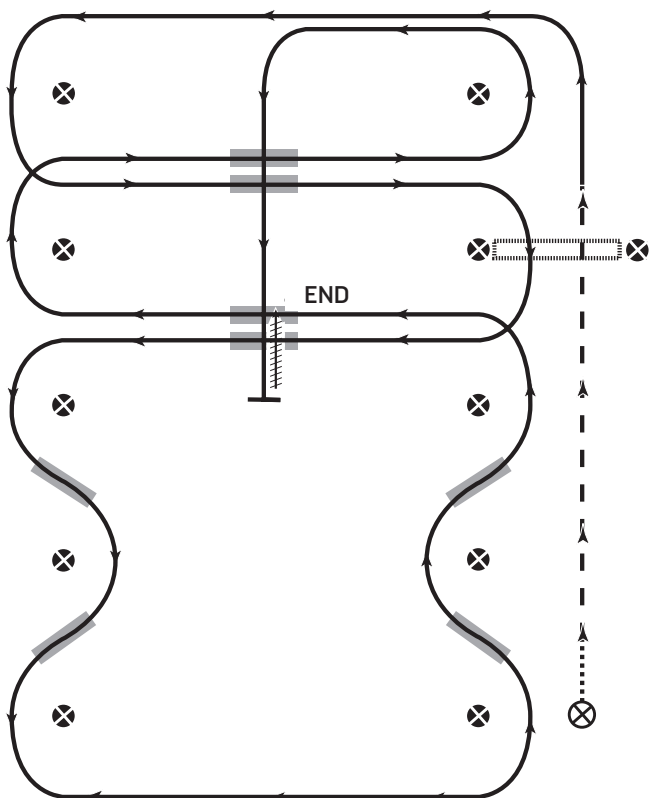

WALK **JOG** - - - **LOPE** ———

LEAD CHANGING AREA [shaded rectangle] ⊗ **START CONE**

1. Walk halfway between markers, transition to jog, jog over log
2. Transition to the lope, on the left lead
3. First crossing change
4. Lope over log
5. Second crossing change
6. First line change
7. Second line change
8. Third line change
9. Fourth line change
10. Third crossing change
11. Fourth crossing change
12. Lope up the center, stop & back

WESTERN RIDING PATTERN 4

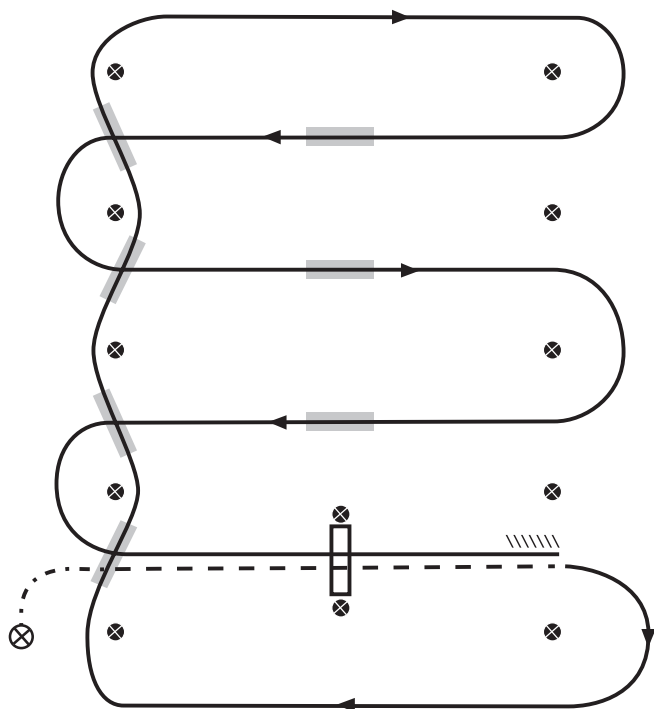

⊗ START CONE WALK - - - - JOG - - - -
 LEAD CHANGING AREA [SHADE] LOPE _____

1. Walk, transition to jog, jog over log
2. Transition to the lope, on the right lead
3. First line change
4. Second line change
5. Third line change
6. Fourth line change
7. First crossing change
8. Second crossing change
9. Third crossing change
10. Lope over log
11. Lope, stop & back

WESTERN RIDING PATTERN 5
Recommended For Small Arenas

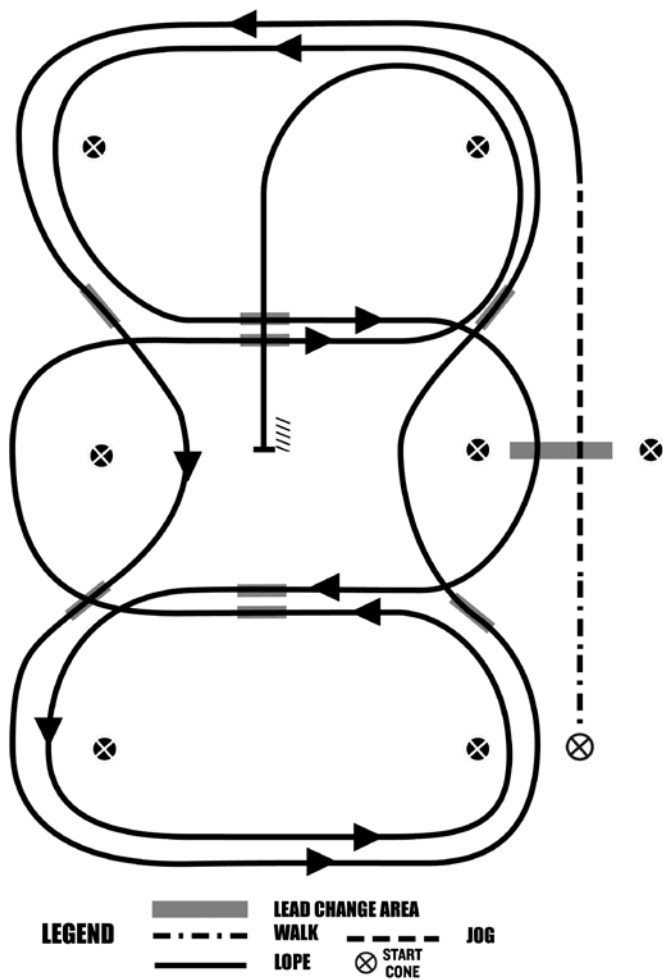

1. Walk, transition to jog, jog over log
2. Transition to the lope, on the left lead
3. First line change
4. Second line change
5. Third line change
6. Fourth line change
7. First crossing change
8. Lope over log
9. Second crossing change
10. Third crossing change
11. Fourth crossing change
12. Lope, stop & back

LEVEL I WESTERN RIDING PATTERN I

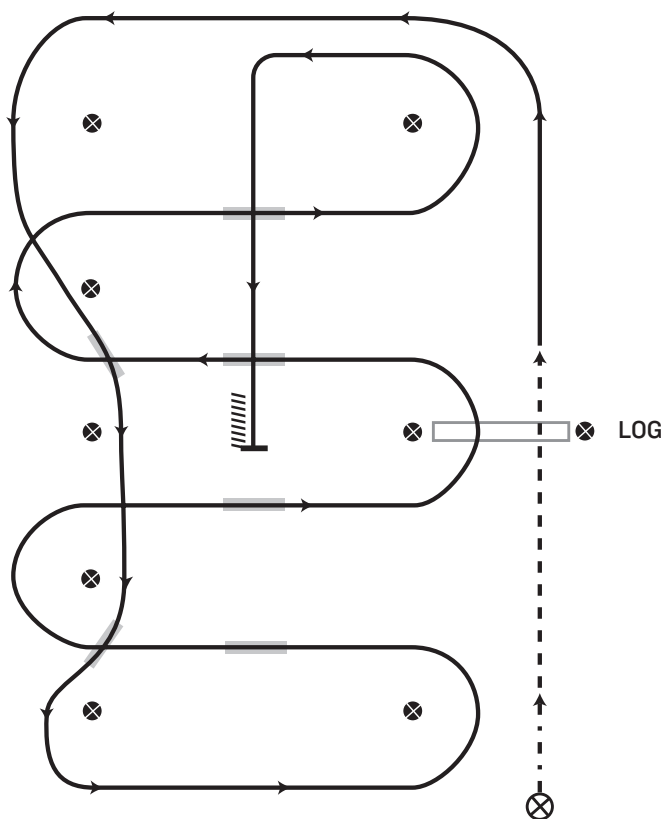

1. Walk at least 15' & jog over log
2. Transition to left lead & lope around end
3. First line change
4. Second line change lope around the end of arena
5. First crossing change
6. Second crossing change
7. Lope over log
8. Third crossing change
9. Fourth crossing change
10. Lope up the center, stop & back

LEVEL I WESTERN RIDING PATTERN 2

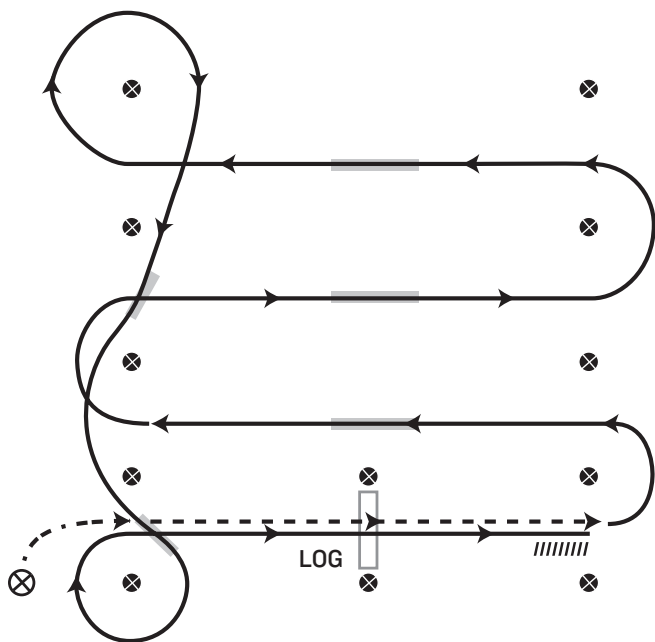

START
CONE

WALK - - - - -

JOG - - - - -

LEAD CHANGING AREA 

LOPE 

1. Walk, transition to jog, jog over log
2. Transition to left lead lope
3. First crossing change
4. Second crossing change
5. Third crossing change
6. Circle & first line change
7. Second line change & circle
8. Lope over log
9. Stop & back

LEVEL I WESTERN RIDING PATTERN 3

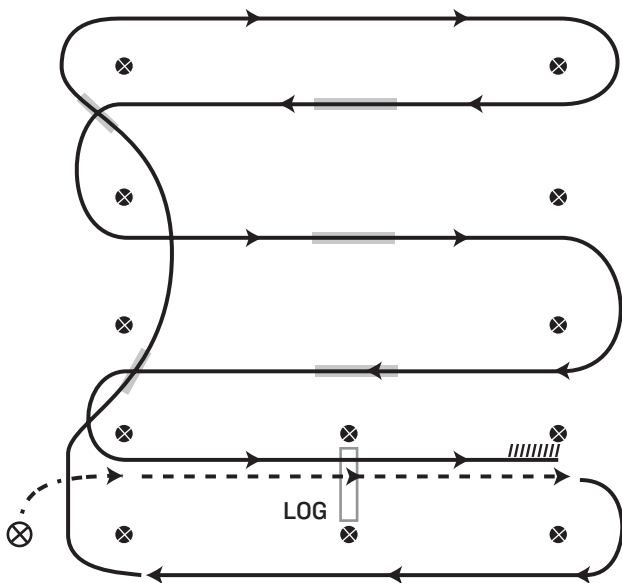

1. Walk, transition to jog, jog over log
2. Transition to right lead & lope around end
3. First line change
4. Second line change, lope around end of arena
5. First crossing change
6. Second crossing change
7. Third crossing change
8. Lope over log
9. Lope, stop & back

of the owner or exhibitor.

SHW461. TRAIL. This class will be judged on the performance of the horse over obstacles, with emphasis on manners, response to the rider and quality of movement. Credit will be given to horses negotiating the obstacles with style and some degree of speed, providing correctness is not sacrificed. Horses should receive credit for showing attentiveness to the obstacles and the capability of picking their own way through the course when obstacles warrant it, and willingly responding to the rider's cues on more difficult obstacles. Horses shall be penalized for any unnecessary delay while approaching or negotiating the obstacles. Horses with artificial appearance over obstacles should be penalized. Horses must not be required to work on the rail. The course must be designed, however, to require each horse to show the three gaits (walk, jog, lope) somewhere between obstacles as a part of its work, and quality of movement and cadence should be considered as part of the maneuver score. While on the line of travel between obstacles, the horse shall be balanced, carrying his head and neck in a relaxed, natural position, with the poll level with or slightly above the withers. The head should not be carried behind the vertical, giving the appearance of intimidation, or be excessively nosed out, giving a resistant appearance.

SHW462. The course to be used must be posted at least one hour before scheduled starting time of the class.

SHW463. SCORING. Scoring will be on the basis of 0-infinity, with 70 denoting an average performance. Each obstacle will receive an obstacle score that should be added or subtracted from 70 and is subject to a penalty that should be subtracted. Each obstacle will be scored on the following basis, ranging from plus 1 1/2 to minus 1 1/2: -1 1/2 extremely poor, -1 very poor, -1/2 poor, 0 correct, +1/2 good, +1 very good, +1 1/2 excellent. Obstacle scores are to be determined and assessed independently of penalty points.

SHW464. Penalties should be assessed, per occurrence, as follows:

SHW464.1 One-half (1/2) point

each tick or contact of a log, pole, cone, plant, or any component of an obstacle

SHW464.2 One (1) point

each hit, bite, or stepping on a log, cone, plant or any component of the obstacle

incorrect or break of gait at walk or jog for two strides or less both front or hind feet in a single-strided slot or space at a walk or jog

skipping over or failing to step into required space

split pole in lope-over

incorrect number of strides, if specified

SHW464.3 Three (3) points

incorrect or break of gait at walk or jog for more than two strides

out of lead or break of gait at lope (except when correcting an incorrect lead)

knocking down an elevated pole, cone, barrel, plant, obstacle, or severely disturbing an obstacle

falling or jumping off or out of a bridge or a water box with one foot once the horse has got onto or into that obstacle

stepping outside of the confines of an obstacle with designated

boundaries (i.e. back through, 360 degree box, side pass) with one foot once the horse has entered the obstacle.
missing or evading a pole that is a part of a series of an obstacle with one foot

SHW464.4 Five (5) points

dropping slicker or object required to be carried on course
first or second cumulative refusal, balk, or evading an obstacle by shying or backing
letting go of gate or dropping rope gate
use of either hand to instill fear or praise
falling or jumping off or out of a bridge or a water box with more than one foot once the horse has got onto or into that obstacle
stepping outside of the confines of an obstacle with designated boundaries (i.e. back through, 360 degree box, side pass) with more than one foot once the horse has entered the obstacle.
missing or evading a pole that is a part of a series of an obstacle with more than one foot
blatant disobedience (including kicking out, bucking, rearing, striking)
holding saddle with either hand

SHW464.5 Disqualified 0 – Score

use of two hands (except in snaffle bit or hackamore classes designated for two hands) or changing hands on reins; except for junior horses shown with hackamore or snaffle bit, only one hand may be used on the reins, except that it is permissible to change hands to work an obstacle as outlined in WESTERN EQUIPMENT, or to straighten reins when stopped.
use of romal other than as outlined in WESTERN EQUIPMENT
performing the obstacle incorrectly or other than in specified order
no attempt to perform an obstacle
equipment failure that delays completion of pattern
excessively or repeatedly touching the horse on the neck to lower the head
entering or exiting an obstacle from the incorrect side or direction
working obstacle the incorrect direction; including overturns of more than 1/4 turn
riding outside designated boundary marker of the arena or course area
third cumulative refusal, balk, or evading an obstacle by shying or backing
failure to ever demonstrate correct lead and/or gait as designated
failure to follow the correct line of travel between obstacles
excessive schooling, pulling, turning, stepping or backing anywhere on course
failure to open and shut gate or failure to complete gate (except for level I or rookie classes where they place below all who complete course correctly)

SHW464.6 Faults scored according to severity which occur on the line of travel between obstacles include:

head carried too high

Head carried too low and/or clearly behind the vertical excessively and consistently while the horse is in motion, or otherwise showing the appearance of intimidation.

opening mouth excessively

SHW464.7 Faults which will be cause for disqualification

that occur on the line of travel between obstacles, except in Level I amateur or Level I youth classes which shall be faults scored according to severity, include (1) head carried too low (tip of ear below the withers consistently); (2) over-flexing or straining neck in head carriage so the nose is carried behind the vertical consistently.

SHW465. Trail Course. Management, when setting courses, should keep in mind that the idea is not to trap a horse, or eliminate it by making an obstacle too difficult. All courses and obstacles are to be constructed with safety in mind so as to eliminate any accidents. If difficult courses are set, Level I trail should be less difficult. When the distances and spaces are measured between all obstacles, the inside base to inside base measurement of each obstacle considering the normal path of the horse should be the measuring point. Enough space must be provided for a horse to jog [at least 30 feet (9 meters)] and lope [at least 50 feet (15 meters)] for the judges to evaluate these gaits.

SHW465.1 If disrupted, the course shall be reset. In the case that an obstacle is used in combination, the obstacle cannot be reset until the contestant finishes the entire obstacle.

SHW465.2 The judge must walk the course and has the right and duty to alter the course in any manner. The judge may remove or change any obstacle he deems unsafe or non-negotiable. If at any time a trail obstacle is deemed to be unsafe by the judge, it shall be repaired or removed from the course. If it cannot be repaired and horses have completed the course, the score for that obstacle shall be deducted from all previous works for that class.

SHW465.3 At least six obstacles must be used, three of which must be from the mandatory list of obstacles and at least three others selected from the list of optional obstacles.

SHW466. Mandatory trail course obstacles include:

SHW466.1 Opening, passing through and closing gate. (Losing control of gate is to be penalized.) Use a gate which will not endanger horse or rider. If the gate has a metal, plastic or wooden support bar under the opening, contestants must work the gate moving forward through it.

SHW466.2 Ride over at least four logs or poles. These can be in a straight line, curved, zigzag or raised. The space between the logs is to be measured and the path the horse is to take should be the measuring point. Trotovers and lopeovers cannot be elevated in Level I classes. All elevated elements must be placed in a cup, notched block, or otherwise secured so they cannot roll. The height should be measured from the ground to the top of the element. Spacing for walkovers, trotovers, and lopeovers should be as follows or increments thereof.

SHW466.2.1 The spacing for walkovers shall be 20" to 24" (50 - 60 cm) and may be elevated to 12" (30 cm). Elevated walkovers should be set at least 22" (55 cm) apart.

SHW466.2.2 The spacing for trotovers shall be 3' to 3'3" (90 -100 cm) and may be elevated to 8" (20 cm).

SHW466.2.3 The spacing for lopeovers shall be 6' to 6

SAMPLE TRAIL

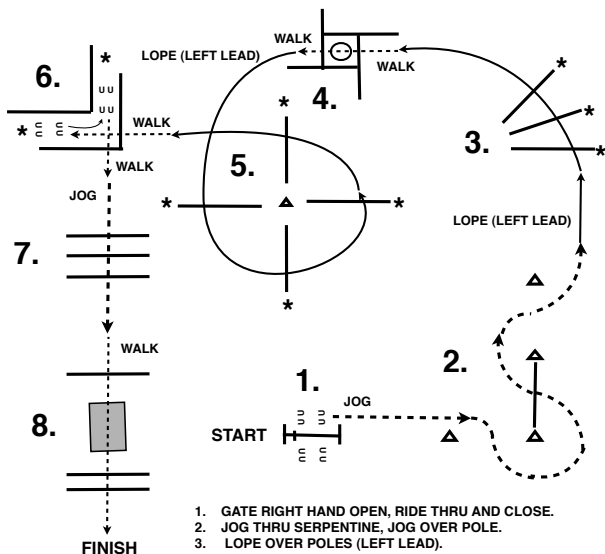

1. GATE RIGHT HAND OPEN, RIDE THRU AND CLOSE.
2. JOG THRU SERPENTINE, JOG OVER POLE.
3. LOPE OVER POLES (LEFT LEAD).
4. STOP OR BREAK TO THE WALK, WALK INTO BOX, 360 TURN EITHER DIRECTION, WALK OUT BOX.
5. LOPE OVER SPOKE (LEFT LEAD).
6. STOP OR BREAK TO THE WALK, WALK INTO "L" BACK AROUND CORNER, WALK OUT "L".
7. JOG OVER POLES.
8. STOP OR BREAK TO THE WALK, WALK OVER POLES AND OVER BRIDGE.

SAMPLE TRAIL

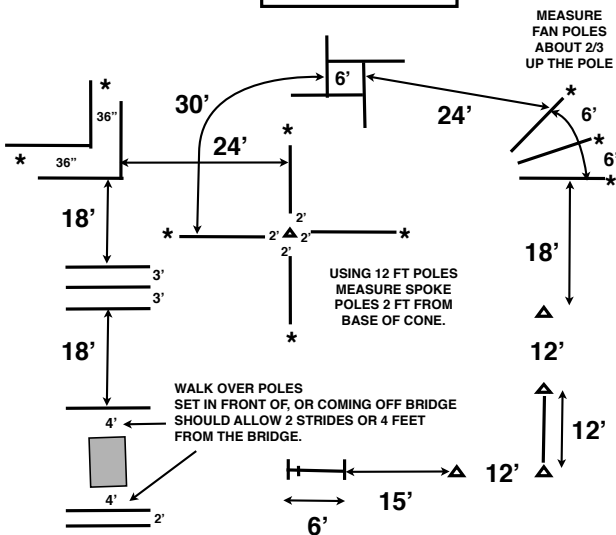

A STANDARD BRIDGE SHOULD BE AT LEAST 3 FEET IN WIDTH AND AT LEAST 6 FT IN LENGTH

A STANDARD GATE SHOULD BE AT LEAST 6 FEET IN WIDTH INSIDE THE OPENING.

1/2' (1.8 - 2 meters) or increments thereof, and may be elevated to 8" (20 cm).

SHW466.3 Backing obstacle. Backing obstacles to be spaced a minimum of 28" (70 cm). If elevated, 30" (75 cm) spacing is required. Entrants cannot be asked to back over a stationary object such as a wooden pole or metal bar.

SHW466.3.1 Back through and around at least three markers.

SHW466.3.2 Back through L, V, U, straight or similar-shaped course. May be elevated no more than 24" (60 cm).

SHW467. Optional trail course obstacles include but are not limited to:

SHW467.1 Water hazard (ditch or small pond). No metal or slick bottom-boxes will be used.

SHW467.2 Serpentine obstacles at walk or jog. Spacing to be minimum of 6' (1.8 meters) for jog.

SHW467.3 Carry object from one part of arena to another. (Only objects which reasonably might be carried on a trail ride may be used.)

SHW467.4 Ride over wooden bridge. (Suggested minimum width shall be 36" (90 cm) wide and at least six feet long). Bridge should be sturdy, safe and negotiated at a walk only.

SHW467.5 Put on and remove slicker.

SHW467.6 Remove and replace materials from mailbox.

SHW467.7 Side pass (may be elevated to 12" (30 cm) maximum).

SHW467.8 An obstacle consisting of four logs or rails, laid in a square. Minimum width of the square should be 6' (1.8 m). Each contestant will enter the square by riding over log or rail as designated. When all four feet are inside the square, rider should execute a turn, as indicated, and depart.

SHW467.9 Any other safe and negotiable obstacle which could reasonably be expected to be encountered on a trail ride and meets the approval of the judge may be used.

SHW467.10 A combination of two or more of any obstacle is acceptable.

SHW468. Unacceptable trail course obstacles include:

Tires

Animals

Hides

PVC pipe

Dismounting

Jumps

Rocking or moving bridges

Water box with floating or moving parts

Flames, dry ice, fire extinguisher, etc.

Logs or poles elevated in a manner that permits such to roll

Ground ties

SHW480. REINING. Reining is a judged event designed to show the athletic ability of a ranch type horse in the confines of a show arena. In reining competition, contestants are required to run one of several approved patterns. Each pattern includes small slow circles, large fast circles, flying lead changes, rollbacks over the hocks, a series of 360 degree spins done in place, and the exciting sliding stops that are the hallmark of the reining horse. To rein a horse is not only to guide him, but also to control his every movement. The best reined horse should be willingly guided or

controlled with little or no apparent resistance and dictated to completely. Any movement on his own must be considered a lack of control. Any one of the 15 AQHA-approved reining patterns may be used and is to be selected by the judge of the class and used by all contestants in the class. Each contestant will perform the required pattern individually and separately. All horses will be judged immediately upon entering the arena. Any fault incurred prior to the commencement of a pattern will be scored accordingly. All deviations from the exact written pattern must be considered a lack of or temporary loss of control, and therefore faulted according to severity of deviation. Credit will be given for smoothness, finesse, attitude, quickness and authority in performing the various maneuvers while using controlled speed.

SHW481. SCORING. Scoring will be on the basis of 0-Infinity, with 70 denoting an average performance. Points will be added or subtracted from the maneuvers on the following bases, ranging from plus 1 1/2 to minus 1 1/2: -1 1/2 extremely poor, -1 very poor, -1/2 poor, 0 average, +1/2 good, +1 very good, +1 1/2 excellent. Maneuver scores are to be determined independently of penalty points.

SHW482. The following will result in no score:

Abuse of an animal in the show arena and/or evidence that an act of abuse has occurred prior to or during the exhibition of a horse in competition;

Use of illegal equipment, including wire on bits, bosals or curb chains;

Use of illegal bits, bosals or curb chains; when using a snaffle bit, optional curb strap is acceptable; however, curb chains are not acceptable.

Use of tack collars, tie downs or nose bands;

Use of whips or bats;

Use of any attachment which alters the movement of or circulation to the tail;

Failure to provide horse and equipment to the appropriate judge for inspection;

Disrespect or misconduct by the exhibitor;

Closed reins are not allowed except as standard romal reins.

Excess rein may be straightened anytime during the pattern, provided the rider's free hand remains behind the rein hand. Any attempt to alter tension or length of the reins from bridle to the rein hand is to be considered use of two hands a penalty score of zero will be applied. In addition, should the judge determine the free hand is being used to instill fear or praise, a penalty five will be applied, and a reduction in the maneuver score.

SHW482.I The following will result in a score of 0:

Use of more than index or first finger between reins;

Use of two hands (exception in junior, snaffle bit, or hackamore classes designated for two hands) or changing hands;

Use of romal other than as outlined in WESTERN EQUIPMENT

Failure to complete pattern as written:

Performing the maneuvers other than in specified order;

The inclusion of maneuvers not specified, including, but not limited to

Backing more than two strides

Turning more than 90 degrees

Equipment failure that delays completion of pattern; including dropping a rein that contacts the ground while horse is in motion.

Balking or refusal of command where performance is delayed;

Running away or failing to guide where it becomes impossible to discern whether the entry is on pattern;

Jogging in excess of one-half circle or one-half the length of the arena;

Overspins of more than 1/4 turn;

Fall to the ground by horse or rider

when going to and coming out of a rollback in a pattern requiring a run-around, a rollback that crosses the center line;

SHW483. Neither a no score nor a 0 are eligible to place in a go round or class, but a 0 may advance in a multi-go event while a no score may not.

SHW484. The following will result in a reduction of five points:

Spurring in front of cinch;

Use of either hand to instill fear or praise;

Holding saddle with either hand;

Blatant disobediences including kicking, biting, bucking, rearing and striking.

SHW485. The following will result in a reduction of two points:

Break of gait;

Freeze up in spins or rollbacks;

On walk-in patterns, failure to stop or walk before executing a canter departure.

On run-in patterns, failure to be in a canter prior to the first marker.

If a horse does not completely pass the specified marker before initiating a stop position.

SHW486. Starting or performing circles or eights out of lead will be judged as follows:

SHW486.1 Each time a horse is out of lead, a judge is required to deduct one point. The penalty for being out of lead is cumulative and the judge will deduct one penalty point for each quarter of the circumference of a circle or any part thereof that a horse is out of lead. A judge is required to penalize a horse 1/2 point for a delayed change of lead by one stride where the lead change is required by the pattern description.

SHW486.2 Deduct 1/2 point for starting circle at a jog or exiting rollbacks at a jog up to two strides. Jogging beyond two strides, but less than 1/2 circle or 1/2 the length of the arena, deduct two points.

SHW486.3 Deduct 1/2 point for over or under spinning up to 1/8 of a turn; deduct one point for over or under spinning 1/8 to 1/4 turn.

SHW486.4 A 1/2 point penalty deduction will be given for failure to remain a minimum of 20 feet (6 meters) from the wall or fence when approaching a stop and/or rollback.

SHW487. In patterns requiring a run-around, failure to be on the correct lead when rounding the end of the arena will be penalized as follows: for 1/2 the turn or less, one point; for more than 1/2 turn, two points.

SHW487.1 **In a pattern requiring a run-around, there will be a one half (1/2) point penalty for failure to remain a minimum of 10 feet from either side of the center of the arena; for small arenas it will be at the judge's discretion.**

SHW488. Faults against the horse to be scored accordingly, but not to cause disqualification:

- Opening mouth excessively when wearing bit;
- Excessive jawing, opening mouth or head raising on stop;
- Lack of smooth, straight stop on haunches-bouncing or side-ways stop;
- Refusing to change leads;
- Anticipating signals;
- Stumbling;
- Backing sideways;
- Knocking over markers.

SHW489. Faults against the rider to be scored accordingly, but not to cause disqualification:

- Losing stirrup;
- Failure to run circles or figure eights within the markers is not considered a fault depending on arena conditions and size; however, failure to go beyond markers on rollbacks and stops is considered a fault.

SHW490. A show may have up to three approved reining classes and no horse may be entered in both junior bit and hackamore/snaffle bit reining classes at the same show.

SHW490.1 If three reining classes are to be held at a show, they shall be the following:

SHW490.1.1 Senior reining shown with bit;

SHW490.1.2 Junior reining shown with bit;

SHW490.1.3 Hackamore/snaffle bit reining (5 years old and younger, shown with hackamore or snaffle bit)

SHW490.2 If two reining classes are to be held at a show, they shall be the following:

SHW490.2.1 Senior reining shown with bit;

SHW490.2.2 Junior reining shown with either bit, hackamore or snaffle bit at the discretion of the exhibitor.

SHW490.3 If only one reining class is to be held at a show, it shall be reining - all ages - horses 6 years old and older must be shown in bit; horses 5 years old and younger may be shown in either bit, hackamore or snaffle bit at the discretion of the exhibitor.

REINING PATTERN I

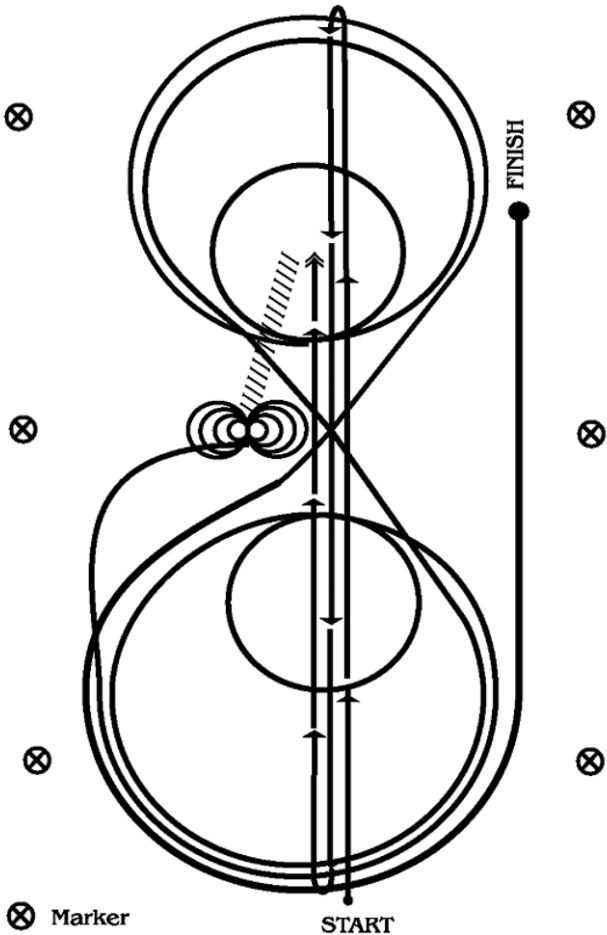

1. Run at speed to the far end of the arena past the end marker and do a left rollback - no hesitation.
2. Run to the opposite end of the arena past the end marker and do a right rollback - no hesitation.
3. Run past the center marker and do a sliding stop. Back up to center of the arena or at least 10 feet (3 meters). Hesitate.
4. Complete four spins to the right.
5. Complete four and one-quarter spins to the left so that horse is facing left wall or fence. Hesitate.
6. Beginning on the left lead, complete three circles to the left: the first circle large and fast; the second circle small and slow; the third circle large and fast. Change leads at the center of the arena.
7. Complete three circles to the right: the first circle large and fast; the second circle small and slow; the third circle large and fast. Change leads at the center of the arena.
8. Begin a large circle to the left but do not close this circle. Run straight up the right side of the arena past the center marker and do a sliding stop at least 20 feet (6 meters) from wall or fence. Hesitate to demonstrate the completion of the pattern.

Rider may drop bridle to the designated judge.

REINING PATTERN 2

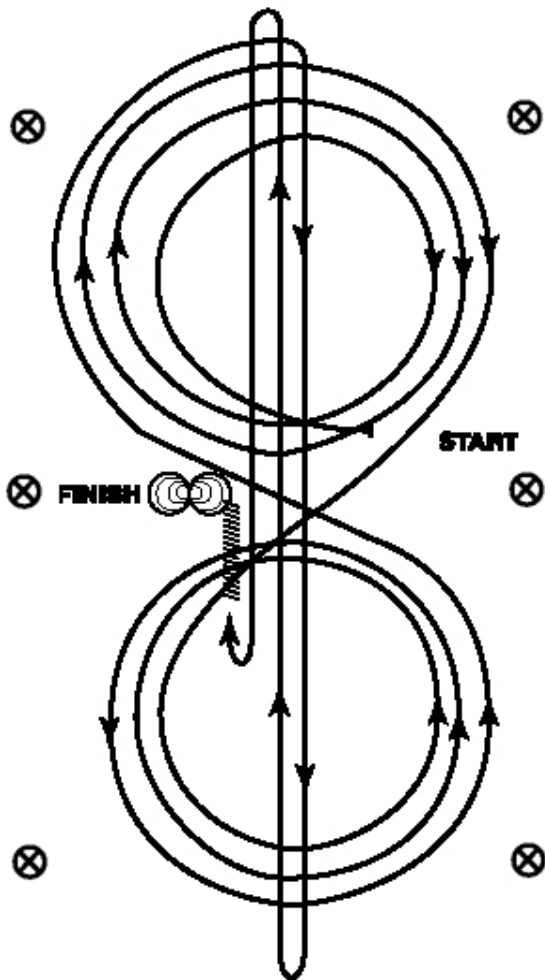

Horse must walk or stop prior to starting pattern.

Beginning at the center of the arena facing the left wall or fence.

1. Beginning on the right lead, complete three circles to the right: the first circle small and slow; the next two circles large and fast. Change leads at the center of the arena.
2. Complete three circles to the left: the first circle small and slow; the next two circles large and fast. Change leads at the center of the arena.
3. Continue around previous circle to the right. At the top of the circle, run down the middle to the far end of the arena past the end marker and do a right rollback - no hesitation.
4. Run up the middle to the opposite end of the arena past the end marker and do a left rollback - no hesitation.
5. Run past the center marker and do a sliding stop. Back up to the center of the arena or at least 10 feet (3 meters). Hesitate.
6. Complete four spins to the right.
7. Complete four spins to the left. Hesitate to demonstrate the completion of the pattern.

Rider may drop bridle to the designated judge.

REINING PATTERN 3

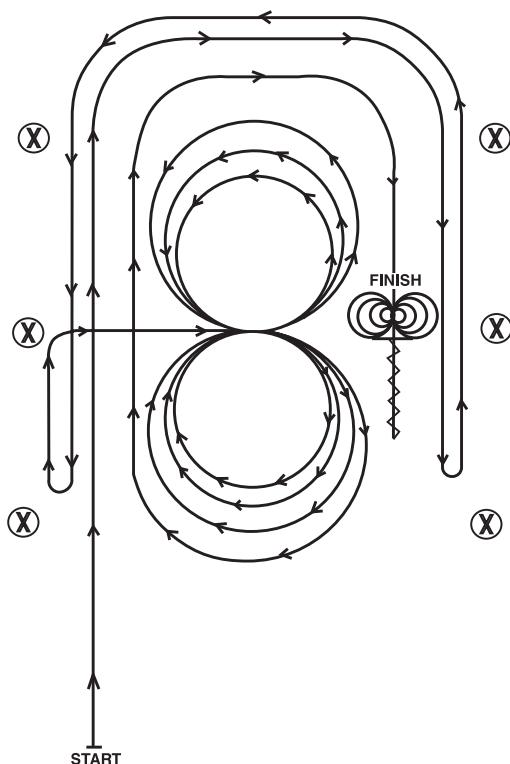

○ MARKER

1. Beginning, and staying at least 20 feet (6 meters) from the walls or fence, lope straight up the left side of the arena, circle the top end of the arena, run straight down the opposite or right side of the arena past the center marker and do a left rollback - no hesitation.
2. Continue straight up the right side of the arena staying at least 20 feet (6 meters) from the wall or fence, circle back around the top of the arena, run straight down the left side of the arena past the center marker and do a right rollback - no hesitation.
3. Continue up the left side of the arena to the center marker. At the center marker, the horse should be on the right lead. Guide the horse to the center of the arena on the right lead and complete three circles to the right: the first two circles large and fast; the third circle small and slow. Change leads at the center of the arena.
4. Complete three circles to the left: the first two circles large and fast; the third circle small and slow. Change leads in the center of the arena.
5. Begin a large circle to the right but do not close this circle. Continue up the left side of the arena staying at least 20 feet (6 meters) from the wall or fence, circle the top of the arena, run straight down the opposite or right side of the arena past the center marker and do a sliding stop. Back up at least 10 feet (3 meters). Hesitate.
6. Complete four spins to the right.
7. Complete four spins to the left. Hesitate to demonstrate completion of the pattern.

Rider may drop bridle to the designated judge.

REINING PATTERN 4

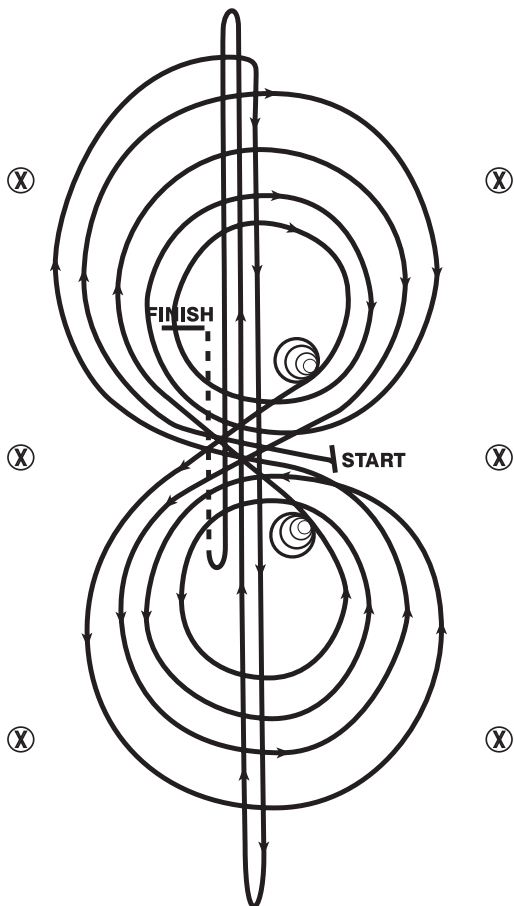

Horse must walk or stop prior to starting pattern.

Beginning at the center of the arena facing the left wall or fence.

1. Beginning on the right lead, complete three circles to the right: the first two circles large and fast; the third circle small and slow. Stop at the center of the arena.
2. Complete four spins to the right. Hesitate.
3. Beginning on the left lead, complete three circles to the left: the first two circles large and fast; the third circle small and slow. Stop at the center of the arena.
4. Complete four spins to the left. Hesitate.
5. Beginning on the right lead, run a large fast circle to the right, change leads at the center of the arena, run a large fast circle to the left, and change leads at the center of the arena.
6. Continue around previous circle to the right. At the top of the circle, run down the middle to the far end of the arena past the end marker and do a right rollback - no hesitation.
7. Run up the middle to the opposite end of the arena past the end marker and do a left rollback - no hesitation.
8. Run past the center marker and do a sliding stop. Back up to the center of the arena or at least 10 feet (3 meters). Hesitate to demonstrate completion of the pattern.

Rider may drop bridle to the designated judge.

REINING PATTERN 5

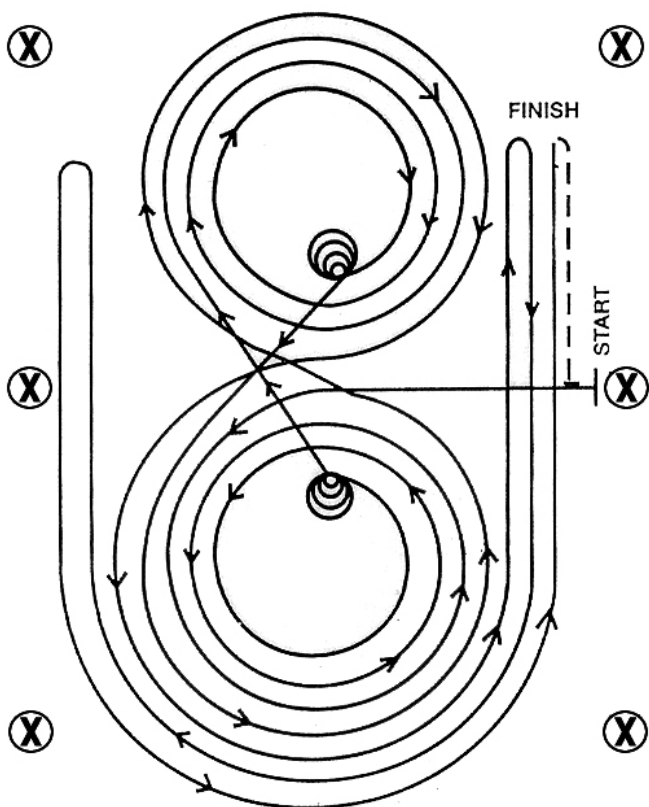

Horse must walk or stop prior to starting pattern.

Beginning at the center of the arena facing the left wall or fence.

1. Beginning on the left lead, complete three circles to the left: the first two circles large and fast; the third circle small and slow. Stop at the center of the arena.
2. Complete four spins to the left. Hesitate.
3. Beginning on the right lead, complete three circles to the right: the first two circles large and fast; the third circle small and slow. Stop at the center of the arena.
4. Complete four spins to the right. Hesitate.
5. Beginning on the left lead, run a large fast circle to the left, change leads at the center of the arena, run a large fast circle to the right, and change leads at the center of the arena. (Figure 8)
6. Continue around previous circle to the left but do not close this circle. Run up the right side of the arena past the center marker and do a right rollback at least 20 feet (6 meters) from the wall or fence - no hesitation.
7. Continue around previous circle but do not close this circle. Run up the left side of the arena past the center marker and do a left rollback at least 20 feet (6 meters) from the wall or fence - no hesitation.
8. Continue back around previous circle but do not close this circle. Run up the right side of the arena past the center marker and do a sliding stop at least 20 feet (6 meters) from the wall or fence. Back up at least 10 feet (3 meters). Hesitate to demonstrate completion of the pattern.

Rider may drop bridle to the designated judge.

REINING PATTERN 6

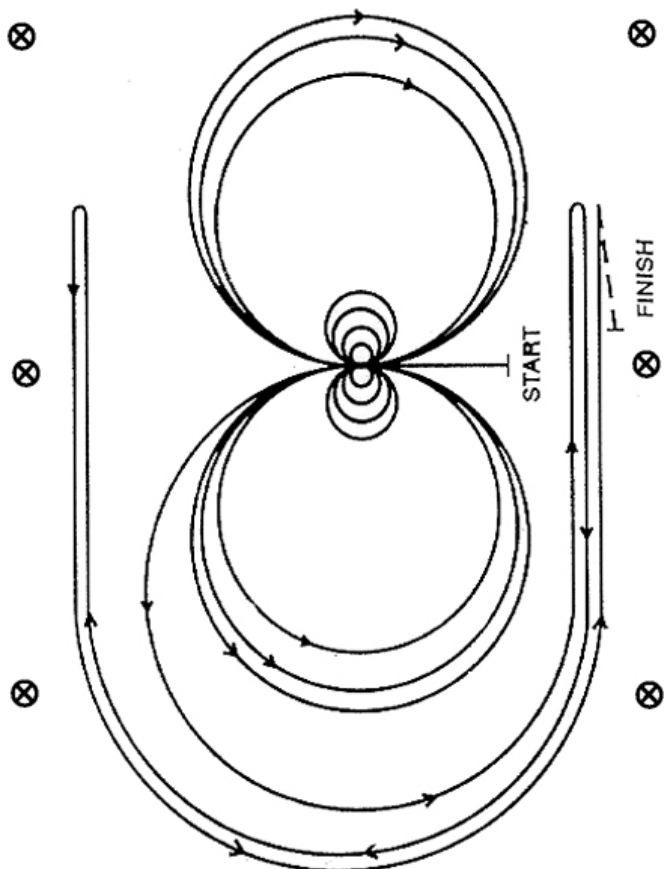

Horse must walk or stop prior to starting pattern.

Beginning at the center of the arena facing the left wall or fence.

1. Complete four spins to the right.
2. Complete four spins to the left. Hesitate.
3. Beginning on the left lead, complete three circles to the left: the first two circles large and fast; the third circle small and slow. Change leads at the center of the arena.
4. Complete three circles to the right: the first two circles large and fast; the third circle small and slow. Change leads at the center of the arena.
5. Begin a large circle to the left but do not close this circle. Run up the right side of the arena past the center marker and do a right rollback at least 20 feet (6 meters) from the wall or fence - no hesitation.
6. Continue back around previous circle but do not close this circle. Run up the left side of the arena past the center marker and do a left rollback at least 20 feet (6 meters) from the wall or fence - no hesitation.
7. Continue back around previous circle but do not close this circle. Run up the right side of the arena past the center marker and do a sliding stop at least 20 feet (6 meters) from the wall or fence. Back up at least 10 feet (3 meters). Hesitate to demonstrate the completion of the pattern.

Rider may drop bridle to the designated judge.

REINING PATTERN 7

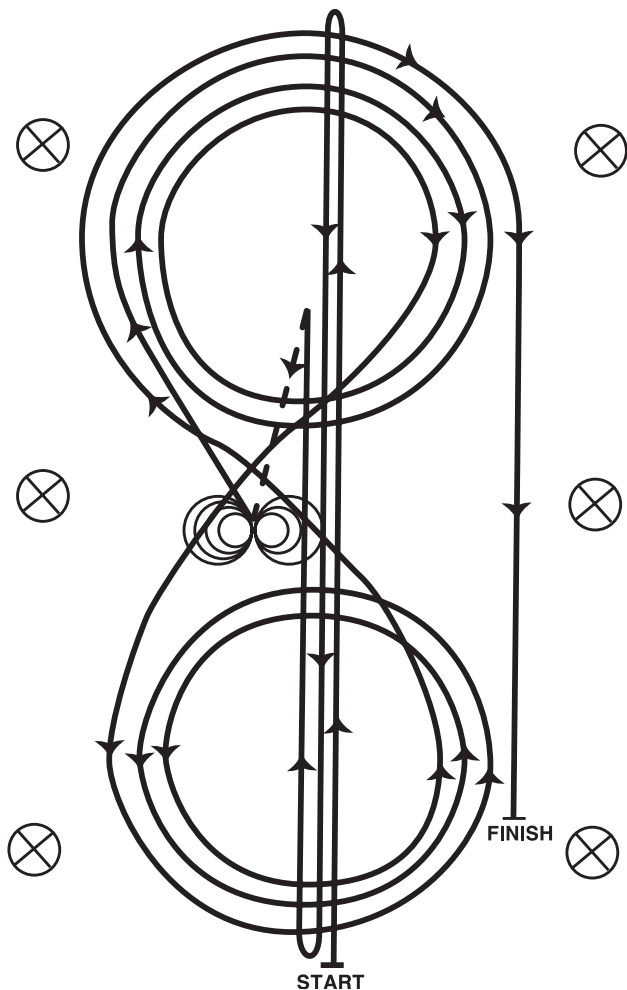

1. Run at speed to the far end of the arena past the end marker and do a left rollback - no hesitation.
2. Run to the opposite end of the arena past the end marker and do a right rollback - no hesitation.
3. Run past the center marker and do a sliding stop. Back up to the center of the arena or at least ten feet (3 meters). Hesitate.
4. Complete four spins to the right.
5. Complete four and one-quarter spins to the left so that horse is facing left wall or fence. Hesitate.
6. Beginning on the right lead, complete three circles to the right: the first two circles large and fast; the third circle small and slow. Change leads at the center of the arena.
7. Complete three circles to the left: the first two circles large and fast; the third circle small and slow. Change leads at the center of the arena.
8. Begin a large circle to the right but do not close this circle. Run straight down the right side of the arena past the center marker and do a sliding stop at least 20 feet (6 meters) from the wall or fence. Hesitate to demonstrate completion of the pattern.

Rider may drop bridle to the designated judge.

REINING PATTERN 8

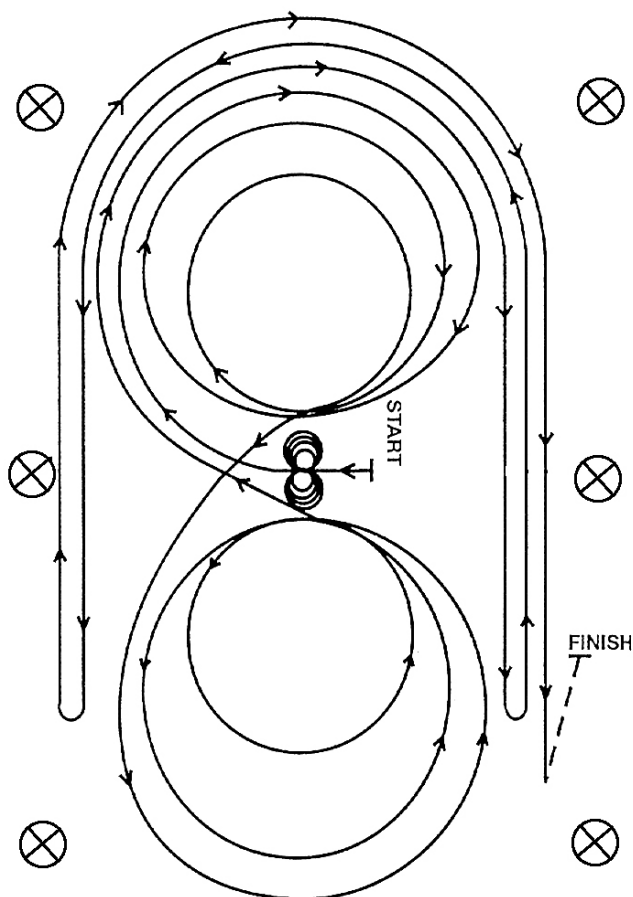

Horse must walk or stop prior to starting pattern.

Beginning at the center of the arena facing the left wall or fence.

1. Complete four spins to the left.
2. Complete four spins to the right. Hesitate.
3. Beginning on the right lead, complete three circles to the right: the first circle large and fast; the second circle small and slow; the third circle large and fast. Change leads at the center of the arena.
4. Complete three circles to the left: the first circle large and fast; the second circle small and slow; the third circle large and fast. Change leads at the center of the arena.
5. Begin a large circle to the right but do not close this circle. Run straight down the right side of the arena past the center marker and do a left roll-back at least 20 feet (6 meters) from the wall or fence - no hesitation.
6. Continue back around the previous circle but do not close this circle. Run down the left side of the arena past the center marker and do a right roll-back at least 20 feet (6 meters) from the wall or fence - no hesitation.
7. Continue back around the previous circle but do not close this circle. Run down the right side of the arena past the center marker and do a sliding stop at least 20 feet (6 meters) from the wall or fence. Back up at least 10 feet. Hesitate to demonstrate completion of the pattern.

Rider may drop bridle to the designated judge.

REINING PATTERN 9

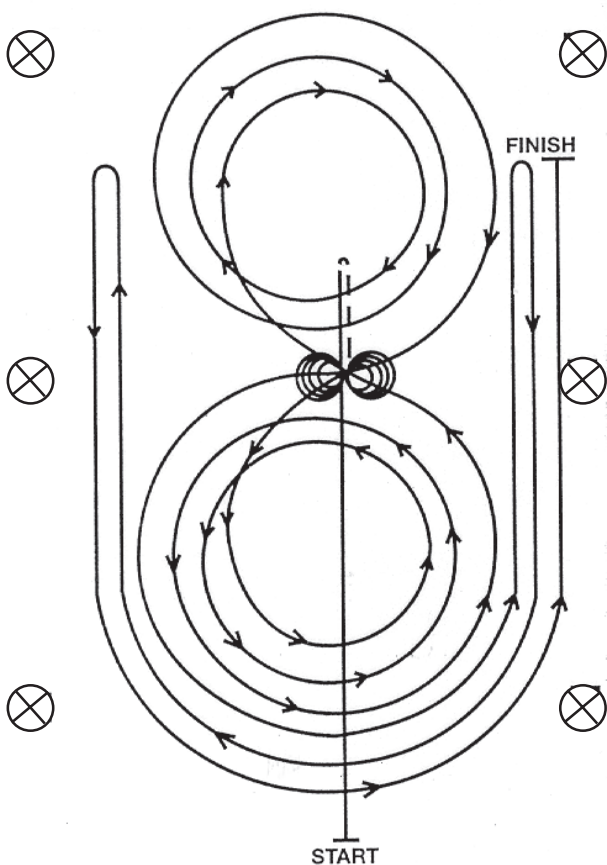

1. Run past the center marker and do a sliding stop. Back up to the center of the arena or at least 10 feet (3 meters). Hesitate.
2. Complete four spins to the right.
3. Complete four and one-quarter spins to the left so that horse is facing the left wall or fence. Hesitate.
4. Beginning on the left lead, complete three circles to the left: the first circle small and slow; the next two circles large and fast. Change leads at the center of the arena.
5. Complete three circles to the right: the first circle small and slow; the next two circles large and fast. Change leads at the center of the arena.
6. Begin a large circle to the left but do not close this circle. Run up the right side of the arena past the center marker and do a right rollback at least 20 feet (6 meters) from the wall or fence - no hesitation.
7. Continue back around the previous circle but do not close this circle. Run up the left side of the arena past the center marker and do a left rollback at least 20 feet (6 meters) from the wall or fence - no hesitation.
8. Continue back around previous circle but do not close this circle. Run up right side of the arena past the center marker and do a sliding stop at least 20 feet (6 meters) from the wall or fence. Hesitate to demonstrate completion of the pattern.

Rider may drop bridle to the designated judge.

REINING PATTERN 10

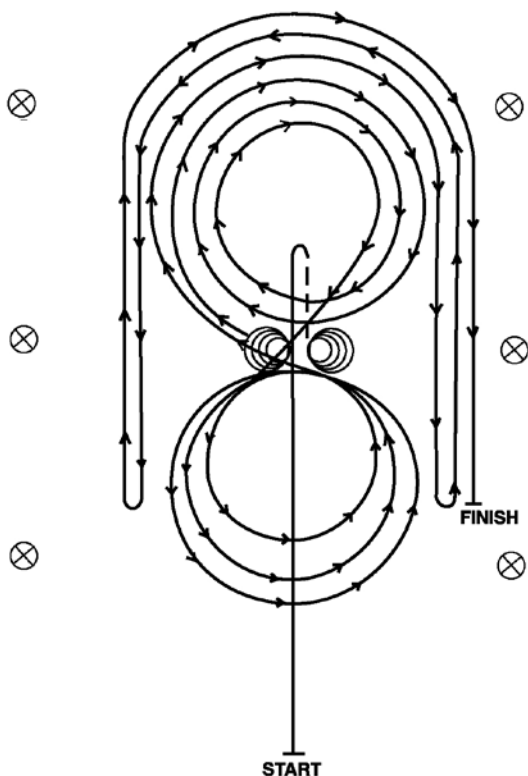

⊗ **MARKER**

1. Run past the center marker and do a sliding stop. Back up to the center of the arena or at least 10 feet (3 meters). Hesitate.
2. Complete four spins to the right.
3. Complete four and one-quarter spins to the left so that the horse is facing the left wall or fence. Hesitate.
4. Beginning on the right lead, complete three circles to the right: the first two circles large and fast, the third circle small and slow. Change leads at the center of the arena.
5. Complete three circles to the left: the first circle small and slow, the next two circles large and fast. Change leads at the center of the arena.
6. Begin a large circle to the right but do not close this circle. Run down the right side of the arena past the center marker and do a left rollback at least 20 feet (6 meters) from the wall or fence - no hesitation.
7. Continue back around the previous circle but do not close this circle. Run down the left side of the arena past the center marker and do a right rollback at least 20 feet (6 meters) from the wall or fence - no hesitation.
8. Continue back around previous circle but do not close this circle. Run down the right side of the arena past the center marker and do a sliding stop at least 20 feet (6 meters) from the wall or fence. Hesitate to demonstrate completion of the pattern.

Rider may dismount and drop the bridle to the designated judge.

REINING PATTERN II

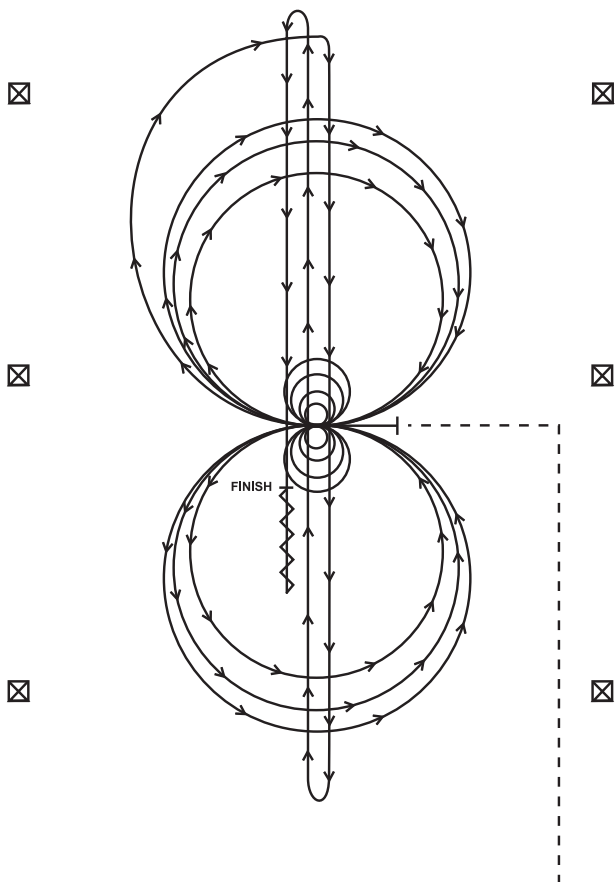

Horses must jog the majority of the way to the center. Failure to jog the majority of the way to the center will result in a 0 for failure to complete the pattern as written. Horses must walk or stop prior to starting pattern. Beginning at the center of the arena facing the left wall or fence.

1. Complete four spins to the left. Hesitate.
2. Complete four spins to the right. Hesitate.
3. Beginning on the right lead, complete three circles to the right; the first circle small and slow; the next two circles large and fast. Change leads at the center of the arena.
4. Complete three circles to the left; the first circle small and slow; the next two circles large and fast. Change leads at the center of the arena.
5. Begin a large circle to the right, but do not close this circle. Run down the center of the arena past the end marker and do a right rollback - no hesitation.
6. Run up the middle to the opposite end of the arena past the end marker and do a left rollback - no hesitation.
7. Run past the center marker and do a sliding stop. Back up to the center of the arena or at least 10 feet (3 meters). Hesitate to demonstrate completion of the pattern.

REINING PATTERN 12

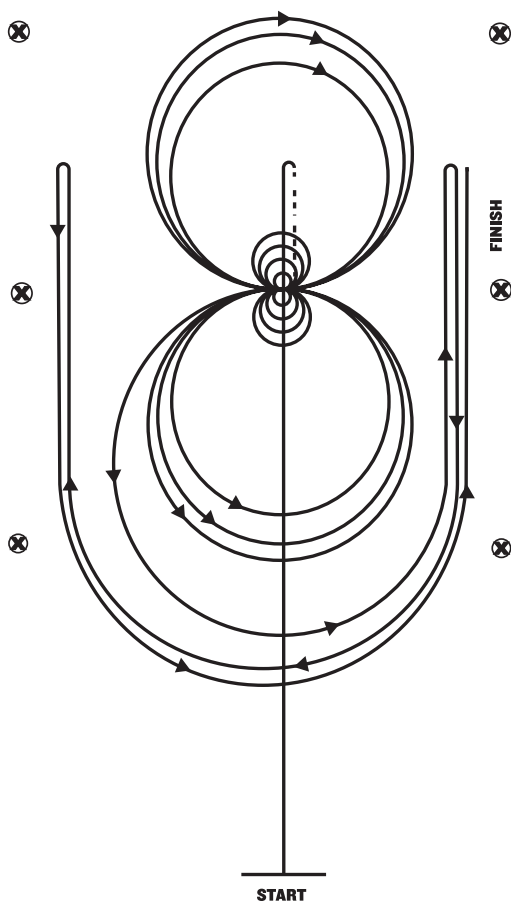

1. Run past the center marker and do a sliding stop. Back up to the center of the arena or at least 10 feet (3 meters). Hesitate.
2. Complete four spins to the right.
3. Complete four and one-quarter spins to the left so that the horse is facing the left wall or fence. Hesitate.
4. Beginning on the left lead, complete three circles to the left: the first two circles large and fast; the third circle small and slow. Change leads at the center of the arena.
5. Complete three circles to the right: the first two circles large and fast; the third circle
6. Begin a large fast circle to the left but do not close the circle. Run up the right side of the arena past the center marker and do a right rollback at least 20 feet (6 meters) from the wall or fence—no hesitation.
7. Continue back around previous circle but do not close the circle. Run up the left side of the arena and past the center marker and do a left rollback at least 20 feet (6 meters) from the wall or fence—no hesitation.
8. Continue back around previous circle but do not close this circle. Run up the right side of the arena past the center marker and do a sitting stop at least 20 feet (6 meters) from the wall or fence.

Rider may drop bridle to the designated judge.

REINING PATTERN 13

??

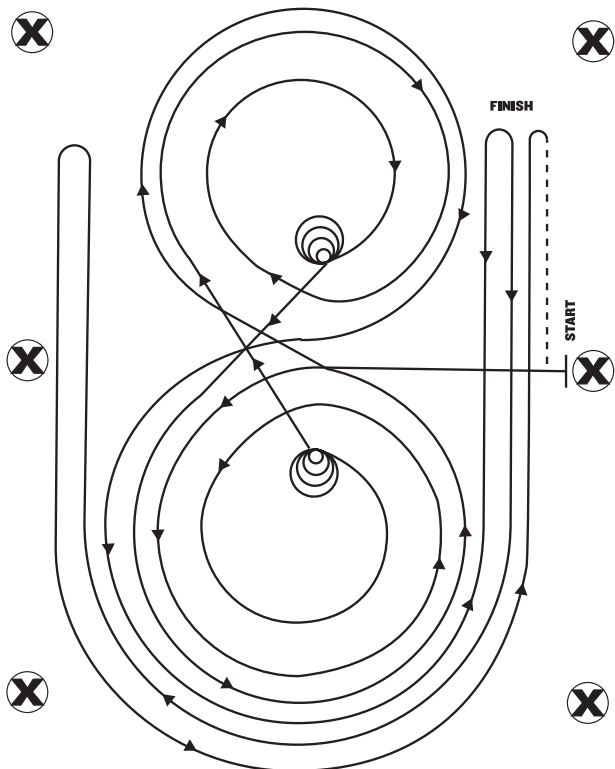

Horses must walk or stop prior to starting pattern.

Beginning at the center of the arena facing the left wall or fence.

1. Beginning on the left lead, complete two circles to the left: the first circle large and fast; the second circle small and slow. Stop at the center of the arena.
2. Complete four spins to the left. Hesitate
3. Beginning on the right lead, complete two circles to the right: the first being large and fast; the second circle small and slow. Stop at the center of the arena.
4. Complete four spins to the right. Hesitate
5. Beginning on the left lead, run a large fast circle to the left, change leads at the center of the arena, run a large fast circle to the right, and change leads at the center of the arena.
6. Continue around previous circle to the left but do not close this circle. Run up the right side of the arena past the center marker and do a right rollback at least 20 feet (6 meters) from the wall or fence-no hesitation
7. Continue around previous circle but do not close this circle. Run up the left side of the arena past the center marker and do a left rollback at least 20 feet (6 meters) from the wall or fence-no hesitation.
8. Continue back around previous circle but do not close this circle. Run up the right side of the arena past the center marker and do a sliding stop at least 20 feet (6 meters) from the wall or fence. Back up at least 10 feet (3 meters).

Hesitate to demonstrate completion of the pattern.

Rider may drop bridle to the designated judge.

REINING PATTERN 14

Approved only for Level I Youth and Amateur, Youth 13 & Under and EWD
Jog, Lope Para-reining (Independent)

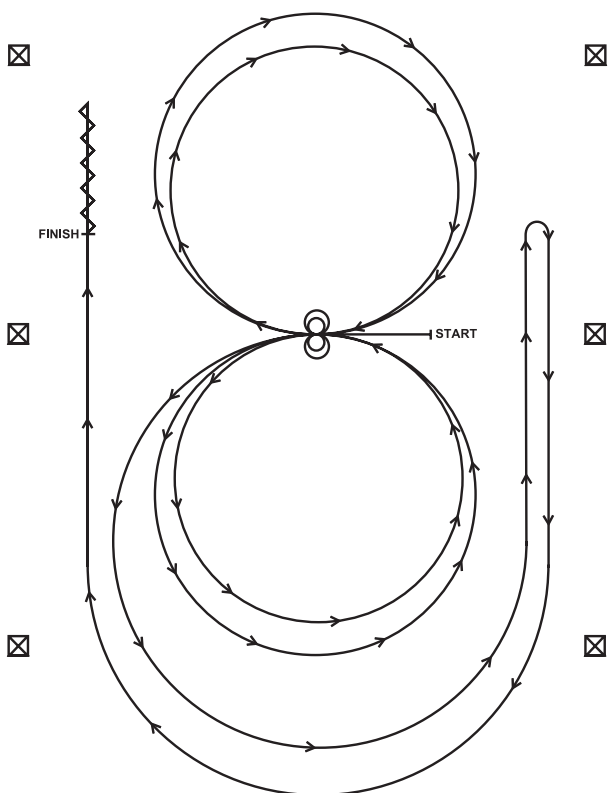

Horses may walk or trot to the center of the arena. Horses must walk or stop prior to starting the pattern. Beginning at the center of the arena facing the left wall or fence.

1. Beginning on the left lead, complete two circles to the left. Stop at the center of the arena. Hesitate.
2. Complete two spins to the left. Hesitate
3. Beginning on the right lead complete two circles to the right. Stop at the center of the arena. Hesitate.
4. Complete two spins to the right. Hesitate.
5. Beginning on the left lead, go around the end of the arena, run down the right side of the arena past center marker, stop and roll back right.
6. Continue around the end of the arena to run down the left side of the arena past the center marker. Stop. Back up.

Hesitate to show completion of pattern.

REINING PATTERN 15

Approved only for Level I Youth and Amateur, Youth 13 & Under and EWD Jog, Lope Para-reining (Independent)

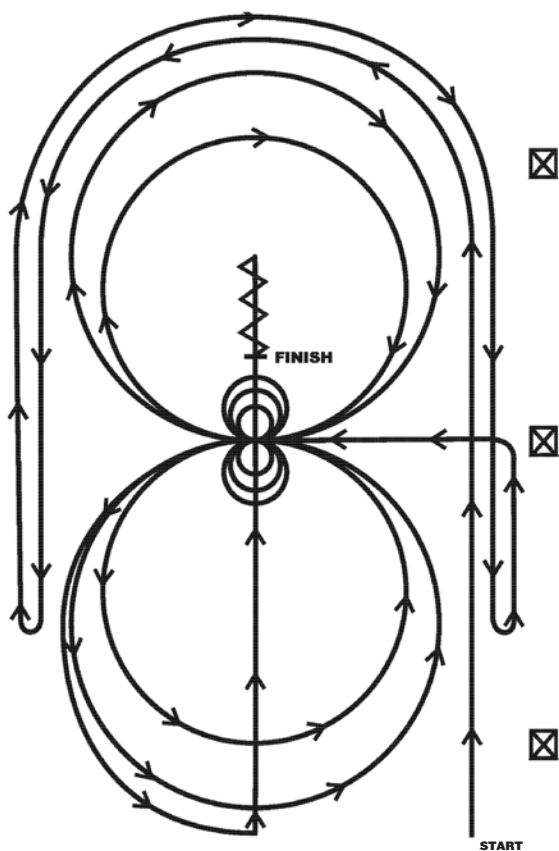

1. Run around the end of the arena, run down the left side past center marker, right rollback
2. Run around end of arena, run down right side past center marker, left rollback
3. Left circles, one large fast and one small slow, stop at center
4. 3 spins left, hesitate
5. Right circles, one large fast and one small slow, stop at center
6. 3 spins right, hesitate
7. Begin large circle to left at the top of the circle, run down the center of arena past center marker, stop and back up at least 10 feet.

Hesitate to show completion of pattern.

SHW500. CUTTING. The cutting class is a battle of wills between a horse and a cow. Horse and rider must move quietly into a herd of cattle, cut one animal from the herd, drive it to the center of the arena and hold it away from the herd. The cutting horse must match moves with the cow, anticipating its every maneuver. Judges score the horses on their ability to keep the cow from returning to the herd, cow sense, attentiveness and courage. Contestants can cut two or more head of cattle in the 2.5-minute time limit. AQHA strongly recommends AQHA-approved cutting classes be held whenever possible. If both NCHA and AQHA-approved cutting are held at one show, points will be awarded only in the AQHA-approved cutting classes. National Cutting Horse Association or Canadian Cutting Horse Association rules will be used for conducting and judging cutting. All riders in the arena shall comply with rules on dress, equipment and conduct and be limited to bona fide contestants or their helpers per NCHA rules.

SHW500.1 Rules of the National Cutting Horse Association are available from the National Cutting Horse Association, 260 Bailey Avenue, Fort Worth, Texas 76107.

SHW500.2 Rules of the Canadian Cutting Horse Association are available from the Canadian Cutting Horse Association, 14141 Fox Drive, Edmonton, Alberta, Canada T6H 4P3.

SHW501. For NCHA-approved cutting, AQHA points shall be awarded only on the basis of the signed records of the show or contest, forwarded to AQHA by show management providing:

SHW501.1 Horses competed under their AQHA registered name,

SHW501.2 Exhibitors must have current AQHA membership in their individual name,

SHW501.3 The competition was held in conjunction with an AQHA-approved show, and no AQHA-approved cutting classes were held at that show.

SHW502. Scoring. Scoring will be on the basis of 60-80, with 70 denoting an average performance.

SHW503. Penalties. A contestant will be penalized per occurrence as follows:

SHW503.1 One-Half (1/2) point

a slight miss or slight loss of working advantage

SHW503.2 One (1) point

miss or loss of working advantage

reining or visibly cueing

noise, directed toward cattle

toe, foot or stirrup on shoulder of horse

holding on too long on a cut

working out of position

hand too far forward

SHW503.3 Three (3) points

hot quit

cattle picked up or scattered

second hand on the reins

spur in the shoulder

pawing or biting cattle

failure to make a deep cut

back fence

SHW503.4 Five (5) points

horse quitting a cow

losing a cow

changing cattle after a specific commitment

failure to separate a single animal after leaving the herd

SHW503.5 Score of 60 if horse turns tail

SHW503.6 Disqualified (0) – Score

illegal equipment

leaving working area before time expires

inhumane treatment of horse

riding with romal or closed rein on snaffle bit/hackamore

if horse falls to ground

SHW505. WORKING COW HORSE. The Working Cow Horse class is based on the traditional vaquero training techniques used to develop the most highly schooled of all cow horses, the bridle horse. The training begins in a snaffle bit, progresses to a hackamore and then the two-rein on the way to the bridle. This method of training, which takes years rather than months, is geared to helping a horse reach his maximum level of performance, from the working ranch to the competitive arena. Both the cow work portion of this event and the reined work portion are mandatory. Scoring emphasis on the cow work portion shall be based on the horse maintaining control of the cow at all times, exhibiting superior cow sense and natural cow working ability without excessive reining or spurring. The greater the difficulty of the run, the more credit should be given. The difficulty may be due to the extreme speed or stubbornness of the cow, or the cow's reluctance to move down the fence when sufficiently driven by the contestant. The most controlled cow work with the highest degree of difficulty should be marked the highest. Failure of an exhibitor to attempt to complete the cow work portion of the class, as well as the reined work, will result in the exhibitor not being considered an entry in the class. A horse that attempts to complete the cow work and has not been disqualified will be scored accordingly at the judge's discretion. A horse going off pattern in the reined work will receive a score of zero. A horse that attempts both the reined work and the cow work portion may be placed, even if disqualified in one portion of the class. (Example: If a horse is disqualified and receives a 0 score for the reined work, but scores a 70 for the cow work, its total score would be a 70 and the horse would be eligible for placing.) However, the fall of a horse and rider being judged shall be cause for disqualification and not eligible to be placed.

SHW505.1 The approved pattern will be used and each contestant will cause his horse to travel at the gait indicated for each part of the pattern. When judging reined work, the judge should refer to the reining portion of the rulebook for guidelines with the addition of a one point penalty for scotching or anticipating a stop.

SHW505.2 In approved working cow horse classes, any of the twelve approved AQHA working cow horse patterns may be used. One of the twelve is to be selected by the judge of the class and used by all contestants in the class. All trot-in patterns may be modified to lope-in patterns. When selecting a lope-in pattern, judges should take into consideration the direction of the exhibitor's approach to the arena center so the horse can be on the correct lead from the gate to the start of the patterns. Rider will walk through the gate and, without trotting, pick up the correct lead and continue loping to the center of arena. At the center, without stopping or breaking gait, begin pattern. When using a lope to the center pattern, judging of the pattern will begin at the center of arena. Penalties occurring while loping to the center of arena to begin pattern will be assessed.

SHW505.3 For an ideal cow work, each contestant, upon receiv-

ing a cow in the arena, shall hold the cow on the prescribed end of the arena for sufficient time to demonstrate the ability of the horse to contain the cow on that end. After a reasonable amount of time, the contestant shall take the cow down the fence, making at least one turn each way on the fence. The contestant shall then take the cow to an open part of the arena and circle it at least once in each direction. The required pattern for the cow work is boxing, fence turns and circles, in that order. It is the judge's responsibility to control the pen and treatment of all cattle.

SHW505.4 The judge should take into consideration the size of the arena, condition of ground and the disposition and degree of difficulty exhibited by the cattle worked.

SHW505.5 At the discretion of the judge, cow work may be done immediately following each individual's pattern work or immediately after completion of pattern work by all horses being exhibited.

SHW505.6 The judge may blow his/her whistle at any time during the work. One whistle to terminate the work, two whistles to award a new cow. If the judge awards a new cow, the exhibitor has the option to refuse the new cow by continuing to work. If the exhibitor intends to accept the new cow, he or she must pull up immediately. If at any time a judge feels that the contestant is out of control endangering themselves and/or their horse, the judge may terminate the work, and a score of zero will be given. In the case of an emergency (Such as a person falling into the arena or part of the arena falling apart) the judge may blow two whistles for a second time. At this point, the contestant has no option to continue and must receive a new cow. Contestant must pull up immediately or a score of zero will be given. Judging ends when the whistle blows. A score of zero will be given if the work is not complete at that point.

SHW505.7 If time and number of cattle permit, the judge may, at his discretion, award new cattle, to enable the contestant to show his horse's ability on the cow, based on the following criteria:

SHW505.7.1 the cow won't or can't run;

SHW505.7.2 the cow won't leave the end of the arena;

SHW505.7.3 the cow is blind or won't yield to the horse;

SHW505.7.4 the cow leaves the arena.

SHW506. SCORING. Scoring will be on the basis of 60-80, with 70 denoting an average performance. The same basis of scoring shall apply to both the reined work and cow work. In the event of a tie, the entry with the highest cow work will be declared the winner.

Penalties should be assessed, per occurrence, as follows for fence work

SHW506.1 One (1) point

Loss of working advantage

Horses that run past the cow shall be penalized one point for every horse's length past the cow, when the horse's buttocks pass the cow's head by one horse's length, he is one length past

Failure to drive cow past middle marker on first turn before turning cow

Each time the arena is crossed to use the opposite fence to achieve a turn

Using the corner or the end of the arena to turn the cow when going down the fence

Slipping a rein

Excessive whipping, spurring or hollering

SHW506.2 Two (2) points

Going past the corner of the arena before turning the cow when going down the fence

In an open field turn, animal gets within three feet of the end fence before being turned

On trot-in patterns, failure to stop before executing a canter departure.

SHW506.3 Three (3) points

Knocking down the cow without having a working advantage

Hanging up on the fence (refusing to turn)

Exhausting or overworking the cow before circling

SHW506.4 Five (5) points

Not getting one turn each way (five points each way)

Deliberate spurring or use of the romal forward of the cinch

Blatant disobedience

SHW506.5 Score - 0

Turn tail

Using two hands on the reins in a bridle or two-rein class

Fingers between the reins in a bridle class, except the two-rein class

Balking

Out of control

Bloody mouth (inside)

Illegal equipment

Leaving working area before pattern is complete

Fall of horse or rider

Schooling between rein work and cow work

Schooling horse between cows, if new cow is awarded.

If a rider hits or kicks the animal being worked, with the romal or reins, in an abusive manner.

Failure to quit working a cow after a new cow has been awarded.

If a rider intentionally kicks or hits the animal being worked in an abusive manner

SHW507. The characteristics of the horse considered faults include:

exaggerated opening of mouth

hard or heavy mouth

nervous throwing of head

lugging on bridle

halting or hesitation while being shown, particularly when being run out, indicating anticipation of being set up

losing a cow or being unable to finish a pattern because of a bad cow, the contestant should be penalized at the judge's discretion

SHW508. The characteristics of a good working cow horse include:

good manners

shifty, smooth and having its feet under it at all times; when stopping, hind feet should be well under it

a soft mouth and should respond to a light rein, especially when turning head should be maintained in its natural position

work at reasonable speed and still be under control of the rider

SHW509. A show may have up to three approved working cow horse classes. No horse may be entered in both junior bit and hackamore/snaffle bit working cow horse classes at the same show;

SHW509.1 If three working cow horse classes are held at a show they shall be the following:

SHW509.1.1 senior working cow horse shown with bit

SHW509.1.2 junior working cow horse shown with bit

SHW509.1.3 hackamore/snaffle bit working cow horse (Horses 5 years of age and under as of January 1 of current show year, may be shown in either a snaffle bit or hackamore.)

SHW509.1.4 NRCHA rules allow for a spade bit or a bit having the following characteristics; one with an unbroken bar mouthpiece with one inch or higher port measured from the bottom of the bar to the top of the port. There must be an operable cricket or roller (with single for multiple rings) incorporated within the mouthpiece of the bit. It is legal to have a barrel, made of copper or metal, wrapped around the bar space of the bit and is to be considered a part of the mouthpiece. The barrel must be round, smooth, and made up of one continuous, unbroken piece. The minimum diameter, on any part of the bar of the mouthpiece, is 5/16 inch. Bars must be round, oval or egg shaped smooth and unwrapped metal. Latex wrap or any foreign material is not acceptable. Nothing may protrude below the mouthpiece (bar), such as extensions or prongs. The cheeks must be connected at the bottom. The overall length of the bit shall not be longer than 8 1/2 inches measured from the inside bottom of the top of headstall ring to point of pull in the bottom ring. Optional tongue release shall not exceed three inches in width.

SHW509.1.5 The hackamore shall be round in shape and constructed of uniform braided rawhide or leather and have a non-metal flexible core. No gimmick of any kind may be used in conjunction with the bosal. No rigid material of any kind may be used, regardless of how padded or covered, in conjunction with the bosal. Horse hair bosals are prohibited. Tape is not allowed on the noseband of the hackamore. Smooth, flat, wrapped tape is allowed on the hackamore between the headstall and the mecate reins. Maximum amount of tape allowed is two inches on each side of the hackamore.

SHW509.1.6 the use of 'two rein equipment' is allowed as recognized by our NRCHA alliance in AQHA working cow horse. The purpose of the two rein option is the transition between the hackamore and bridle and can be used on any aged horse in the amateur, junior, senior or all age working cow horse class, or VRH reining and cow work, or amateur boxing for one year only. The bit and bosal combination must be approved in accordance with NRCHA rules, below. Only one hand may be used on the reins and hands must not be changed. Any number of fingers between reins will be permitted. Both mecate and bridle reins are to be held in the rein hand.

SHW509.1.7 In the two rein class, bosals may be of any size, constructed of braided rawhide or leather and have a non-metal flexible core. No iron or foreign substance may be used. The rider must use one hand on the reins. Fingers between the reins will be permitted. Both mecate and bridle reins are to be held in the rein hand.

SHW509.2 If two working cow horse classes are to be held at a show, they shall be the following:

SHW509.2.1 senior working cow horse shown with bit

SHW509.2.2 junior working cow horse shown with either a bit, hackamore or snaffle bit at the discretion of the exhibitor

SHW509.3 If only one working cow horse class is to be held at a show, it shall be working cow horse - all ages - horses 6 years old and older must be shown in bit while horses 5 years old and younger may be shown in either bit, hackamore or snaffle bit at the discretion of the exhibitor.

SHW510. BOXING. Boxing consists of a reining pattern and single cow work (boxing) on the end of the arena. The goal of this class is to introduce the rider to the "boxing" phase of the cow work. Judging begins when the contestant enters the arena. There shall be no schooling between the completion of the rein work and the cow work, or between cows if a new cow is awarded. The penalty for this is -0-. Each contestant upon receiving a cow in the arena, shall hold that cow on the prescribed end of the arena for 50 seconds, demonstrating the ability of the horse and rider to control the cow. It is legal to hold the reins and romal in one hand (rein hand) while boxing the cow. Time shall begin when the gate closes behind the cow after being let into the arena. The announcer or judge will signal the completion of the 50 seconds with a whistle or horn.

SHW510.1 Offered for Level I amateur, amateur, Select, Level I youth and youth.

SHW510.1.1 A youth rider is eligible for I3 and under, I4-I8 and Level I youth boxing classes if they have never been a finalist in working cow horse at any AQHA world championship show or NRCHA major event and if they have earned less than 25 points in working cow horse.

SHW510.1.2 A rider is eligible for Select, amateur and Level I amateur boxing classes if they have never been a finalist in working cow horse at any AQHA world championship show or NRCHA major event and if they have earned less than 25 points in working cow horse in the last three years. Any amateur or Select rider can fall back one time to the boxing. After they have returned to the boxing class, if that rider then shows down the fence one time they are permanently ineligible for the boxing class.

SHW510.1.3 If a rider is eligible to compete in boxing at the beginning of that calendar year, the rider will lose his or her eligibility to enter boxing if he or she shows three or more times down the fence in any judged class. Being entered in a class that includes the fence work will be counted as going down the fence, regardless if the rider boxed the cow and pulled up before the run was completed. There will be no cross entering (i.e. if you enter boxing, you cannot enter the corresponding working cow horse class.)

SHW511. SCORING. Scoring will be on the basis of 60-80, with 70 denoting an average performance. The same basis of scoring shall apply to both the reined work and the boxing work. In the event of a tie, the entry with the highest cow work will be declared the winner. The judge may blow the whistle at any time to terminate the work. A score of zero will be given if the work is not complete at that time. Each work will be limited to 50 seconds and, the judge may request additional work at his/her option.

SHW512. Credits

- maintaining control of the cow at all times
- maintaining proper position
- degree of difficulty
- eye appeal

time worked

SHW513. Penalties should be assessed, per occurrence, as follows for the boxing/cow work:

SHW513.1 One (1) point

loss of working advantage
working out of position

SHW513.2 Three (3) points

loss of control and cow leaves end of arena

SHW513.3 Five (5) points

Spurring or hitting in front of cinch at anytime
Blatant disobedience defined as kicking, biting, bucking, rearing, striking or obviously insubordinate

SHW513.4 Score - 0

Turn tail
Using two hands on the reins in a bridle or the two-rein
Fingers between the reins in a bridle class, except in the two-rein
Balking
Out of control
Bloody mouth (inside)
Illegal equipment
Leaving working area before pattern is complete
Fall of horse or rider
Schooling between rein work and cow work
Schooling between cows, if new cow is awarded
Failure to quit working a cow after a new cow has been awarded.

OVAL ARENA

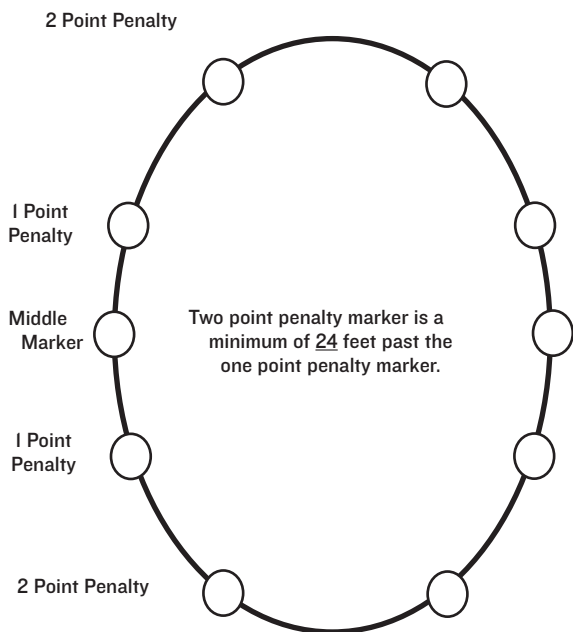

SQUARE ARENA

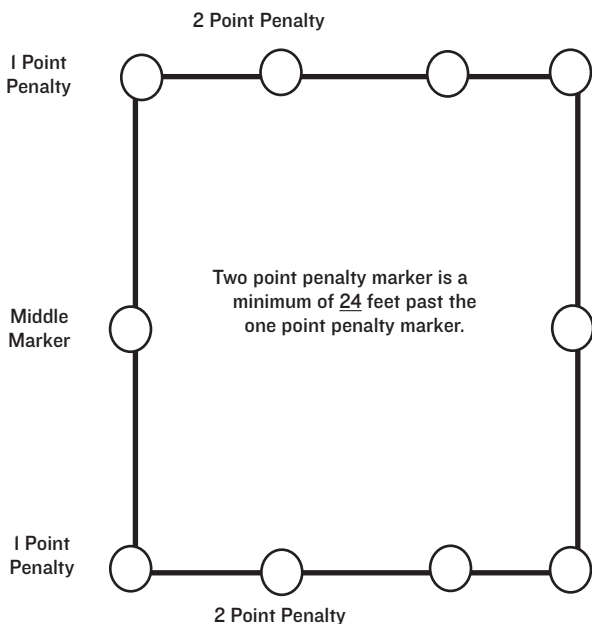

WORKING COW HORSE PATTERN 1

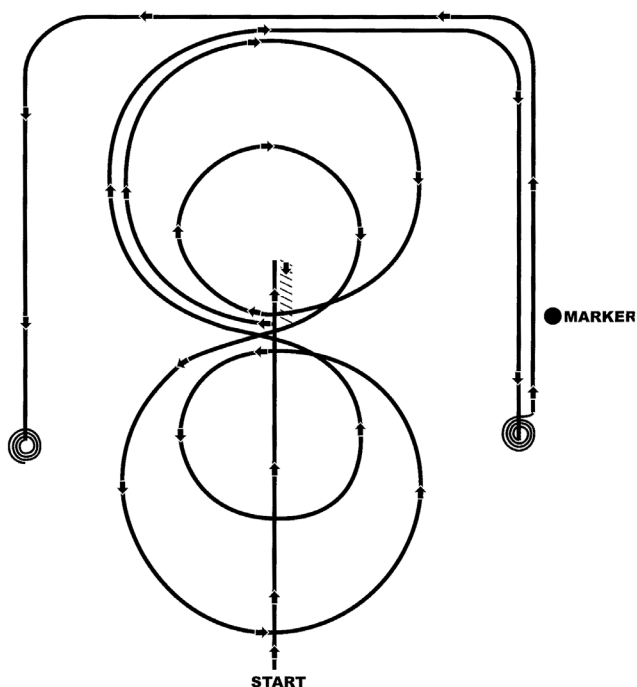

PATTERN 1

1. Start at end of arena. Run down middle past center marker to a sliding stop.
2. Back at least 10 feet to center. $1/4$ turn to left.
3. Pick up right lead, large fast circle, small slow circle.
4. Change leads to left, large fast circle, small slow circle.
5. Change leads to right, do not close this circle.
6. Run around end of arena and down the side (approximately 20 feet from fence) past center marker and come to a sliding stop.
7. Complete $3 \frac{1}{2}$ spins to the right.
8. Continue back down side and end of arena to other side (approximately 20 feet from fence) go past center marker and come to a sliding stop.
9. Complete $3 \frac{1}{2}$ spins to the left.
10. Hesitate to complete pattern.

Pattern 1

- | | |
|------------------------------------|--------------------------------|
| 1. Stop and back up and $1/4$ turn | 4. Stop |
| 2. Right circles | 5. $3 \frac{1}{2}$ right spins |
| 3. Left circles | 6. Stop |
| | 7. $3 \frac{1}{2}$ left spins |

WORKING COW HORSE PATTERN 2

Mandatory Marker Along Fence or Wall

Trot to center of arena and stop. Start pattern facing toward judge.

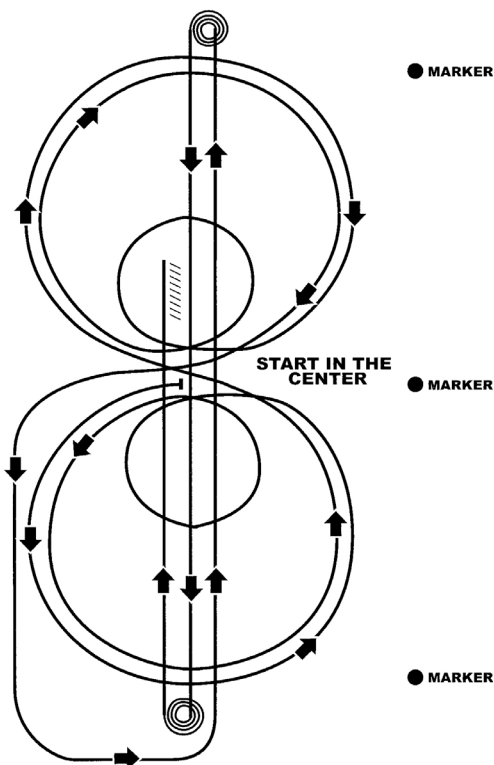

1. Pick up left lead, complete three circles to the left. The first one large and fast, the second small and slow, the third large and fast.
2. Change leads at center of arena.
3. Complete three circles to the right. The first one large and fast, the second small and slow, the third large and fast.
4. Change leads at center of arena.
5. Do not stop, continue on to run downs.
6. Run to far end past the marker to a sliding stop. Hesitate
7. Complete 3 1/2 spins to the left. Hesitate.
8. Run to far end past the marker to a sliding stop. Hesitate
9. Complete 3 1/2 spins to the right. Hesitate.
10. Run past center marker to a sliding stop. Hesitate.
11. Back at least 10 feet in a straight line. Hesitate
12. Hesitate to complete pattern.

Pattern 2

- | | |
|------------------|----------------------|
| 1. Left circles | 4. 3 1/2 left spins |
| 2. Right circles | 5. Stop |
| 3. Stop | 6. 3 1/2 right spins |
| | 7. Stop and back up |

This pattern may be used as a lope in pattern; refer to SHW505.2.

WORKING COW HORSE PATTERN 3

Mandatory Marker Along Fence or Wall

Trot to center of arena and stop. Start pattern facing toward judge.

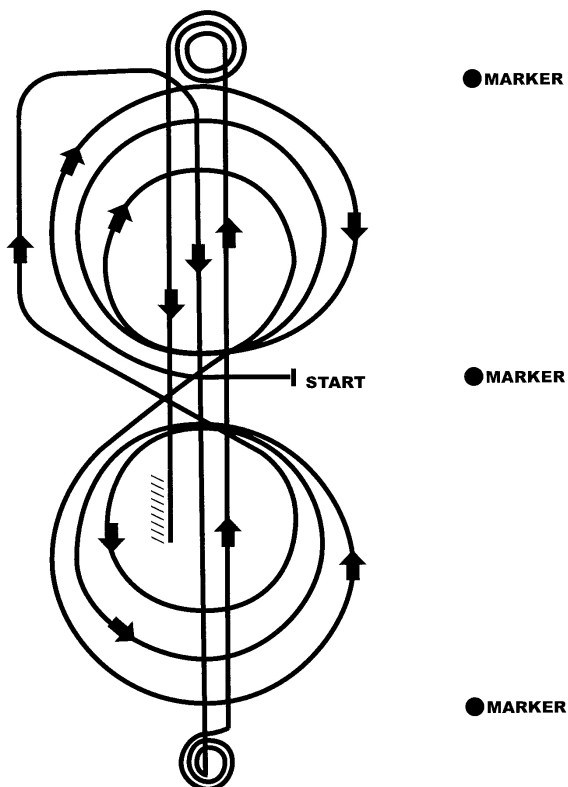

1. Begin on right lead and complete three circles to right, two large fast circles followed by one small slow circle, change to left lead.
2. Complete three circles to left, two large, fast circles followed by one small slow circle. Change to right lead.
3. Continue loping around end of arena without breaking gait.
4. Run up center of arena to far end past the end marker and come to a sliding stop.
5. Complete 3 1/2 spins to the right.
6. Run up center of arena past the end marker, come to a sliding stop.
7. Complete 3 1/2 spins to the left.
8. Run back to middle of the arena past the center marker and come to a sliding stop.
9. Back at least 10 feet in a straight line.
10. Hesitate to complete pattern.

Pattern 3

- | | |
|------------------|----------------------|
| 1. Right circles | 4. 3 1/2 right spins |
| 2. Left circles | 5. Stop |
| 3. Stop | 6. 3 1/2 left spins |
| | 7. Stop and back up |

This pattern may be used as a lope in pattern; refer to SHW505.2.

WORKING COW HORSE PATTERN 4

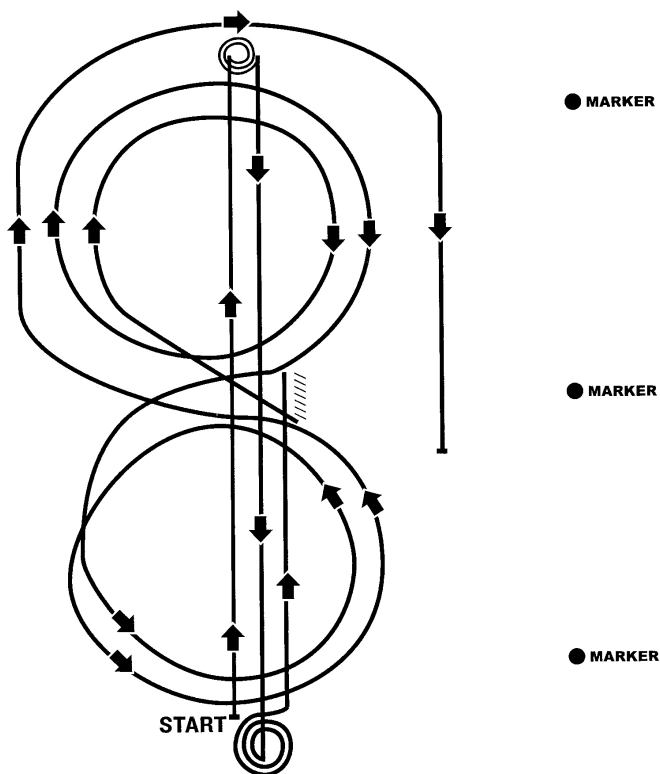

1. Start at end of arena.
2. Run up center of arena past the end marker and come to a sliding stop. Complete 3 1/2 spins to the left.
3. Run to other end of arena past the end marker and stop. Complete 3 1/2 spins to the right.
4. Run past the center marker and stop.
5. Back at least 10 feet in a straight line.
6. Complete 1/4 turn to the left, hesitate. Begin on right lead. Circle to the right. Complete two circles to the right, the first one small and slow and the second large and fast. Change leads at the center of the arena.
7. Complete one small, slow circle and one large, fast circle. Change leads to the right.
8. Run around end of arena to the other side, past the center marker, at least 20 feet from fence and come to a sliding stop.
9. Hesitate to complete pattern.

Pattern 4

- | | |
|----------------------|-----------------------------------|
| 1. Stop | 5. Stop and back up and 1/4 turn |
| 2. 3 1/2 left spins | 6. Right circles and left circles |
| 3. Stop | 7. Stop |
| 4. 3 1/2 right spins | |

WORKING COW HORSE PATTERN 5

This pattern works best when the exhibitor and cattle enter from the same end of arena.

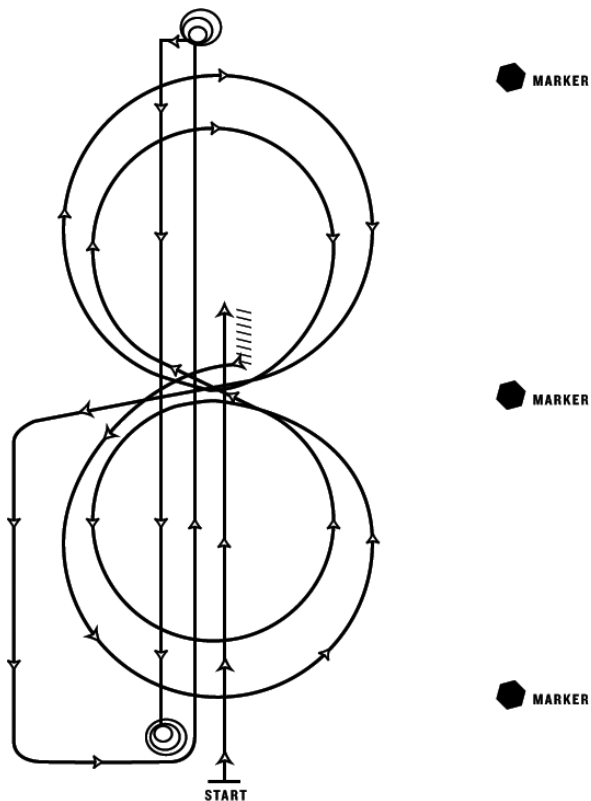

1. Start at end of arena.
2. Run past the center marker and stop.
3. Back up at least 10 feet.
4. Complete 1/4 turn to the left.
5. Complete 2 circles to the left, the first one large and fast and the second small and slow. Change leads at the center of the arena.
6. Complete two circles to the right, the first one small and slow, the second large and fast. Change leads at the center of the arena.
7. Continue around end of arena without breaking gait or changing leads, run down center of arena past end marker, come to a square sliding stop.
8. Complete 3 1/2 spins to the right.
9. Run down center of arena past end marker and come to a square sliding stop.
10. Complete 3 1/2 spins to the left.
11. Hesitate to complete pattern.

Pattern 5

- | | |
|----------------------------------|----------------------|
| 1. Stop and back up and 1/4 turn | 4. Stop |
| 2. Left circles | 5. 3 1/2 right spins |
| 3. Right circles | 6. Stop |
| | 7. 3 1/2 left spins |

WORKING COW HORSE PATTERN 6

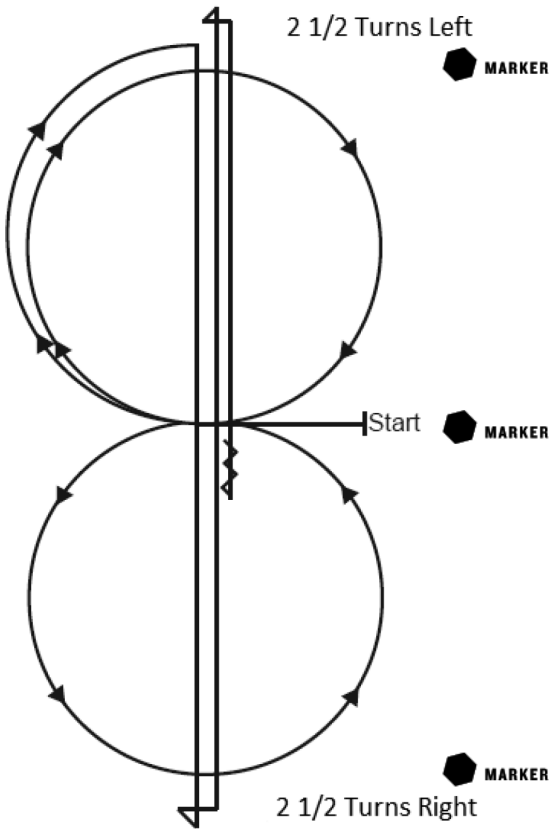

Trot to center of arena, stop. Start pattern facing towards judge

1. Beginning on the right lead lope one circle to the right. Change leads to the left.
2. Complete one circle to the left. Change leads to the right and go to the top of the arena.
3. Run down center of arena past the end marker and come to a sliding stop.
4. Complete 2 1/2 spins to the right.
5. Run to the other end of the arena, past the end marker and come to a sliding stop.
6. Complete 2 1/2 spins to the left.
7. Run past the center marker, stop, back at least 10 feet.

Hesitate to complete pattern

- | | |
|------------------------|-----------------------------|
| Pattern 6 | 4. 2 1/2 right spins |
| 1. Right circle | 5. Stop |
| 2. Left circle | 6. 2 1/2 left spins |
| 3. Stop | 7. Stop and back up |

This pattern may be used as a lope-in pattern; refer to SHW505.2.

WORKING COW HORSE PATTERN 7

Trot to center of arena and stop. Start pattern facing toward judge.

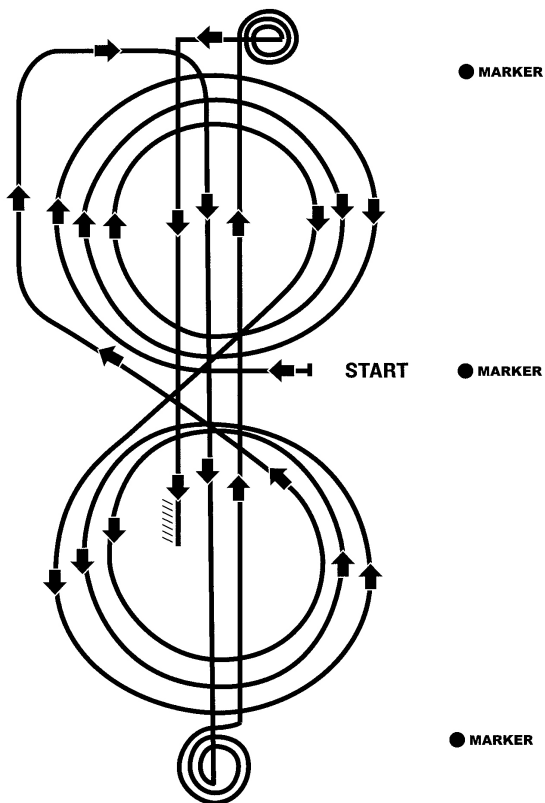

1. Begin at center of arena. Pick up right lead and complete three circles, the first large, fast, the second small, slow, the third large, fast. Change leads to the left.
2. Complete three circles: the first large and fast; the second small and slow; the third large and fast. Change leads to the right.
3. Continue loping around end of arena without breaking gait or changing leads.
4. Run down center of arena, past end marker and come to a sliding stop. Hesitate.
5. Complete 3 1/2 spins to the right.
6. Run down center of arena past end marker and come to a sliding stop. Hesitate.
7. Complete 3 1/2 spins to the left.
8. Run past center marker and come to a sliding stop.
9. Back up at least 10 feet.
10. Hesitate to complete pattern.

Pattern 7

- | | |
|----------------------|---------------------|
| 1. Right circles | 5. Stop |
| 2. Left circles | 6. 3 1/2 left spins |
| 3. Stop | 7. Stop and back up |
| 4. 3 1/2 right spins | |

WORKING COW HORSE PATTERN 8

Trot to center of arena and stop. Start pattern facing toward judge.

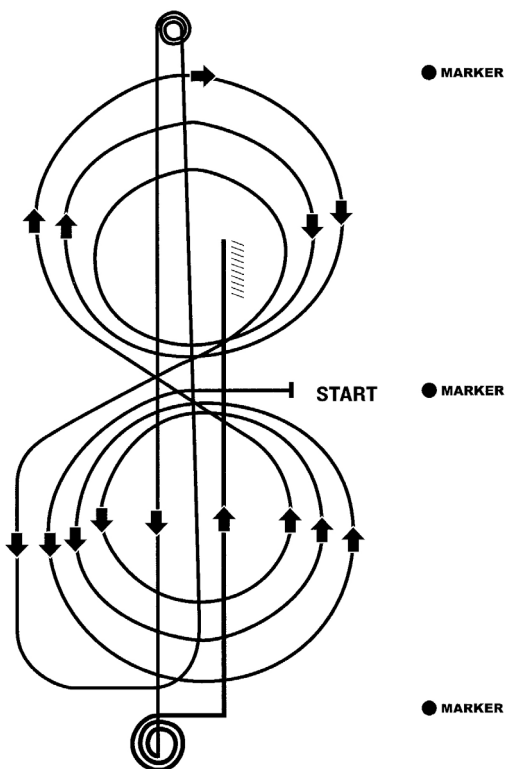

1. Beginning on the left lead complete three circles: two big fast circles; then one small slow circle. Change leads to the right.
2. Complete three circles to the right: two large fast circles, then one small slow circle. Change leads to the left.
3. Continue around end of arena without breaking gait or changing leads, run down center of arena past end marker, come to a square sliding stop.
4. Complete 3 1/2 spins to the left.
5. Run down center of arena past end marker and come to a square sliding stop.
6. Complete 3 1/2 spins to the right.
7. Run down center of arena past center marker and come to a square sliding stop.
8. Back up at least 10 feet.
9. Hesitate to complete pattern.

Pattern 8

- | | |
|------------------|----------------------|
| 1. Left circles | 4. 3 1/2 left spins |
| 2. Right circles | 5. Stop |
| 3. Stop | 6. 3 1/2 right spins |
| | 7. Stop and back up |

This pattern may be used as a lope-in pattern; refer to SHW505.2.

WORKING COW HORSE PATTERN 9

Trot to center of arena, stop. Start pattern facing toward judge.

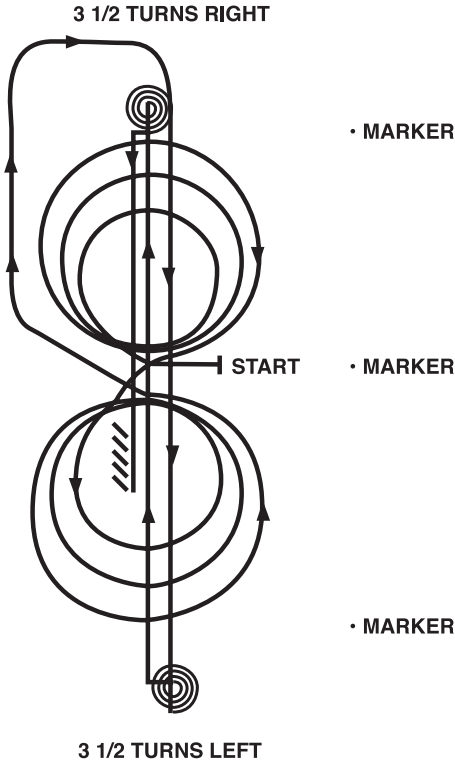

1. Beginning on the right lead complete 3 circles to the right; the first circle small and slow followed by two large fast circles. Change leads at the center of the arena.
2. Complete 3 circles to the left, the first circle small and slow followed by two large fast circles. Change leads at the center of the arena.
3. Continue around end of arena without breaking gait or changing leads, run down center of arena past end marker, and execute a square sliding stop.
4. Complete 3 1/2 spins to the left.
5. Run down center of arena past end marker, and execute a square sliding stop.
6. Complete 3 1/2 spins to the right.
7. Run down center of arena past center marker, and execute a square sliding stop.
8. Back up at least 10 feet.
9. Hesitate to complete pattern.

Pattern 9

- | | |
|------------------|----------------------|
| 1. Right circles | 4. 3 1/2 left spins |
| 2. Left circles | 5. Stop |
| 3. Stop | 6. 3 1/2 right spins |
| | 7. Stop and back up |

This pattern may be used as a lope-in pattern; refer to SHW505.2.

WORKING COW HORSE PATTERN 10

3 1/2 TURNS RIGHT

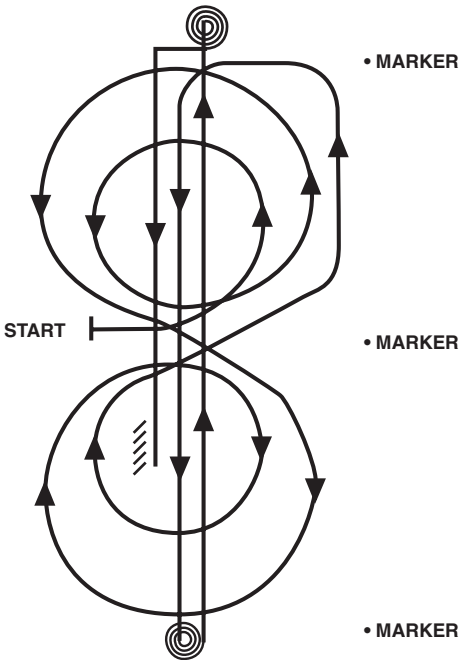

3 1/2 TURNS LEFT

Trot to center of arena, stop. Start pattern facing away from judge.

1. Beginning on the left lead, complete 2 circles to the left; the first circle small and slow, the second circle large and fast.
2. Complete 2 circles to the right; the first circle large and fast, the second circle small and slow. Change leads at the center of arena.
3. Continue around end of arena without breaking gait or changing leads, run down center of arena past end marker, and execute a square sliding stop.
4. Complete 3 1/2 spins to the left.
5. Run down center of arena past end marker, and execute a square sliding stop.
6. Complete 3 1/2 spins to the right.
7. Run down center of arena past center marker, and execute a square sliding stop.
8. Back up at least 10 feet.
9. Hesitate to complete pattern.

Pattern 10

- | | |
|------------------|----------------------|
| 1. Left circles | 4. 3 1/2 left spins |
| 2. Right circles | 5. Stop |
| 3. Stop | 6. 3 1/2 right spins |
| | 7. Stop and back up |

This pattern may be used as a lope-in pattern; refer to SHW505.2.

WORKING COW HORSE PATTERN II

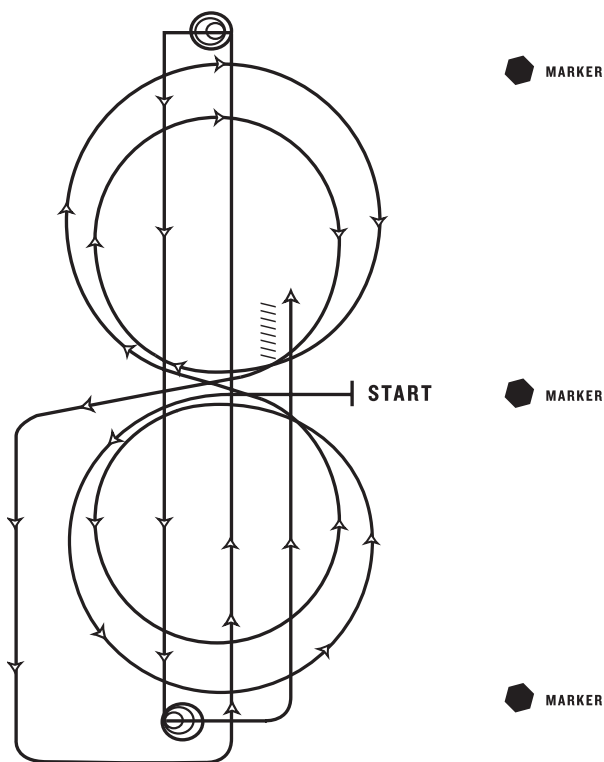

Trot to center of arena, stop. Start pattern facing towards judge

1. Beginning on the left lead, complete 2 circles to the left; the first circle large and fast, the second circle small and slow. Change leads at the center of the arena.
2. Complete 2 circles to the right; the first circle large and fast, the second circle small and slow. Change leads at the center of arena.
3. Continue around end of arena without breaking gait or changing leads, run down center of arena past end marker, and execute a square sliding stop.
4. Complete 3 1/2 spins to the left.
5. Run down center of arena past end marker, and execute a square sliding stop.
6. Complete 3 1/2 spins to the right.
7. Run down center of arena past center marker, and execute a square sliding stop.
8. Back up at least 10 feet.
9. Hesitate to complete pattern.

Pattern II

- | | |
|------------------|----------------------|
| 1. Left circles | 4. 3 1/2 left spins |
| 2. Right circles | 5. Stop |
| 3. Stop | 6. 3 1/2 right spins |
| | 7. Stop and back up |

This pattern may be used as a lope-in pattern; refer to SHW505.2.

WORKING COW HORSE PATTERN 12

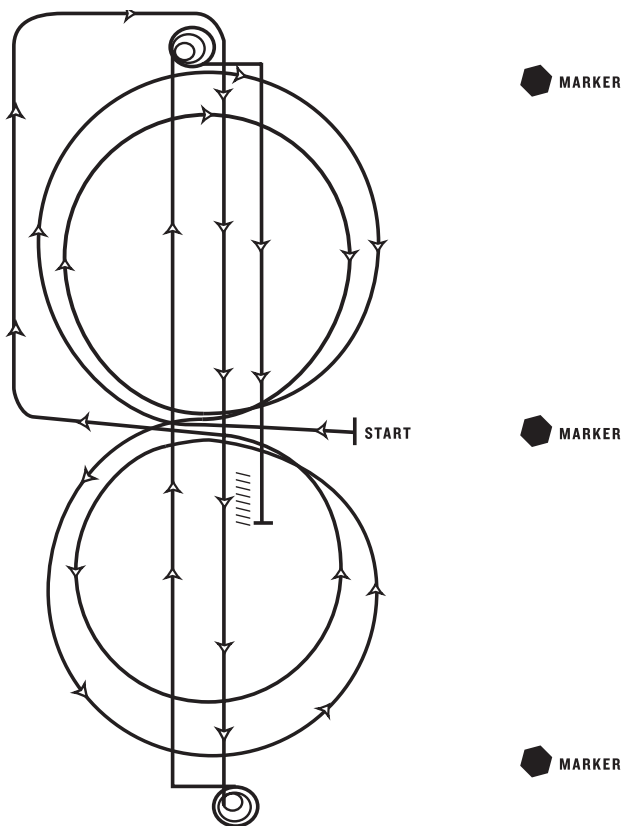

Trot to center of arena, stop. Start pattern facing toward judge.

1. Beginning on the right lead complete 2 circles to the right; the first circle large and fast and the second small and slow. Change leads at the center of the arena.
2. Complete 2 circles to the left, the first circle large and fast and the second small and slow. Change leads at the center of the arena.
3. Continue around end of arena without breaking gait or changing leads, run down center of arena past end marker, and execute a square sliding stop.
4. Complete 3 1/2 spins to the left.
5. Run down center of arena past end marker, and execute a square sliding stop.
6. Complete 3 1/2 spins to the right.
7. Run down center of arena past center marker, and execute a square sliding stop.
8. Back up at least 10 feet.
9. Hesitate to complete pattern.

Pattern 12

- | | |
|------------------|----------------------|
| 1. Right circles | 4. 3 1/2 left spins |
| 2. Left circles | 5. Stop |
| 3. Stop | 6. 3 1/2 right spins |
| | 7. Stop and back up |

This pattern may be used as a lope-in pattern; refer to SHW505.2.

The Working Cow Horse patterns are divided into sets of seven maneuver groups, which are scored as described below. These patterns break down as follows:

Pattern 1

1. Stop and back up and 1/4 turn
2. Right circles
3. Left circles
4. Stop
5. 3 1/2 right spins
6. Stop
7. 3 1/2 left spins

***Pattern 2**

1. Left circles
2. Right circles
3. Stop
4. 3 1/2 left spins
5. Stop
6. 3 1/2 right spins
7. Stop and back up

***Pattern 3**

1. Right circles
2. Left circles
3. Stop
4. 3 1/2 right spins
5. Stop
6. 3 1/2 left spins
7. Stop and back up

Pattern 4

1. Stop
2. 3 1/2 left spins
3. Stop
4. 3 1/2 right spins
5. Stop and back up and 1/4 turn
6. Right circles and left circles
7. Stop

Pattern 5

1. Stop and back up and 1/4 turn
2. Left circles
3. Right circles
4. Stop
5. 3 1/2 right spins
6. Stop
7. 3 1/2 left spins

***Pattern 6**

1. Right circle
2. Left circle
3. Stop
4. 2 1/2 right spins
5. Stop
6. 2 1/2 left spins
7. Stop and back up

***Pattern 7**

1. Right circles
2. Left circles
3. Stop
4. 3 1/2 right spins
5. Stop
6. 3 1/2 left spins
7. Stop and back up

***Pattern 8**

1. Left circles
2. Right circles
3. Stop
4. 3 1/2 left spins
5. Stop
6. 3 1/2 right spins
7. Stop and back up

***Pattern 9**

1. Right circles
2. Left circles
3. Stop
4. 3 1/2 left spins
5. Stop
6. 3 1/2 right spins
7. Stop and back up

***Pattern 10**

1. Left circles
2. Right circles
3. Stop
4. 3 1/2 left spins
5. Stop
6. 3 1/2 right spins
7. Stop and back up

***Pattern 11**

1. Left circles
2. Right circles
3. Stop
4. 3 1/2 left spins
5. Stop
6. 3 1/2 right spins
7. Stop and back up

***Pattern 12**

1. Right circles
2. Left circles
3. Stop
4. 3 1/2 left spins
5. Stop
6. 3 1/2 right spins
7. Stop and back up

*This pattern may be used as a lope-in pattern; refer to SHW505.2.

SHW520. ROPING EVENTS. The purpose of an AQHA roping class is to provide an opportunity for the horse to demonstrate and be judged on its natural talent and ability, its willingness to perform, and the level of training that makes it suitable for competitive timed roping events outside the AQHA arena. The rope horse will be evaluated through a series of individually judged maneuvers that when combined result in a score that most accurately exemplifies that rope horse's ability to allow its rider to catch and handle a calf and/or steer most efficiently and effectively.

SHW520.1 Horses must start from the roping box.

SHW520.2 Tie down roping and heading horses only (whether being judged or not) in dally team roping must start from behind a barrier (an electronic barrier is acceptable).

SHW520.3 Only the horse's performance, including manners behind the barrier and at all other times, is to be judged.

SHW520.4 The contestant shall not attempt to rope the animal until the barrier flag has been dropped. Any attempt by a contestant to position his horse behind the barrier enabling the contestant to rope the animal without attempting to leave the box shall be disqualified.

SHW520.5 Breaking the barrier, or any unnecessary whipping, jerking reins, talking or any noise making, slapping, jerking rope or any unnecessary action to induce the horse to perform better, will be considered a fault and scored accordingly.

SHW520.6 Participation in jackpots paid on time in roping events must be at the contestant's option.

SHW520.7 In all roping events, a run must be completed within a one-minute time limit.

SHW520.8 All heading and heeling cattle shall be protected by horn wraps.

SHW521. The judge may at his discretion award new cattle to enable contestant to show his horse's ability on the cow including:

SHW521.1 The cow won't run or stops

SHW521.2 Chute or barrier malfunctions

SHW521.3 Cow turns back immediately

SHW521.4 Cow leaves arena

SHW522. LEGAL CATCHES. Whether being judged or not, legal catches are required by both the header and heeler.

SHW522.1 Legal catches in heading are both horns, half-head and around the neck.

SHW522.2 Legal catches for heeling include a catch that holds from behind the steer's shoulders and back, around the flank, or on one or both heels.

SHW522.3 Any figure-eight, front leg, or the tip of a horn is not a legal heading catch.

SHW522.4 A tail only is not a legal heeling catch.

SHW525. TIE-DOWN ROPING. The roper may throw only two loops and must be done so within a one-minute time limit. The one-minute time limit is from the time the calf leaves the chute until the roper signals the time is complete. Although the time limit stops when the roper signals the tie is complete, the horse will continue to be judged until the rider has mounted the horse and ridden forward.

SHW525.1 In open division competition, if more than one loop is thrown, the roper must carry a second rope tied to the saddle, and this rope must be used for the second loop.

SHW525.2 Youth or amateurs who desire to throw the second

loop, may recoil rope or use a second rope tied to saddle.

SHW525.3 If the roper fails to catch, he will retire from the arena with no score.

SHW525.4 Any catch that holds is legal, but rope must remain on calf until tie is completed and roper has mounted horse.

SHW525.5 If calf is not standing when roper reaches calf, the roper must re-throw calf by hand, crossing any three feet, and tie with not less than one complete wrap and a half hitch. In Select amateur classes only the Select roper will not be required to re-throw the calf. In amateur classes, a Select amateur exhibitor must re-throw the calf.

SHW525.6 Rope must be run through a foul rope around the horse's neck, and may, at the discretion of the rider, be run through a "keeper". If a keeper is used, it must be attached to the noseband of the tie-down but never in front of the head stall and cannot be attached to the bridle or bit.

SHW525.7 Only the roper may touch the calf while the horse is being judged. Roper may dismount from either side and leg or flank calf.

SHW526. SCORING. Scoring will be on the basis of 0-100, with 70 denoting an average performance. Each maneuver will be scored from a plus three to a minus three, in 1/2 point increments.

SHW526.I The tie-down roping horse will be judged on four different maneuvers:

- box and barrier
- running and rating
- stop
- working the rope

SHW527. Penalties. Deductions will be assessed as follows:

SHW527.1 One (1) point

- dragging the calf will be penalized one point for each three feet moved up to 12 feet.

SHW527.2 Two (2) points

- freeze-up in the box (refusing to move)
- jumping the barrier
- setting up or scotching
- rubbing the rope
- failure to continue backing while roper is flanking the calf
- slack in the rope

SHW527.3 Three (3) points

- a two-loop run

SHW527.4 Five (5) points

- refusing to enter the box
- rearing in the box
- breaking the barrier
- running into the calf
- horse walking up the rope (rope on ground)
- blatant disobedience including kicking, biting, bucking, rearing and striking

SHW527. 5 Disqualified (0) – Score

- failure of calf to stay tied until roper has remounted and ridden forward to loosen rope.
- excessive schooling at any time in the arena.
- whipping or hitting the horse with the rope.
- initiating the run with the rope on the opposite side of the horse's neck than exhibitor's roping hand.

dragging the calf, while being tied or after the calf is tied, more than 12 feet.

any attempt by a contestant to position his horse behind the barrier enabling the contestant to rope the animal without attempting to leave the box.

inhumane treatment of the animal being worked, such as, but not limited to rider hitting or kicking the animal

SHW527.6 Faults to be scored according to severity include:

jerking the reins

slapping

jerking the rope or any unnecessary action to enhance the performance of the horse

turning around in the box

turning head severely

squatting in the corner

stopping crooked

rearing up in stop

ducking off

looking off while working the rope

shying away while roper is remounting

SHW528. BREAKAWAY ROPING. This event shall be performed following the same general rules as youth tie-down roping, and is available only in the amateur and youth divisions. This is a timed event with a one-minute time limit and calves must be used.

SHW528.1 Horses must start from behind a barrier.

SHW528.2 A 10-second penalty will be added to the time for breaking the barrier.

SHW528.3 Two loops will be permitted. One or two ropes are to be tied to the saddle horn by a heavy string, in such a manner as to allow the rope to be released from the horn when the calf reaches the end of the rope. A visible cloth or flag must be attached to the end of the rope tied to the horn to make it easier for the flagger to see it break free.

SHW528.4 If the roper is carrying one rope and the roper desires to use a second loop, he/she may recoil provided the rope is still tied by a string to the saddle horn. If the rope is no longer attached to the saddle horn with the string after the roper has thrown the first loop, it cannot be rebuilt for a second throw. If the roper is carrying two loops he may use the second loop provided it is still attached to the saddle horn with a string. If the second loop falls loose, it cannot be rebuilt.

SHW528.5 The contestant may free his first rope from the horn after a miss, before getting his second loop ready if he wishes.

SHW528.6 The contestant shall receive no time should he break the rope from the horn by hand or touch the rope or string after the catch is made. If the rope dallies or will not break free when the calf reaches the end of it, the contestant will receive no time.

SHW528.7 Time will be called from drop of flag at barrier to the break of rope string from the saddle horn. A legal catch is a loop that passes over the head of the calf and then holds on any part of the calf to cause the string to break away from the saddle horn. Roping the calf without releasing the loop from the hand is not permitted.

SHW528.8 The contestant shall not attempt to rope the animal until the barrier flag has been dropped. Any attempt by a contestant to position his horse behind the barrier, enabling the contestant to rope the calf without leaving the barrier or box, shall be considered

a disqualification.

SHW528.9 Rope may not pass through bridle, tie-down, neck rope or any other device.

SHW528.10 A judge may, at his discretion, use the ring steward, other show officials or approved judges to assist as barrier judges and to help determine legal catches or any rule infractions.

SHW529. DALLY TEAM ROPING. The heading horse and the heeling horse are to be entered and scored individually, not as a team. If a contesting horse makes more than one run as a header, or as a heeler, it must be designated ahead of time as to which run is to be judged.

SHW529.1 All heading and heeling cattle shall be protected by horn wraps.

SHW529.2 Legal catches are required by both the header and heeler. See LEGAL CATCHES.

SHW529.3 The roper on the horse being judged may throw only two loops. If more than one loop is thrown, rider must recoil rope and build additional loop or loops. If the roper fails to catch, he will retire from the arena with no score.

SHW529.4 The rider who is heeling for the header may use two loops within the one-minute time limit from the time the steer is released from the chute.

SHW529.5 The rider who is heading for the heeler may use two loops.

SHW529.6 The header must head the steer and the heeler must heel the steer. Horses cannot switch positions.

SHW529.7 Riders are to stay mounted. When both ropes are dallyed and both horses are facing stretched steer, run is completed. Prohibit excessive stretching of the steers. Definition of excessive stretching is intentional and continuous stretching of the steer after the horses have faced. The rope must be wrapped around the saddle horn at least one complete turn before it is considered a dally. Riders age 50 and over and females are permitted to have their rope tied onto the horn of the saddle when heeling.

SHW529.8 Each contestant will select the other member of his team, who may or may not be competing in this class.

SHW529.9 The amateur being judged may be assisted by anyone, amateur or non-amateur.

SHW529.10 The youth being judged may be assisted by any youth, contestant or non-contestant, or any adult.

SHW530. SCORING. Scoring will be on the basis of 0-100, with 70 denoting an average performance. Each maneuver will be scored from a plus three to a minus three, in 1/2 point increments.

SHW531. The heading horse will be judged on four different maneuvers:

- Box and barrier
- Running and rating
- Setting and handling
- Facing

SHW532. Penalties. A heading horse will be penalized as follows:

SHW532.1 Two (2) points

- freeze up in the box (refusing to move)
- jumping the barrier
- setting up or scotching
- ducking off
- failure to face completely
- freeze up while facing

SHW532.2 Three (3) points

additional loop on either end

SHW532.3 Five (5) points

refusing to enter the box

rearing up in box

broken barrier

running into the steer

refusing to pull

blatant disobedience including kicking, biting, bucking, rearing and striking

SHW532.4 Disqualified (0) – Score

intentional and continuous stretching of the steer after the horses have faced

excessive schooling at any time in the arena

whipping or striking the horse with the rope

if both the header and heeler fail to complete both catches within one minute from the time the steer leaves the chute

loss of rope by either the header or the heeler

failure of the roper on the horse being judged to catch with no more than two loops. If more than one loop is thrown, rider must recoil rope and build an additional loop.

failure to maintain a dally through the completion of the run.

The rope must be wrapped around the saddle horn at least one complete turn before it is considered a dally

refusal to face

SHW532.5 Faults to be scored according to severity include:

jerking the reins

slapping

jerking the rope or any unnecessary action to enhance the performance of the horse

turning around in the box

turning head severely

squatting in the corner

incorrect position

failure to rate

failure to run to steer

horse being outrun by the steer

SHW533. The heeling horse will be judged on four different maneuvers:

Box

Run and rate

Position

Stopping

SHW534. Penalties. A heeling horse will be penalized as follows:**SHW534.1 Two (2) points**

header breaking the barrier

SHW534.2 Three (3) points

additional loop on either end

SHW534.3 Five (5) points

refusing to enter the box

rearing up in box

assuming position on the wrong side of the steer

running into the steer

failure to stop on hindquarters and hold position through the completion of the run

blatant disobedience including kicking, biting, bucking, rearing and striking

SHW534.4 Disqualified (0) – Score

intentional and continuous stretching of the steer after the horses have faced

excessive schooling at any time in the arena

whipping or striking the horse with the rope

if both the header and heeler fail to complete both catches within one-minute from the time the steer leaves the chute

loss of rope by either the header or the heeler

failure of the roper on the horse being judged to catch with no more than two loops. If more than one loop is thrown, rider must recoil rope and build an additional loop.

failure to maintain a dally through the completion of the run.

The rope must be wrapped around the saddle horn at least one complete turn before it is considered a dally

SHW534.5 Faults to be scored according to severity include:

jerking the reins

slapping

jerking the rope or any unnecessary action to enhance the performance of the horse

turning around in the box

turning head severely

squatting in the corner

incorrect position

failure to be in correct lead before horse moves into position on the steer

SHW540. TEAM PENNING. A team of three riders must sort three specifically identified head of cattle from a herd and then pen them at the other end of the arena. Time continues until all unpened cattle are completely on the cattle side of the starting line, within a specified time limit. The fastest time wins.

SHW540.1 The numbers and working order will be drawn by the judge and show management before the start of the contest.

SHW540.2 All cattle will be bunched on the cattle side of the starting line before the time begins.

SHW540.3 There shall be two flagmen, one at the entrance to the pen and one at the start/foul line. The judge must be located at the start/foul line, and may or may not actually flag the contest at his/her discretion.

SHW540.4 There shall be at least two timekeepers. The first timer shall be the official time and the second timer shall be the back-up time, in the event the first timer misses the time or his watch fails.

SHW540.5 The line flagman will raise the flag to signal when the arena is ready.

SHW540.6 Contestants will be given their cattle penning number when the line flagman drops his flag as the nose of the first horse crosses the starting line. Riders are committed once they cross the start line.

SHW540.7 Once committed to the cattle, the team is responsible for their animals. It is the team's responsibility, before working the cattle, to pull up and call for a judge's decision if, in their opinion, there is an injured or unusable animal in their numbered cattle. Once the cattle are worked, no excuses are accepted.

SHW540.8 If for any reason a team does not participate after the order of go has been drawn, their cattle number will be drawn and announced in the order the team would have run. The drawn number will not be used in that set of teams. This will avoid changing the order of go for the other contestants.

SHW540.9 Three divisions, all-age youth, all-age amateur and all-age open may be offered. Select amateur classes may also be offered as a separate class from all-age amateur.

SHW540.10 A snaffle bit, curb bit or hackamore may be used no matter the age of the horse and may be ridden two handed.

SHW540.11 Cattle numbers must be minimum of six inches (15cm) tall. Numbers must be applied to both sides of the animal, high up on its side, with the top near the midline of the animal's back between the shoulder and the hip.

SHW540.12 The optimum number of cattle per herd is 30; however, a maximum of 45 are allowed and a minimum of 21 per herd is required even if there are less than seven teams. All cattle within a herd must be numbered in groups of three.

SHW540.13 There must be three head of assigned (identical numbers) cattle per team in the herd as each new team begins a run.

SHW540.14 There must always be the same number of cattle in each of the herds used in a go-round.

SHW542. Measurement. The starting and foul line must be designated by markers located on the arena fence, and easily viewed by the line judge and the exhibitors. The foul line shall be between 30 percent and 35 percent of the arena length from the cattle end of the arena, and the foul line shall be determined and advertised as such by the show manager. The foul line may be extended by five percent for each 10' beyond 110' in width, to accommodate bigger, wider arenas. The entry gate to the pen shall be situated 25 percent of the distance from the arena back wall, but shall not be less than 55 feet from the arena back wall.

SHW543. Time. Show management may use 60, 75, or 90 second time limits for each division, but must advertise accordingly.

SHW543.1 A warning must be given to the team working the cattle at 30 seconds, prior to a final time being called.

SHW543.2 To call for time, one rider must stand in the gate and raise a hand for the flag. Flag will drop when the nose of the first horse enters the gate and the rider calls for time.

SHW543.3 Time continues until all unpenned cattle are completely on the cattle side of the starting line.

SHW544. Penalties. All penalties incurred will be added to a qualified run even if the penalty time exceeds time limit.

SHW544.1 Rerun

SHW544.1.2 In the event the 30 second warning is not given, a rerun may be given at the request of the team. If the team requests a rerun, the cattle will be settled and a rerun will immediately be given using the same numbered or color-banded cattle, with a 60 second penalty.

SHW544.1.3 If an animal leaves the arena, either over or through the fence, the team can either be disqualified for unnecessary roughness, or can be given a rerun, depending on the judge's decision. If a rerun is given, it must be given at the end of that set of cattle.

SHW544.1.4 If no fresh cattle are available for reruns, the cattle to be used will be determined by the show management

and judge. If more than one rerun is given in any go-round, they will be taken in order of occurrence. If cattle are to be re-used and additional fresh cattle are needed, the used cattle must be mixed with fresh cattle and renumbered. Every attempt must be made to insure each team works the same number of used and fresh cattle.

SHW544.1.5 If a team is given a number that has already been used within a given herd, a rerun must be given immediately, using the correct number within that same herd. Should the error be discovered after the herd has been removed from the arena, then the rerun will be given at the end of the total go-round using the same herd.

SHW544.1.6 In the event more or less than three assigned (identical numbers) cattle are discovered within a herd, the team(s) with more or less than three assigned cattle must have a rerun at the end of that set of cattle. Times for all other teams within such a mis-numbered herd will remain the same.

SHW544.1.7 Cattle cannot be reused within a go-round of a division except as specified in above rule for reruns.

SHW544.2 No Time

SHW544.2.1 will be given if an animal is knocked or cut into the pen after time is called

SHW544.2.2 if an animal escapes from the pen, when team is calling for time

SHW544.2.3 if animal escapes from the pen, when team is calling for time prior to the time when all unpenned cattle are on the cattle side of the starting line. Escaped animal is one with any part of the animal coming out of the opening of the pen

SHW544.2.4 if team exhibits any unnecessary roughness.

SHW544.2.5 excessive use of a whip, rope, crop, bat or reins anywhere on the horse

SHW544.2.6 Any part of the trash animal that crosses the line will invoke a no time

SHW544.2.7 any wrong numbered cattle across the line "no trash rule"

SHW544.3. Disqualification

SHW544.3.1 any delay by the contestants to start

SHW544.3.2 contact with cattle by hands, hats, ropes, bats, romal or any other equipment. No hazing with whips, hats or ropes allowed. Romals or reins may be swung or popped on chaps

SHW544.3.3 unnecessary roughness to cattle or horses or unsportsmanlike conduct

SHW544.3.4 fall of horse and/or rider shall not eliminate the entry; however any attempt by a dismounted rider to work cattle before remounting will result in a disqualification

SHW544.3.5 disqualification of a team member will result in disqualification of the entire team.

SHW545. Placing/Ties. A team may call for time with only one or two assigned cattle being penned. However, teams penning three head of cattle place higher than two, and two higher than one, regardless of time. In multiple go-round contests, teams that pen in each go-round will beat teams that fail to pen in a go-round, regardless of the number of cattle penned or time. In a multiple go-round contest, teams must pen to advance. In multiple go-rounds, times and cattle count are accumulated to determine placings.

TEAM PENNING

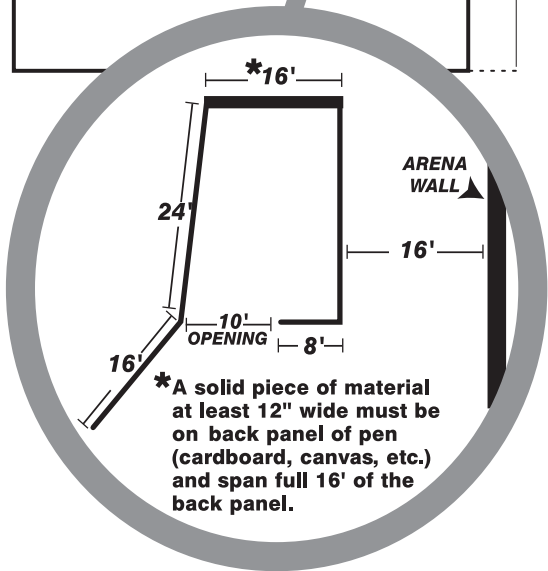
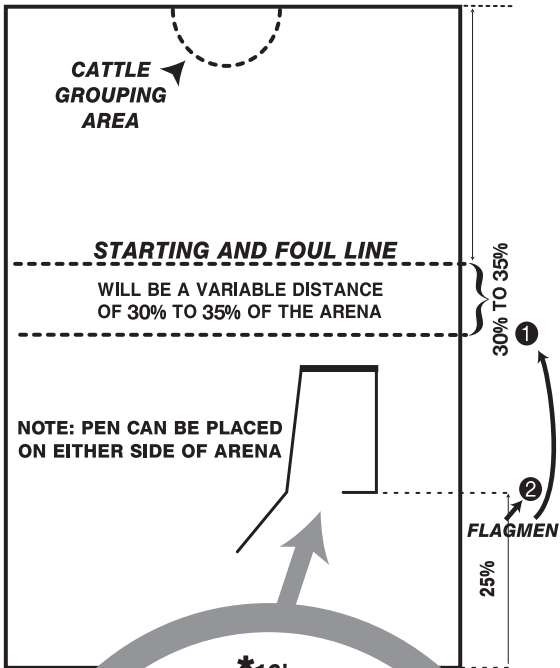

SHW545.1 In the event of a tie affecting the placings, each team will be allowed to pen one numbered animal. Fastest time breaks the tie.

SHW545.2 Points will be awarded based on the number of teams entered. For every five teams there will be a point awarded to each of three winning team members.

SHW547. RANCH SORTING. Ranch sorting is derived from the ranching practice of sorting cows from calves or steers from heifers where finesse, agility and cattle working skills excel. It is a fun competitive timed event that matches a two rider team against 11 head of cattle to be sorted in numerical order from one sorting pen to another. The most cattle sorted in the fastest time wins. This family-oriented class showcases the great American ranching heritage in arenas all across the country. Points will be awarded based on the number of teams entered. For every five teams there will be a point awarded to each of the two winning team members. The basic concept of ranch sorting is that there are ten numbered cattle, 0-9, and one unnumbered for a total 11 head at the beginning of a run behind a foul line in an arena with two people mounted on the other side of the foul line.

SHW547.1 Ranch sorting will take place between two pens of approximately equal size with show management's option of working cattle back and forth or only one way. Two ranch sorting arenas may be placed side by side with odd numbered teams in one arena and even numbered teams in the other arena. If cattle are to be worked back and forth, they need to be moved to the opposite pen and back before each new herd entering the arena is worked. Recommended sorting area to be 50' - 60' in diameter with no 90 degree corners, i.e. 60' round pen or octagonal "stop sign" design.

SHW547.2 The start foul line will be recommended as a 12' - 16' opening between the two pens.

SHW547.3 There will be either a 90, 75, or 60 second clock for each class, at the option of show management. The official clock is the electronic display clock and is required at all sorting shows. The official time of each run is determined by the amount of time used until all 10 cattle are sorted or the time limit has expired. Time will continue until all cattle are sorted in the correct order or the time limit is reached, either of which becomes the official time for that team.

SHW547.4 A lap timer is to be used in all sorting classes to break ties where the cattle count is equal in runs of less than 10 cattle sorted. The stop watch used for lap time purposes will also be the back-up timer in the event of a malfunction of the electronic display clock. Lap times are cumulative in multiple go-round events as well as the number of cattle sorted, but do not replace the official time of each run. Lap times only come into play when the cattle counts and the official times are identical.

SHW547.5 There will be a minimum of one judge for sorting, to be positioned evenly with the foul line.

SHW547.6 All cattle will be bunched on the cattle side of the gate within the designated area before the time begins. At the conclusion of each run, the judge will designate the need to bunch cattle.

SHW547.7 The judge will raise the flag to signal when the arena is ready. The flag will drop when the nose of the first horse crosses the start/foul line and the announcer will provide the number to be sorted first. The riders will be given their number instantly. Any delay in crossing the foul line may result in a "no-time" for the team. With particular interest, that no one or two cattle are isolated.

SHW547.8 All cattle must have approved back numbers; neck numbers are not acceptable. The cattle are sorted in order. If any part of a numbered cow crosses the start/foul line prior to its correct order, then the team receives a no-time. If any part of a sorted cow re-crosses the start/foul line, the team will be disqualified. If any part of any unnumbered cow crosses the foul line before the tenth cow is cleanly sorted, it will result in a no-time.

SHW547.9 The order of sorting is determined by the picking of a random number by the announcer/timer and then that cow must be sorted first. For instance, if 5 is drawn as the first number, 5 is sorted first, then cow 6 must be sorted, 7, 8, 9, 0, 1 and so on. A cow is considered sorted when the entire cow is completely across the start/foul line.

SHW547.10 If there is a malfunction of the sorting pen or a numbered cow jumps any fence and either leaves the arena or ends up in the opposite pen, but did not pass through the gate, it will result in a re-ride for that team at the end of the herd (assuming it was not caused by roughing of the cattle). In the instance of a re-ride, exhibitors will receive a full (90, 75 or 60 second) clock, but the exhibitor's time cannot be improved. However, the number of cattle sorted during the allotted time can be improved. (Example: If a team had five head in 55 seconds (with a 60 second clock) when the cow jumped the fence, they would get a re-ride with the full 60 second clock. In the re-ride, the same team sorted ten head in 50 seconds. Their official time would be ten head in 55 seconds).

SHW547.11 Should a herd be numbered incorrectly or have too many non-numbered cattle, the team(s) will receive a re-ride at the end of that set of cattle. If a team is given a number that has already been used within a given herd, a rerun must be given immediately, using the correct number within that same herd.

SHW547.12 At the judge's discretion, if a re-ride is given because of un-numbered, injured or unfit cattle, the re-ride will occur immediately using the same numbered cattle once unjured, unfit or un-numbered cattle are replaced.

SHW547.13 Any unnecessary roughness to cattle or horses or unsportsmanlike conduct may result in disqualification.

SHW547.14 Any excessive use of a whip, rope, crop, bat or reins anywhere on the horse will be cause for disqualification.

SHW547.15 Three divisions, all-age youth, all-age amateur and all-age open may be offered. Select amateur classes may also be offered as a separate class from all-age amateur. Points will be awarded based on the number of teams entered in the class. For every five teams, there will be a point awarded to each of the two winning team members.

SHW547.16 In multiple go round events, teams must sort cleanly with a time to advance.

SHW547.17 A snaffle bit, curb bit or hackamore may be used no matter the age of the horse and may be ridden two handed.

SHW550. VERSATILITY RANCH HORSE DIVISION. The versatility ranch horse division demonstrates the performance, versatility and conformation of the American Quarter Horse as a working ranch horse. The intent is to reward an exhibitor and/or horse based on their level of expertise.

SHW551. APPROVAL. Ranch horse shows will be held as stand-alone events or in conjunction with other like events. There will be an approval fee of \$150 per event. No more than four shows a month within

SINGLE SORTING ARENA CONFIGURATION

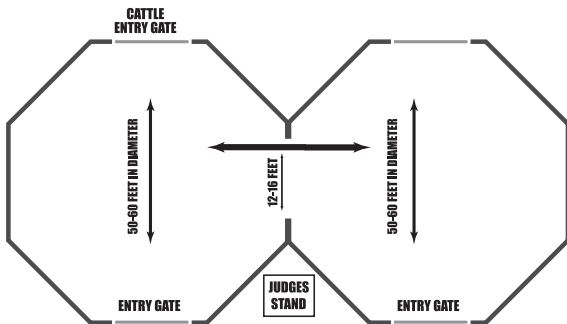

RIDERS ENTER AT GATE IN ARENA WITH NO CATTLE. CATTLE SORTED TO OPPOSITE ARENA WILL BE SORTED BACK BY NEXT TEAM.

DOUBLE SORTING ARENA CONFIGURATION

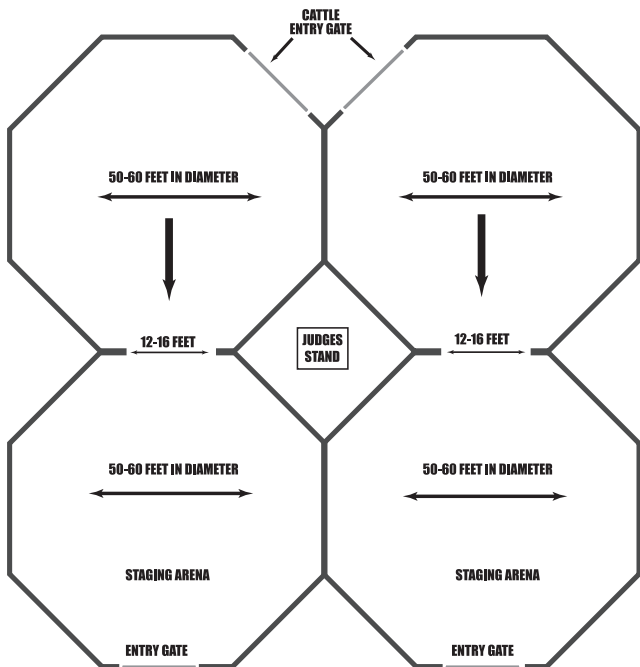

RIDERS ENTER AT GATE IN ARENA WITH NO CATTLE. TEAMS ARE DIVIDED AND ARENAS DESIGNATED AS EVEN AND ODD. AS ODD TEAM SORTS, EVEN TEAM STAGES TO EMPTY ARENA UNTIL ODD TEAM COMPLETES SORT AND VICE VERSA. CATTLE SORTED TO OPPOSITE ARENA ARE RETURNED BY TEAM THAT SORTED. NEXT TEAM SHOULD ONLY ENTER WHEN CATTLE HAVE BEEN RETURNED AND SETTLED BY PREVIOUS TEAM.

a region (according to the regions of AQHYA) will be approved. Each show must include all four categories. There will be four categories with a total of seven classes that could be offered.

Category I	VRH	Ranch Riding, Ranch Trail
Category II	VRH	Ranch Reining
Category III	VRH	Ranch Cutting, Ranch Cow Work, Limited Ranch Cow Work
Category IV	VRH	Ranch Conformation

SHW552.DIVISIONS. Four divisions will be offered: open, cowboy, amateur, and youth (18 and under).

SHW552.1 Open exhibitors would be allowed to show three junior horses and three senior horses in each class if held as a Junior/Senior class. If held as an all-age class, an open exhibitor could show up to four horses in each class.

SHW552.2 Cowboy, amateur and youth exhibitors would be eligible to show up to three horses in each class. AQHA criteria will be used to determine eligibility for open, amateur, and youth exhibitors.

SHW552.3 The cowboy division is for working ranch cowboys. The rider of the horse must either be an owner, family member or full time employee of the ranch that owns the horse. Employees must have been employed for a minimum of 90 days prior to competing in the ranch horse competition. The rider must have less than \$5,000 per association lifetime earnings in any of the following: NRHA, NCHA, NRCHA, ACHA, RHAA, ASHA or SHOT or less than 25 AQHA or American Paint Horse Association Open points in reining, cutting, ranch cow horse or versatility ranch horse within the previous 10 years. No exhibitor can have earned more than \$5,000 in any individual association.

SHW553. SHOW MANAGEMENT: Show management will have the option of offering only one cattle class. This can either be ranch cutting or ranch cow work. However both classes may be offered.

SHW553.1 Ranch riding and ranch trail may be combined and held at the same time or held independently. If combined, each class will be scored individually and placed individually.

SHW553.2 Ranch reining and ranch cow work may be combined and held at the same time or each class held separately. If combined, each class will be scored individually and placed individually.

SHW553.3 Entries close no later than one week prior to the event. Multiple arenas may be used and encouraged in order to expedite the show in order to finish in a timely manner.

SHW553.4 Clinics or educational opportunities may be offered and encouraged to be held prior to the competition.

SHW554. POINTS. Points will be awarded in each individual class according to the placing received and based on the total number of horses competing in that particular class. Points earned in the ranch horse show competitions only count toward any award or qualification for the ranch division and do not count toward any other award or qualification for any other approved AQHA class or AQHA show award.

SHW555. ALL-AROUND VERSATILITY RANCH HORSE. The title of All-Around Versatility Ranch Horse will be named in the open, cowboy, amateur and youth divisions for each show if earned. Each division is calculated independently for the number of horses competing in that division. Additional points based on the number of

horses/exhibitors in that division competing for the All-Around will be awarded. To be eligible for points for the all-around versatility ranch horse title, one horse one rider must enter and show in a minimum of three categories. To qualify for the all-around versatility ranch horse, one cattle class must be included and the horse must also show in the conformation. One additional class from the two remaining categories must be entered and shown. Additional classes may be entered and shown and will also count toward the All-Around. Horses going for the all-around ranch horse will be placed against each other in addition to their class placing. The first place horse in each class that is eligible for the all-around will receive 9 credits no matter the number of other horses entered or eligible. Second all-around will receive 8 credits and so on. For example, a horse competing for the all-around may place 16th in the class. If they are the first all-around placing entry they will receive 9 credits. The next all-around horse placed 22 in the same class. They will receive 8 credits and so on. Another example: In a class of six at the same show, the all-around eligible horse is second in the class. They would receive 9 credits. The next all-around eligible horse places fourth in the class, they would receive eight credits and so forth. After totaling credits, the horse receiving the highest number of credits in that division will be placed first for the All-Around versatility ranch horse in that division and receive additional points based on the number of horses competing for the all-around title. Points earned in the limited cow work classes do count for the title of All-Around Versatility Ranch Horse for amateur and youth.

SHW555.1 If there are ties in the final placing for the all-around versatility ranch horse they will be broken by the highest placing horse in the ranch cow work class. If additional tie breakers are needed, refer to rule SHW558.3

SHW555.2 Year-End High-Point will be awarded to the All-Around in each division only based on number of all-around total points and not in the individual classes.

SHW556. CLASS PARTICIPATION.

SHW556.1 No horses less than 3 years of age may be exhibited.

SHW556.2 No hoof polish.

SHW556.3 No braided or banded manes/tails or tail extensions.

SHW556.4 Trimming inside ears is discouraged.

SHW556.5 Trimming bridle path is allowed, also trimming of fetlocks or excessive (long) facial hair.

SHW556.6 Equipment with silver should not count over a good working outfit. Silver on bridles and saddles is discouraged.

SHW556.7 Holding the saddle horn with either hand will not be penalized in any class.

SHW556.8 Posting at the extended trot is acceptable.

SHW556.9 For shows conducted in international countries, the exhibitor has the option of wearing traditional attire of the country.

SHW557. SCORING SYSTEM. The scoring system is designed to be positive, straightforward, and always encourage growth and improvement in both horse and rider. The scoring system is designed to give credit for the work done.

SHW557.1 Except for the conformation class, each horse/rider team is scored between 1-100 points and automatically begins

the run with a score of 70 points. The horse/rider team is scored on the quality of each maneuver (e.g., -1 1/2 extremely poor, -1 very poor, -1/2 poor, 0 correct, +1/2 Good, +1 very good, +1 1/2 excellent). Pluses and minuses are a reflection of the smoothness, finesse, attitude, quickness and authority of the horse/rider team when performing the various maneuvers. Penalties may be accrued for incorrect maneuver execution.

SHW557.2 In each class, the entire class will be scored and placed. All exhibitors in each class will be ranked according to scores, placed from the highest to the lowest scores. In the case of a horse/rider team being off-pattern, leaving working area before pattern is complete, repeated blatant disobedience, fall of horse/rider, the horse/rider team cannot place above other horse/rider teams who have completed the pattern correctly.

SHW557.3 No horse/rider team shall be disqualified except for illegal equipment, obvious lameness, inhumane treatment, and or rider misconduct or disrespect. Disqualified horses will count as entries in the class but will not receive points.

SHW557.4 In the case of a fall by a horse or rider, the run shall end when the rider or horse fall to the ground. A horse is considered to have fallen when all four feet are extended in the same direction. A rider is considered to have fallen when the rider is no longer astride. A horse/rider team will be given credit for their work prior to that point but cannot place above other horse/rider teams who have completed the pattern correctly.

SHW557.5 In the case of equipment that delays competition or becomes unsafe, the run is stopped and the horse/rider team will be given credit for what they have accomplished prior to that point but cannot place above other horse/rider teams who have completed the pattern correctly.

SHW557.6 In each class, specific maneuvers will be designated by the judge to be tiebreakers. The tie-breaker maneuvers will be made prior to the start of the class and so noted on score sheets. These maneuvers will be ranked as first tie-breaker, second, third and so forth.

SHW558. JUDGING PROCEDURES. Judges must be chosen from the AQHA Versatility Ranch Horse approved judges' list. Judges shall use approved score sheets to score all classes. Specific maneuvers will be selected by the judge prior to the class as tie-breaking maneuvers. These maneuvers will be ranked as first tie-breaker, second, third etc.

SHW558.1 During the class, a scribe shall assist each judge by recording the score after each of the maneuvers on the appropriate class score sheet. Judges shall sign their score sheets.

SHW558.2 Class score sheets shall be posted as soon as possible after each class to allow riders to evaluate their performance.

SHW558.3 Exhibitors competing for the All-Around Versatility Ranch Horse, shall have their class placing credits entered into the all-around tabulation. Credits from each class shall be added together for the overall placing for the event. Ties for the all-around versatile ranch horse are broken first using the highest placing in the ranch cow work class. If this does not break the tie, other classes will be used in the following order: ranch cutting, ranch reining, ranch trail and ranch riding.

SHW558.4 At the option of show management, when using two judges to determine one set of winners, the classes will first be placed under each judge and class placing points awarded and posted. One judge shall be designated as the “tie –breaker judge” before judging begins. The composite results (combined results used to determine an overall winner) shall be determined as follows: All class placing points will be added for each judge to determine an all-around winner. If there is a tie, the tie-breaker judge’s class placing will determine the winner. Ties for the all-around winner are broken first using the highest placing in the ranch cow work class.

SHW560. VRH RANCH RIDING. The VRH ranch riding class measures the ability of the horse to be a pleasure to ride while being used as a means of conveyance from one ranch task to another. The horse should be well-broke, relaxed, quiet, soft and cadenced at all gaits. The horse should be ridden on a relatively loose rein with light contact and without requiring undue restraint. The horse should be responsive to the rider and make timely transitions in a smooth and correct manner. The horse should be soft in the bridle and yield to contact. The ideal ranch riding horse should have a natural and level head carriage at each gate.

SHW560.1 Horses shall be shown individually and the class may be conducted inside or outside of an arena. The pattern may be started either to the right or left direction. Show management has the option to set markers to designate gait changes. If the class is held inside an arena, the course shall be set up to make approximately one pass of the arena in each direction. The suggested ranch riding pattern may be used or another pattern may be used as long as all elements of the class are fulfilled as follows:

- Horses will be shown individually at three gaits; walk, trot and lope in each direction of the arena.
- Horses will also be asked to reverse away from the rail, and be asked to stop and back.
- The judge must ask for an extended trot and extended lope at least one direction of the ring.

SHW560.2 CREDITS AND PENALTIES. Part of the evaluation of this class is on smoothness of transitions. A horse may be collected from the extended trot as the horse moves into the lope. The transition from the extended lope down to the trot is a transition to the seated trot not the extended trot. Therefore, an extra cue to achieve this gait is expected. Horses that complete this total transition within three strides calmly and obediently should be rewarded. Horses that attempt to stop or do stop prior to trotting will be penalized. Judges expect to see horses that have been trained to respond to cues. To see these cues applied discretely and the horse responding correctly could be a credit-earning situation. Penalties will be assessed as follows:

- **1 Point:** Over-bridled, out of frame, too slow, gaping mouth, break of gait at walk or jog for two (2) strides or less.
- **3 Point:** Wrong lead or out of lead, draped reins, break of gait at lope, break of gait at walk or jog for more than two (2) strides.
- **5 Point:** Spurring in front of cinch, blatant disobedience, use of either hand to instill fear/praise, use of two hands per maneuver, 1st or 2nd cumulative refusal, more than one finger

SUGGESTED VERSATILITY RANCH RIDING PATTERN I

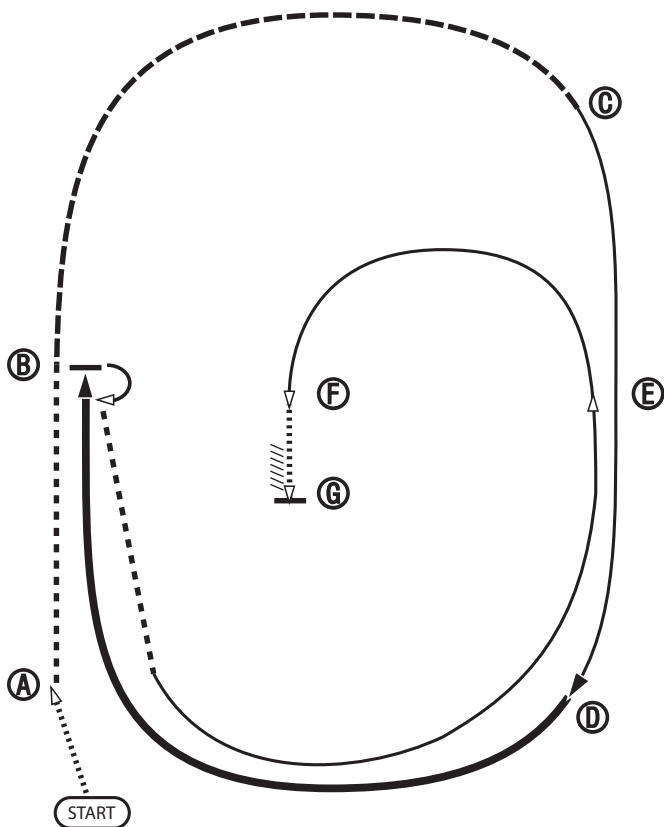

1. Walk from start cone to cone A.
2. Jog from A to B.
3. Extend the jog from B to C.
4. Lope on the right lead from C to D.
5. Extend the lope from D to B.
6. Stop at B, turn and jog to A.
7. Lope on the left lead from A to E.
8. Turn toward the middle of the arena and continue to lope to F.
9. Walk from F to G.
10. Stop and back approximately one horse length.

(Realizing trail course is set in arena, ranch riding pattern can be adjusted to fit arena conditions)

between split reins or any fingers between reins (except two rein) per maneuver. Cannot place above others who complete pattern correctly.

Off-Pattern: Breaking pattern, leaving working area before patten is complete, repeated disobedience, fall of horse/rider, (run ends and credit will be given for work done). Cannot place above others who complete pattern correctly.

Disqualification: Lameness, abuse, illegal equipment, disrespect or misconduct, improper western attire.

SHW561. VRH RANCH TRAIL. The ranch trail class should test the horse's ability to cope with situations encountered in everyday riding. The horse is ridden through a pattern of obstacles which should nearly approximate those found during the course of everyday work. The horse/rider team is judged on the correctness, efficiency and pattern accuracy with which the obstacles are negotiated and the attitude and mannerisms exhibited by the horse. Judging emphasis is on identifying the well-broke, responsive and well-mannered horse which can correctly navigate and negotiate the course.

SHW561.1 The ranch trail course will include no less than six and no more than nine obstacles. It is mandatory that the horse be asked to walk, trot and lope during the course. Walk can be part of obstacle score or be scored with the approaching obstacle. Trot must be at least 35 feet and score with approaching obstacle. Lope must be lead-specific, at least 50 feet and score with approaching obstacle. Care must be exercised to avoid setting up any obstacles that may be hazardous to the horse or rider.

SHW561.2 When setting courses, management will be mindful that the idea is not to trap a horse/rider team or eliminate it by making an obstacle too difficult. All courses and obstacles are to be constructed with safety in mind so as to reduce the risk for accidents. Show committee shall have the option of setting up the trail course to best fit the arena conditions. An outdoor course is recommended if appropriate terrain is available. Each single-performance event can be time consuming, especially with large classes, so it is imperative that time restrictions are place on this class. The show committee, either through a pilot run or estimation, shall select a course that has a continuous and positive flow that can be negotiated in four minutes or less.

SHW561.3 Judges must walk the course and have the right and duty to alter the course if it is not in keeping with the intent of the class. Judges may remove or change any obstacles they deem unsafe, non-negotiable or unnecessarily difficult. Any time a tail obstacle becomes unsafe during a class, it shall be repaired or remove from the course. If the course cannot be repaired and some horses have completed the course, the score for that obstacle shall be deducted from all previous work for that class.

SHW561.4 The course must be designed using the mandatory obstacles and maneuvers plus optional obstacles. Combining two or more of the obstacles is acceptable.

SHW561.5 PROHIBITED OBSTACLES: Tarps, water obstacles with slick bottoms, PVC pipe used as a jump or walk over, tires, rocking or moving bridges, logs or poles elevated in a manner that permits such to roll in a dangerous manner.

SHW561.6 MANDATORY OBSTACLES AND/OR MANUEVERS.

- Ride over obstacles on the ground (usually logs or poles). Walk, trot or lope may be used but only one gait is required.
- Walk-overs: Walk over no more than five logs or poles no more than 10 inches high and spacing between 26 – 30 inches. The formation may be straight, curved, zigzagged or raised.
- Trot-overs: Trot over no more than five logs or poles no more than 10 inches high. The space between logs or poles should be 30-42 inches. The formation can also be straight, curved, zigzagged or raised.
- Lope-overs: Lope over no more than five logs or poles no more than 10 inches high. The space between logs or poles should be 6 to 7 feet. The formation can also be straight, curved, zigzagged or raised.
- Opening, passing through and closing gate: Use gate that will not endanger horse or rider and requires minimum side-passing.
- Ride over wooden bridge: Bridge should be sturdy, safe and negotiated at a walk only. Heavy plywood lying flat on the ground is an acceptable simulation of a bridge. Suggested minimum width shall be 36 inches wide and at least 6 feet long.
- Backing obstacles: Backing obstacles are to be spaced at a minimum of 28 inches. If elevated, 30 inch spacing is required. Back through and around at least three markers. Back through L, V, U or straight or similarly shaped course which may be elevated no more than 24 inches.
- Side-pass obstacle: Any object which is safe and of any length may be used to demonstrate responsiveness of the horse to leg signals. Raised side pass obstacles should not exceed 12 inches.
- Rope drag: For open, cowboy and amateur classes ONLY. A rope drag is not to be used in youth classes. Drag may be a complete figure eight and may begin in either direction.

SHW561.7 OPTIONAL OBSTACLES. Optional obstacles may be used provided the obstacles can be found in everyday ranch work. Optional obstacles from which selections can be made include, but are not limited to:

- A jump obstacle whose center height is not less than 14 inches high or more than 25 inches high. Holding the saddle horn is permissible for this obstacle.
- Only live or stuffed animals which would normally be encountered in an outdoor setting may be used but not to be used in an attempt to spook a horse.
- Carry object from one part of the arena to another.
- remove and replace materials from a mailbox.
- Trot through cones spaced a minimum of 6 feet apart.
- Cross natural ditches or ride up embankments.
- Swing rope or throw rope at a dummy steer head.
- Step in and out of obstacle.
- Put on slicker or coat.
- Stand to mount with mounting block.
- Walk through water obstacle.
- Open gate on foot.

- Pick up feet.
- Walk through brush.
- Ground tie.
- Lead at the trot.

SHW561.8 The competition trail course is not to be made available to exhibitors or posted prior to the day of competition. It must be posted at least one hour prior to competition. Printed handouts for exhibitors are helpful and encouraged. The exhibitor may walk the course on foot or be observed from the outside of the course on horseback but no horse/rider team is allowed on the actual course after it has been set until the horse/rider run begins.

SHW561.9 CREDITS AND PENALTIES. All runs begin upon entering the pen and any infractions are subject to penalty at that time (such as two hands on the reins, using either hand to instill fear or praise, etc.). The rider has the option of eliminating any obstacle and taking a score of "0" for the missed obstacle, however this will result in being "off pattern" and the horse/rider team may not place above others who have completed the pattern correctly. A judge may ask a horse to pass on an obstacle after three refusals or at any time for safety concerns.

SHW561.10 Credit is given to horse/rider teams who negotiate the obstacles correctly and efficiently. Horses should receive credit for showing attentiveness to obstacles and ability to negotiate through the course when the obstacles warrant it while willingly responding to rider's cues on more difficult obstacles. Quality of movement and cadence should be considered part of the maneuver score for the obstacle. Penalties are assessed as follows:

- 1 Point Penalties: Each hit, bite or stepping on a log, cone plant or any component of the obstacle, incorrect or break of gait at walk or jog for two (2) strides or less; both front or hind feet in a single-stride slot or space at a walk or jog; skipping over or failing to step into required space; split pole in lope-over; incorrect number of strides, if specified; one step on dismount or ground tie except shifting to balance.
- 3 Point Penalties: Wrong lead or out of lead; draped reins; break of gait at lope; break of gait at walk or jog for more than two (2) strides; two to three steps on dismount on ground tie.
- 5 Point Penalties: Spurring in front of cinch; blatant disobedience; use of either hand to instill fear/praise; use of two hands per maneuver; more than one finger between split reins or any fingers between romal reins per maneuver (except two rein); knocking over, stepping out of or falling off an obstacle; dropping an object required to be carried; 1st or 2nd cumulative refusal; letting go of gate.
- Off-Pattern: Breaking pattern; leaving working area before pattern is complete; 3rd refusal; repeated blatant disobedience; fall of horse/rider (run ends and credit will be given for work done). Exhibitors cannot place above others who complete pattern correctly.
- Disqualification: Lameness, abuse, illegal equipment, disrespect or misconduct, improper western attire.

SHW562. VRH RANCH REINING. The ranch reining class measures the ability of the stock horse to perform basic handling

maneuvers. Patterns may be chosen from any of the ranch reining patterns or other approved patterns by the show management and judge.

SHW562.1 CREDITS AND PENALTIES. All runs begin upon entering the pen and any infractions are subject to penalty at that time such as two hands on the reins, using either hand to instill fear or praise, etc.

SHW 562.2 To rein a horse is not only to guide him but also to control his every movement. The best reined horse should be willingly guided or controlled with little or no apparent resistance and dictated to completely. Any movement on his own must be considered a lack of control. All deviations from the exact written pattern must be considered a lack of or temporary loss of control and therefore a fault that must be marked down according to severity of deviation. The horse/rider team's overall performance should be credited for smoothness, finesse, attitude, quickness and authority of performing various maneuvers while using controlled speed which raises the degree of difficulty and makes the horse/rider team more exciting a pleasing to watch.

SHW562.3 PENALTIES:

- One-half (1/2) Penalties: Starting a circle or exiting a roll-back at a fog for up to two (2) strides; delayed change of lead by one stride where the lead change is required by the pattern description; failure to remain a minimum of twenty feet from the wall or fence when approaching a stop and/or roll-back; over-spin or under-spin up to 1/8 turn.
- 1 Point Penalties: Out of lead in the circles, figure eights or around the end of the arena (this penalty is cumulative and will be deducted for each quarter of a circle the horse is out of lead); Over or under spinning 1/8 to 1/4 turn. Slipping rein.
- 2 Point Penalties: Break of gait; freeze up in spins or roll-backs; failure to stop or walk before executing a lope departure on trot-in patterns; failure to be in a lope prior to the first marker on run-in patterns; failure to completely pass the specified marker before initiating a stop position.
- 5 Point Penalties: Spurring in front of cinch; blatant disobedience; use of either hand to instill fear/praise; use of two hands per maneuver; more than one finger between split reins or any fingers between romal reins per maneuver (except two rein).
- Off-Pattern: breaking pattern; inclusion of maneuver (e.g. over or under-spinning, backing more than two (2) strides, etc.); leaving arena before pattern is complete; repeated blatant disobedience; fall of horse/rider (run ends and credit will be given for work done). Exhibitors cannot place above others who complete the pattern correctly.
- Disqualification: Lameness; abuse; illegal equipment; disrespect or misconduct; improper western attire.

SHW563. VRH RANCH COW WORK. The ideal stock horse must also be a cow horse and this class demonstrates and measures the horse's ability to do cow work. Holding the saddle horn is permitted. There is a time limit per horse/rider team to perform the work depending on the division and the time begins when the cow is turned into the arena. If the

VRH Ranch Reining Pattern I

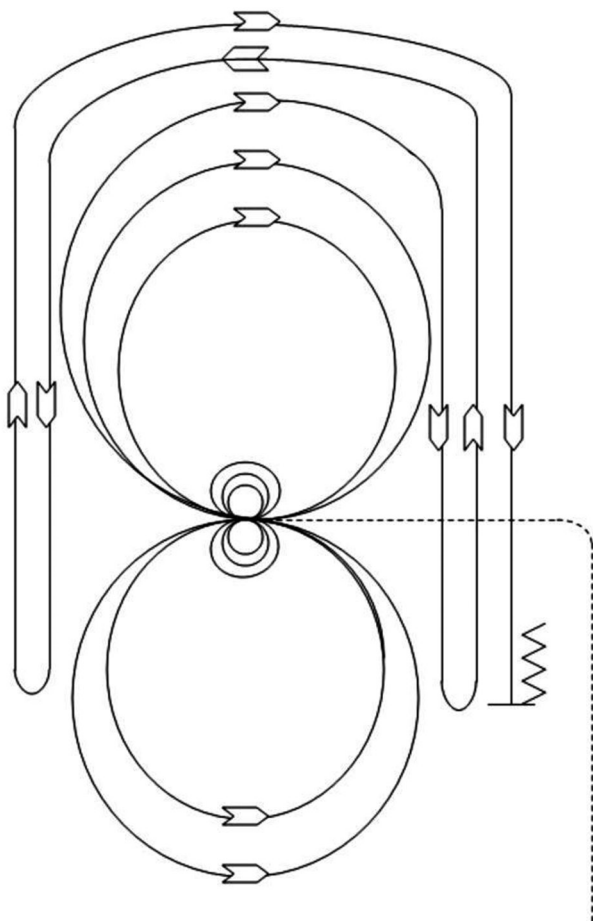

Mandatory Markers:

The judge shall indicate with markers on arena fence the center of the pattern.

Ride pattern as follows:

1. Trot to center of arena and stop.
2. Complete three spins in each direction
3. Begin on right lead and lope two large fast circles to the right, change leads.
4. Lope two large fast circles to the left, change leads.
5. Begin a large circle to the right but do not close this circle. Run down the right side of the arena past the center marker and do a left roll back at least 20 feet from the wall or fence, no hesitation.
6. Continue back around the previous circle but do not close this circle. Run down the left side of the arena past the center marker and do a right roll back at least 20 feet from the wall or fence, no hesitation.
7. Continue back around previous circle but do not close this circle. Run down the right side of the arena past the center marker and do a sliding stop at least 20 feet from the wall or fence. Back up at least 10 feet. Hesitate to show completion of pattern.

VRH Ranch Reining Pattern 2

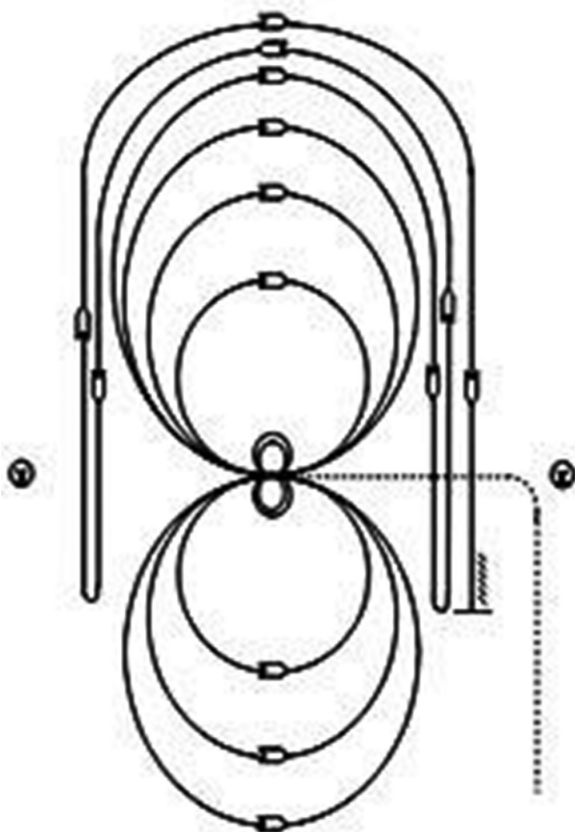

Mandatory Marker along Fence or Wall

The judge shall indicate with markers on arena fence or wall the center of pattern.

Ride pattern as follows:

1. Start by trotting into center of arena and either stop or walk before departure.
2. Make a large fast circle to right on the right lead.
3. Draw the second circle down to a small circle until you reach the center marker; stop.
4. Do four right spins at the center marker; hesitate
5. Begin on left lead and make a large fast circle
6. Then a small circle, again drawing it down to the center of the arena, stop.
7. Do four left spins, hesitate
8. Take a right lead & make a large fast circle to the right, change leads and make a large fast circle to the left, change leads
9. Begin a large fast circle to the right but do not close this circle. Run down the right side of the arena past the marker and do a left roll back at least 20 feet from the wall or fence
10. Continue back the arena, run down the left side of the arena past the center and do a right roll back at least 20 feet from the wall or fence
11. Run down the right side of the arena past the center marker and do a sliding stop at least 20 feet from the wall or fence. Back up at least 10 feet. Hesitate to show completion of pattern.

VRH Ranch Reining Pattern 3

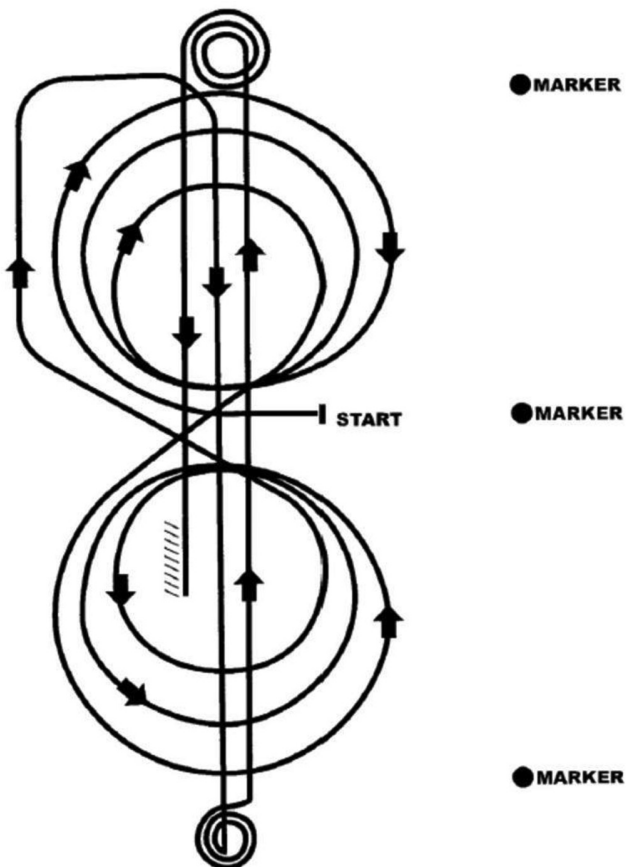

Mandatory Marker along Fence or Wall

The judge shall indicate with markers on arena fence or wall the center of pattern.

Ride pattern as follows:

1. Start by trotting into center of arena and stop. Start pattern facing toward judge.
2. Begin on right lead and complete three circles to the right, two large fast followed by one small slow circle, change to left lead
3. Complete three circles to the left, two large fast circles followed by one small slow circle. Change to right lead.
4. Continue loping around end of arena without breaking gait
5. Run up center of arena to far end past the end marker and come to a sliding stop.
6. Complete 3 1/2 spins to the right
7. Run up center of arena past the end marker, come to a sliding stop.
8. Complete 3 1/2 spins to the left
9. Run back to the middle of the arena past the center marker and come to a sliding stop
10. Back at least 10 feet in a straight line

VRH Ranch Reining Pattern 4

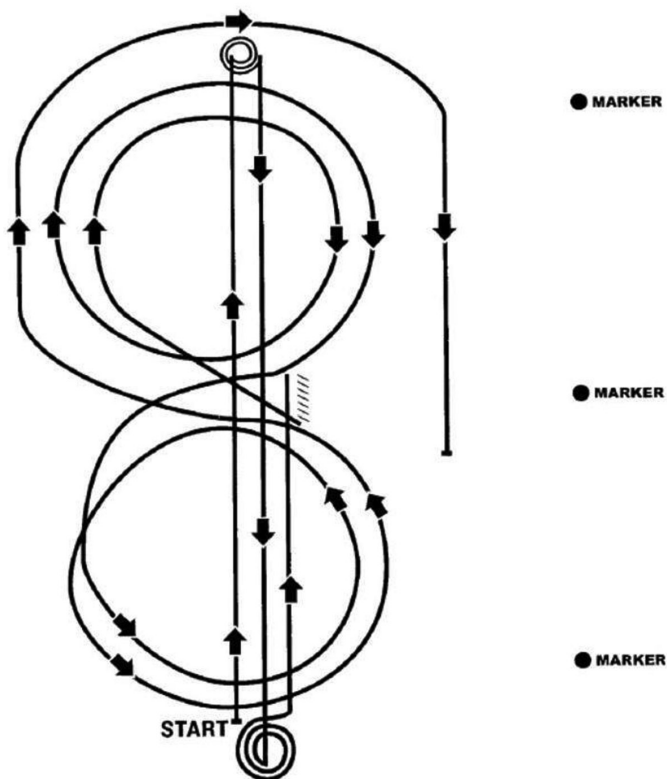

Mandatory Marker along Fence or Wall

The judge shall indicate with markers on arena fence or wall the center of pattern.

Ride pattern as follows:

1. Run up center of arena past the end marker and come to a sliding stop
2. Complete 3 1/2 spins to the left
3. Run down to other end of arena, past the end marker and come to a sliding stop.
4. Complete 3 1/2 spins to the right
5. Run past the center marker and stop.
6. Back at least 10 feet in a straight line
7. Complete 1/4 turn to the left, hesitate. Begin on right lead. Complete two circles to the right, the first one small and slow, the second large and fast. Change to left lead
8. Complete one small and slow circle then one large and fast circle. Change to right lead.
9. Run around end of arena to the other side, past the center marker, at least 20 feet from the fence and come to a sliding stop
10. Hesitate to complete pattern

VRH Ranch Reining Pattern 5

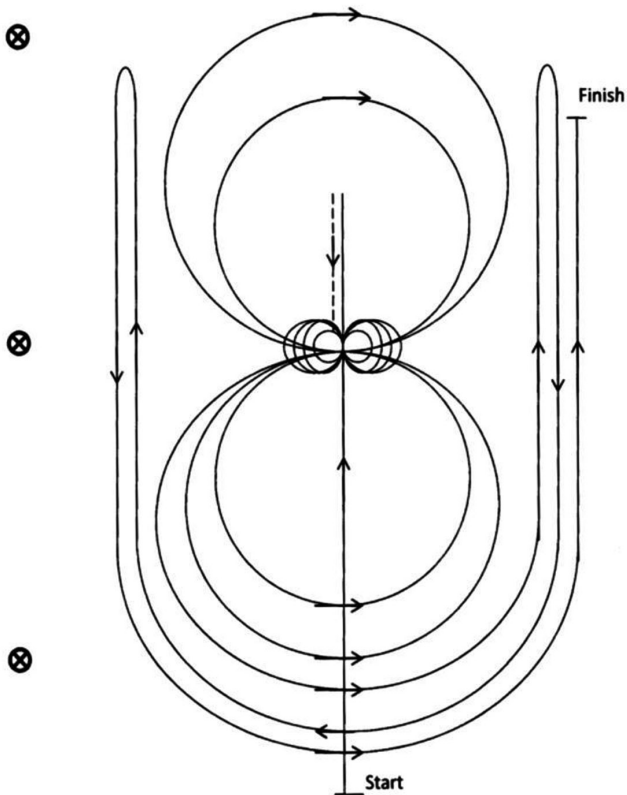

Mandatory Markers along Fence or Wall

The judge shall indicate the area for the pattern with six markers on arena fence.

Ride pattern as follows:

1. Run past the center marker and do a sliding stop. Back to center of arena or at least 10 feet. Hesitate.
2. Complete four right spins. Complete four and 1/4 left spins. Horse to be facing left fence at completion. Hesitate.
4. Beginning on the left lead, complete two circles to the left. First circle to be small and slow and second circle to be large and fast. Change leads at the center of the arena.
5. Complete two circles to the right. First circle to be small and slow and second circle to be large and fast. Change leads at center of arena.
6. Begin a large fast circle to the left. Do not close this circle. Run up the right side of the arena past the center marker and at least 20 feet from the fence. Do a right rollback.
7. Continue back around the previous circle, but do not close circle. RUN up the left side of the arena at least 20 feet from the fence and past the center marker. Do a left rollback.
8. Continue back around previous circle. Run up the right side of the arena at least 20 feet from the fence and past the center marker. Do a sliding stop. Hesitate to show completion of pattern.

VRH Ranch Reining Pattern 6

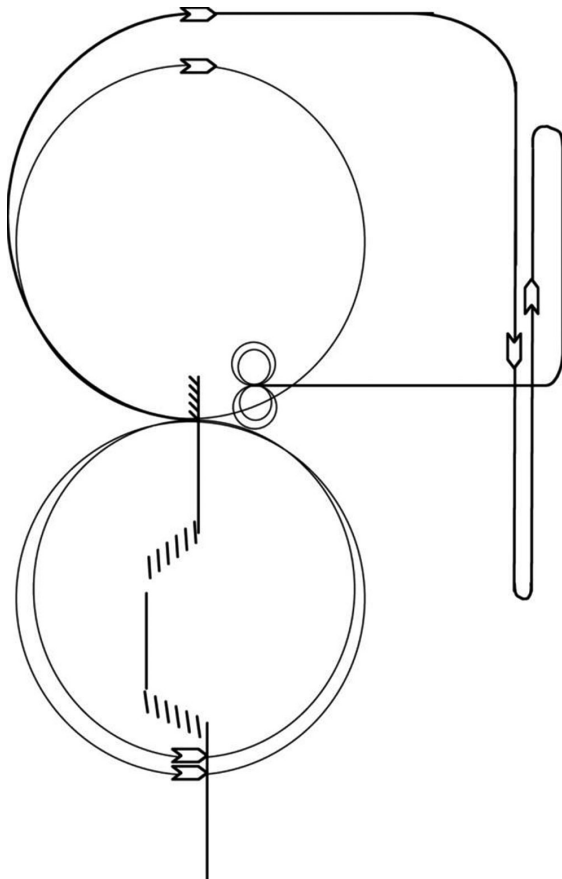

Ride pattern as follows:

1. Enter arena at sitting trot
2. Two-track left, trot straight, then two-track right
[Two-track is moving the horse forward and laterally simultaneously with bit contact. The horse's body is kept pointing straight in the direction indicated with the horse yielding laterally and forward to leg pressure.]
3. Move up to an extended trot
4. Stop and back; make left 90 degree pivot
5. Begin on right lead and lope one fast circle
6. Change leads; lope two fast circles to left
7. Change leads; lope, beginning a second right circle
8. Continue circle to wall and lope down wall
9. Make left roll back using wall as assistance
10. Lope straight down wall; Make right roll back using wall as assistance
11. Lope to middle of arena; stop
12. Make two spins each direction
13. Exit arena at a trot

VRH Ranch Reining Pattern 7

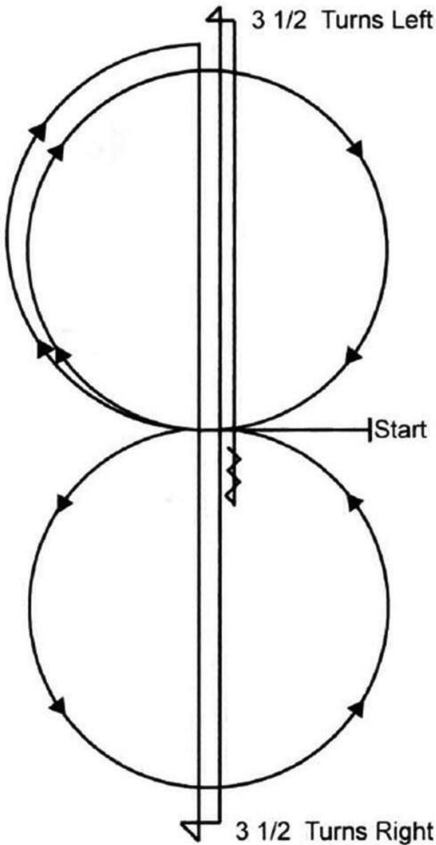

Mandatory Marker along Fence or Wall

The judge shall indicate with markers on arena fence or wall the center of pattern.

Ride pattern as follows:

1. Start by trotting into center of arena and stop. Start pattern facing toward judge.
2. Begin on right lead and lope one circle to the right. Change leads to the left.
3. Complete one circle to the left. Change leads to the right and go to the top of the arena.
4. Run down the center of arena to far end past the end marker and come to a sliding stop.
5. Complete 3 1/2 spins to the right
6. Run down to other end of arena, past the end marker, come to a sliding stop.
7. Complete 3 1/2 spins to the left
8. Run past the center marker and come to a sliding stop
9. Back at least 10 feet in a straight line
10. Hesitate to complete pattern

VRH Ranch Reining Pattern 8

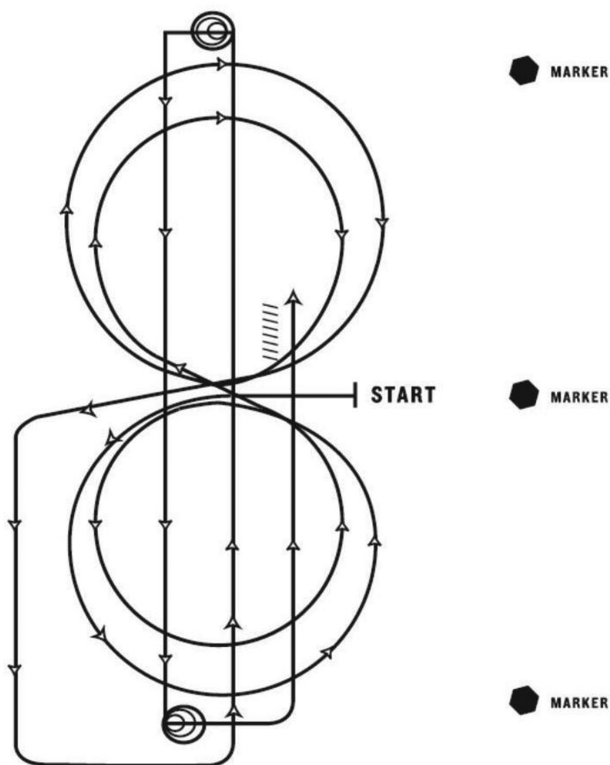

Mandatory Marker along Fence or Wall

The judge shall indicate with markers on arena fence or wall the center of pattern.

Ride pattern as follows:

1. Start by trotting into center of arena and stop. Start pattern facing toward judge.
2. Begin on left lead and complete two circles to the left, the first circle large and fast, the second circle small and slow. Change leads to the right
3. Complete two circles to the right, the first circle large and fast, the second circle small and slow. Change leads to the left
4. Continue around the end of arena without breaking gait or changing leads, run down the center of the arena past end marker and execute a square sliding stop.
5. Complete 3 1/2 spins to the left
6. Run down to other end of arena, past the end marker and execute a square sliding stop.
7. Complete 3 1/2 spins to the right
8. Run past the center marker and execute a square sliding stop.
9. Back at least 10 feet in a straight line
10. Hesitate to complete pattern

time has not elapsed and the judge is satisfied that all requirements of the class have been met, the judge should blow the whistle for the exhibitor to cease work. The judge may blow a whistle at any time for the exhibitor to cease work for safety reasons. Judges will give credit for what they have seen. Only the judge may award a new cow to a contestant to replace a cow that will not honor a horse. If the judge awards a new cow, the exhibitor has the option to refuse the new cow by continuing to work. If the exhibitor accepts the new cow, the time for working the cow will start over. If the exhibitor intends to accept the new cow, the exhibitor must pull up immediately. When multiple judges are scoring, any one of the judges may terminate the work or signal for a new cow.

SHW563.1 CONTENT. Exhibitors in the open, cowboy, amateur and youth divisions are allotted three minutes to complete the work. When there is one minute left, the announcer will announce, one minute remaining. At three minutes, the announcer will call for time. There are three parts to the class: boxing, fence work and roping or circling.

- Part One – Boxing the Cow: The rider shall ride into the arena, face the cattle entry gate and signal for their cow to be turned into the arena. The cow shall be controlled on the entry end of the arena for a sufficient amount of time to demonstrate the horse's ability to hold the cow. If the cow does not immediately challenge the horse, the rider shall aggressively move in on the cow to demonstrate his horse's ability to drive and block the cow on the entry fence.
- Part Two – Fence Work: After the cow has been controlled on the entry end of the arena, the rider shall set the cow up and drive it down either side of the arena. The cow should be turned on the fence at least once in each direction. The first run out for a turn shall be past the half-way mark of the arena. All turns down the side shall be completed before reaching the end fence.
- Part Three – Roping or Circling: The amateur and youth exhibitor has the option of circling the cow in the middle of the arena in both directions in lieu of roping. An amateur or youth exhibitor may circle or rope the cow but cannot combine the two to get credit for this portion of the run. Open and cowboy exhibitors must rope the cow.

To rope the cow, the exhibitor must be carrying a rope when the run starts. The exhibitor may pull up after the fence work, take down the rope and proceed to rope and stop the cow. The exhibitor must then rope the cow and bring it to a stop. In the roping portion of the class, two throws are permitted and the horse will be judged on three maneuvers: tracking, rating and stopping the cow. It is not necessary that the exhibitor catch to receive a score in the roping portion. The catch is legal as long as the cow looks through the loop and the rope pulls tight on any part of the animal's body except the tail. The rope may be tied on or dallied. If the exhibitor does not catch, the horse will be given credit for rating and tracking and will be assessed a 5 point penalty. For shows conducted in international countries, the exhibitor has the option of circling the cow each direction instead of roping or breakaway roping and wearing traditional attire of the country.

To circle the cow, the exhibitor will maneuver the cow

smoothly at least 360 degrees in each direction without interference from the fence. The circle's size, symmetry, speed and relative balance from right and left show control. Tightening the circles down with fast head-to-head speed will be a credit situation. The circles should be completed before the cow is exhausted. Once an exhibitor has committed to circling a cow, if the cow falls no new cow will be awarded. The exhibitor will complete the run by riding around the fallen cow to fulfill circling requirements. In the circling portion of the judging, one whistle will terminate the work and two whistles will award a new cow.

SHW563.2 CREDITS AND PENALTIES. All runs begin upon entering the pen; any infractions (such as two hands on the reins, using either hand to instill fear or praise, etc.) are subject to penalty at that time. During "Boxing", credit will be given for the horse's expression and its 'cow sense' (i.e., making moves with little rider assistance); holding, controlling, and turning the cow; the amount of work actually done; and the degree of difficulty of the work. Credit will be given during "Fence Work" for making the first run past the center of the arena; making turns right on the cow; and controlling a difficult cow. If "Roping", credit will be given for rating and following cow to allow rider the optimal roping position; stopping hard; and staying in the ground during the hold. Credits for each element of Roping range from -1 1/2 to +1 1/2 points. If "Circling", credit will be given when the horse works willingly; acknowledges the cow; and gets close enough to the cow to control the circles. Credits for Circling range from -1 1/2 to +1 1/2 points for each direction. Penalties will be assessed as follows:

- 1 Point Penalties: Loss of working advantage ; Using the corner or the end of the arena to turn the cow when going down the fence; changing sides of arena to turn cow; for each length horse runs past cow; working out of position; slipping rein; failure to drive cow past middle marker on first turn.
- 2 Point Penalties: Going around the corner of the arena before turning cow; when working an animal in the open field (at least 20' from the side of arena) and the animal gets within 3 feet from the end fence before being turned.
- 3 Point Penalties: Exhausting or overworking the cow before circling or roping; hanging up on the fence (refusing to turn); performing two loop run; knocking down the cow without having a working advantage; losing a cow while boxing
- 5 Point Penalties: Failure to turn the cow both directions on the fence; failure to catch; spurring in front of cinch; Blatant disobedience; use of either hand to instill fear/praise; use of two hands (except in snaffle bit or hackamore) per maneuver; more than one finger between split reins or any fingers between romal reins (except two rein) per maneuver.
- Off-Pattern (OP): Turning tail; failure to attempt any part of the class; leaving arena before run is complete; repeated blatant disobedience; fall of horse/rider (run ends, credit will be given for work done); schooling after entering the arena prior to calling for cow; schooling horse

between cows, if new cow is awarded; cannot place above others who complete pattern correctly.

- Disqualification (DQ): lameness, abuse, illegal equipment, disrespect or misconduct, improper western attire

If the open or cowboy rider runs out of time to rope, there will be no credit for the stop/hold maneuver and a 5 point penalty for failure to catch. Riders may still earn credit for control/position/rate and speed/degree of difficulty.

SHW564. LIMITED RANCH COW WORK AMATEUR/YOUTH.

SHW564.1 Content. Exhibitors in the limited ranch cow work cannot compete in both the ranch cow work and limited cow work class. An exhibitor is eligible to compete in limited ranch cow work if they have never shown three or more times down the fence in any judged class. Any amateur or select rider may fall back one time to the limited ranch cow work. Limited ranch cow work exhibitors are allotted one minute and forty-five seconds to complete the work. There are three parts to the work: boxing the cow; setting up the cow and driving it down the fence to the opposite end of the arena; and boxing it at the opposite end of the arena. There is no expectation that the exhibitor will make a 'fence turn', rather the drive down the fence demonstrates correct position and control around the corner.

- Part One – Boxing the Cow – The rider shall ride into the arena, face the cattle entry gate, and signal for their cow to be turned into the arena. The cow shall be controlled on the entry end of the arena for a sufficient amount of time to demonstrate the horse's ability to "hold" the cow. If the cow does not immediately challenge the horse, the rider shall aggressively move in on the cow to demonstrate his horse's ability to drive and block the cow on the entry fence.
- Part Two - Set Up Cow and Drive Down Fence to Opposite End of Arena – After the cow has been controlled on the entry end of the arena, the rider shall set the cow up for driving down the side of the arena. When coming out of corner, the horse shall be close enough to cow to demonstrate control with cow against the fence. This distance and control should be maintained for approximately 1/2 to 3/4 the length of arena. Rider will then stop and release the cow and move horse toward center of arena to set the cow up for boxing.
- Part Three – Boxing the Cow at Opposite End of Arena – The exhibitor will again control or "hold" the cow for the remainder of time at end of the arena to demonstrate the horse's ability to "hold" the cow.

SHW564.2 Credits and Penalties. All runs begin upon entering the pen; any infractions (such as two hands on the reins, using either hand to instill fear or praise, etc.) are subject to penalty at that time. During "Boxing", credit will be given for the horse's expression and its 'cow sense' (i.e., making moves with little rider assistance); holding, controlling, and turning the cow; the amount of work actually done; and the degree of difficulty of the work. Credit will be given during "Set Up Cow and Drive Down Fence" for rating the cow; blocking the cow with pressure towards the end of the arena; driving the cow with con-

trol down the side of the arena; and controlling a difficult cow. Penalties will be assessed as follows:

- 1 Point Penalties: Loss of working advantage; working out of position; slipping rein
- 3 Point Penalties: Knocking down the cow without having a working advantage; losing a cow while boxing.
- 5 Point Penalties: Spurring in front of cinch; blatant disobedience; use of either hand to instill fear/praise; use of two hands (except in snaffle bit or hackamore) per maneuver; more than one finger between split reins or any fingers between romal reins (except two rein) per maneuver.
- Off-Pattern (OP): Turning tail; failure to attempt any part of the class; leaving arena before run is complete; repeated blatant disobedience; fall of horse/rider (run ends, credit will be given for work done); schooling after entering the arena prior to calling for cow; schooling horse between cows (if new cow is awarded); cannot place above others who complete pattern correctly.
- Disqualification (DQ): lameness, abuse, illegal equipment, disrespect or misconduct, improper western attire

SHW565. VRH RANCH CUTTING. This class is judged on the ability of the horse to work a cow by separating it from the herd and holding it to demonstrate the horse's ability to work the cow. A single cow is cut from the herd and the horse must demonstrate its ability to work the cow.

SHW565.1 Objective will be to cut one or two cows, based on the division, from the herd and work the cow(s) with the assistance of two turn-back riders and two herd holders. Show management may supply two herd holders and two turn back riders, or exhibitors may supply their own helpers. If an exhibitor is a herd holder or turn back rider, he or she may use the horse that they are competing on, or use a different horse. Herd holders' and turn back riders' horses should be American Quarter Horses.

SHW565.2 For open, cowboy and amateur division competition, there will be a two minute limit. Each exhibitor must work two head, but has the option of working the full two minutes. For international countries, show management has the option of allowing exhibitors to work the two head or there may be a one and one-half time limit and work only one head.

SHW565.3 For youth competition, there will be a one and half minute time limit. Exhibitor must work one cow but has the option of working the full minute and a half.

SHW565.4 Time will begin when a rider crosses a time line just prior to entering the herd. Time should not start until contestant crosses a pre-determined and marked timeline. The rider will then quietly separate his/her cow from the herd.

SHW565.5 Unnecessary roughness or disturbing the herd excessively could result in disqualification.

SHW565.6 Credit will be given to those horses who demonstrate excellence in their herd work, driving and setting up the cow to cut, working in the center of the arena, and degree of difficulty of the cow drawn, within the two minutes.

SHW565.7 Horses will not be penalized for reining during the cutting portion, but should display natural ability.

SHW565.8 The hot quit shall be considered in the run con-

tent.

SHW565.9 Scoring: 100 percent will be judged by the horse's performance and natural ability. If time and number of cattle permit, the judge may, at his discretion, award new cattle, to enable the contestant to show his horse's ability on the cow.

SHW565.10 Penalties should be assessed as follows:

- One (1) point
 - losing working advantage toe, foot or stirrup on the shoulder working out of position
- Three (3) points
 - cattle picked up or scattered spurring on shoulder pawing or biting cattle back fence
- Five (5) points
 - quitting cow
 - losing cow
- Score - 0
 - illegal equipment
 - excessive disturbance of herd to the point that exhibitor is asked to leave the arena

SHW566. VRH RANCH CONFORMATION. The purpose of ranch conformation is to preserve American Quarter Horse type by selecting well-mannered individuals in the order of their resemblance to the breed ideal and that are the most positive combination of balance, structural correctness, and movement with appropriate breed and sex characteristics and adequate muscling. The ranch conformation class must be held after the conclusion of the other four events, except at the AQHA All-Around Ranch Horse World Championship Show.

SHW566.1 To be eligible to compete in the ranch conformation class the horse must be shown in at least one class one of the other categories the day of the show.

SHW566.2 All horses will be shown together as one class:

- Open/Amateur: stallions, mares and geldings
- Youth/Level I amateur: mares and geldings

SGW566.3 Horses are to be shown in a good working halter: rope, braided, nylon or plain leather. Horses will walk to the judge one at a time.

SHW566.4 As the horse approaches, the judge will step to the right to enable the horse to trot straight to a cone place 50 feet away. At the cone, the horse will continue trotting, turn to the left and trot toward the left wall or fence of the arena. After trotting, horses will be lined up head to tail for individual inspection by the judge.

SHW566.5 The judge shall inspect each horse from both sides, front and rear and place the horses in order of preference.

SHW600. LEVEL 1 HUNTER UNDER SADDLE. The purpose of Level 1 hunter under saddle is to allow a horse to compete in a field with minimally accomplished horses of the same level of experience. The Level 1 hunter under saddle is a stepping-stone to the more advanced competition of Level 2 /Level 3. Horses must be ridden with equipment that is approved as per AQHA equipment rules for hunter under saddle.

SHW600.1. With the exception of eligibility requirements, the same rules apply in Level 1 hunter under saddle as apply in hunter under saddle.

SHW600.2 Horses are eligible to compete if they have not, as of January 1 of the current show year:

SHW600.2.1 won 25 points or more in AQHA-approved hunter under saddle classes (horse points from all levels in any division will count including introductory/rookie points and are cumulative in determining eligibility); or

SHW600.2.2 won \$1,000 or more in any equine organization or association in hunter under saddle classes.

SHW600.2.3 Accuracy of eligibility is the responsibility of the owner or exhibitor.

SHW601. HUNTER UNDER SADDLE. The purpose of the hunter under saddle horse is to present or exhibit a horse with a bright, alert expression, whose gaits show potential of being a working hunter. Therefore, its gait must be free-flowing, ground covering and athletic. Hunters under saddle should be suitable to purpose. Hunters should move with long, low strides reaching forward with ease and smoothness, be able to lengthen stride and cover ground with relaxed, free-flowing movement, while exhibiting correct gaits that are of the proper cadence. The quality of the movement and the consistency of the gaits is a major consideration. Horses should be obedient, have a bright expression with alert ears, and should respond willingly to the rider with light leg and hand contact. Horses should be responsive and smooth in transition. When asked to extend the trot or hand gallop, they should move out with the same flowing motion. The poll should be level with, or slightly above, the withers to allow proper impulsion behind. The head position should be slightly in front of, or on, the vertical.

SHW601.1 This class will be judged on performance, condition and conformation. Maximum credit shall be given to the flowing, balanced, willing horse.

SHW601.2 Horses may be asked to change to canter from the flat-footed walk or trot, at the judge's discretion.

SHW601.3 At the option of the judge, all or just the top 12 horses may be required to hand gallop, one or both ways of the ring. Never more than 12 horses to hand gallop at one time. At the hand gallop, the judge may ask the group to halt and stand quietly on a free rein (loosened rein).

SHW602. Horses to be:

SHW602.1 shown under saddle, not to jump.

SHW602.2 shown at a walk, trot and canter both ways of the ring. Horses should back easily and stand quietly.

SHW602.3 reversed to the inside away from the rail.

SHW603. Faults scored according to severity:

Quick, short or vertical strides

Being on the wrong lead

Breaking gait
Excessive speed at any gait
Excessive slowness in any gait, loss of forward momentum
Failure to take the appropriate gait when called for
Head carried too high
Head carried too low (such that poll is below the withers)
Overflexing or straining neck in head carriage so the nose is carried behind the vertical
Excessive nosing out
Failure to maintain light contact with horse's mouth
Stumbling
If a horse appears sullen, dull, lethargic, emaciated, drawn or overly tired
Consistently showing too far off the rail

SHW604. Faults which will be cause for disqualification, except in Level I amateur or Level I youth, which shall be faults scored according to severity:

Head carried too low and/or clearly behind the vertical excessively and consistently while the horse is in motion, or otherwise showing the appearance of intimidation.

SHW610. PLEASURE DRIVING. The purpose of the class is to evaluate the horse's ability and pleasurable attitude while pulling a cart. The horse should have an engaged trot with more impulsion and a long ground covering stride. Style, conformation and safety are paramount in this class. A pleasure driving horse should carry himself in a natural balanced position with a relaxed head and neck. His poll should be level with, or slightly above the level of the withers.

SHW610.1 Horses shall enter the ring in the same direction. Each horse shall then be exhibited at the walk, park gait and road gait in both directions of the show ring. At the direction of the ring steward, such change of direction shall be accomplished by the horses crossing the show ring on the diagonal while walking only. The recommended class procedure is walk, park gait, road gait, park gait and walk.

SHW610.2 Each horse shall also be required to back easily and straight and stand quietly.

SHOW610.3 Horses must be shown with natural American Quarter Horse hoofs and standard shoes. No extended hoofs, heavy shoes or toe weights allowed.

SHW610.4 No exhibitor shall drive a horse while standing, kneeling or using a seat extension in the cart at any time. An exhibitor may momentarily rise if circumstances warrant. No horse shall be unbridled or unattended while hooked to a cart. Excessive noise making by exhibitors shall be penalized according to severity.

SHW610.5 This class will be judged 80 percent on the horse's performance and suitability for assuring a pleasurable drive, with a maximum of 20 percent on condition and conformation.

SHW610.6 Maximum credit should be given to a horse that moves straight, with free movement, manners and a bright expression.

SHW610.7 The horse shall be severely penalized if he carries his head behind the vertical, is over flexed, excessively nosed out, the poll is below the withers or exhibits lack of control by exhibitor.

SHW610.8 Consistently showing too far off the rail shall be penalized according to severity.

SHW616. HUNT SEAT EQUITATION ON THE FLAT. Available only in the amateur and youth divisions. The purpose is to evalu-

ate the ability of the hunter rider to perform various maneuvers on his/her horse which provides a base for natural progression to over fence classes. The communication between horse and rider through subtle cues and aids should not be obvious. Equitation is judged on the rider and his/her effect on the horse. Hunt seat equitation on the flat provides a base for a natural progression to over fence classes. The poll should be level with, or slightly above the withers, to allow proper impulsion behind. The head should not be carried behind the vertical, giving the appearance of intimidation, or be excessively nosed out, giving a resistant appearance.

SHW617. Pattern. It is mandatory that the judge post the pattern at least one hour prior to commencement of the class. The pattern should be designed so the majority of exhibitors can perform it in a reasonable length of time (under 60 seconds). All patterns must include a trot and canter. Patterns used in classes for riders 13 and under should use maneuvers from Group #1 and/or Group #2 [SHW620]. Horses' gaits are to be ridden with the same cadence and speed as you would find in the rail phase. All ties will be broken at the discretion of the judge.

SHW618. Basic Position. To mount, take up reins in left hand and place hand on withers. Grasp stirrup leather with right hand and insert left foot in stirrup and mount. To dismount, rider may either step down or slide down. The size of rider must be taken into consideration.

SHW618.1 Hands should be over and in front of horse's withers, knuckles 30 degrees inside the vertical, hands slightly apart and making a straight line from horse's mouth to rider's elbow. Method of holding reins is optional, and bight of reins may fall on either side. However, all reins must be picked up at the same time.

SHW618.2 The eyes should be up and shoulders back.

SHW618.3 Toes should be at an angle best suited to rider's conformation; heels down, calf of leg in contact with horse.

SHW618.4 Iron should be on the ball of the foot. Iron or stirrup leather may not be connected by string or any other material to the girth.

SHW619. Class Procedure: Exhibitors may be worked individually from the gate or they may all enter at once, but a working order must be drawn regardless. The entire class, or only the finalists, must work at all three gaits at least one direction of the arena. Rail work can be used to break ties and possibly adjust placings.

SHW619.1 A turn on the forehand to the right is accomplished by moving haunches to the left.

SHW619.2 A forehand turn to the left is accomplished by moving haunches to the right.

SHW619.3 If riders are asked to drop their irons, they can leave them down or cross them over the withers.

SHW619.4 When performing a leg-yield, the horse should move forward and lateral in a diagonal direction with the horse's body straight with a slight flexion of the head in the opposite direction of lateral movement. When a horse yields to the right, the head is slightly (just to see the eye of the horse) to the left. A horse yielding to the left, the head is slightly flexed to the right.

SHW620. Individual works may be comprised of any of the following: **Group #1** - Walk, Sitting Trot, Extended Trot, Posting Trot, Canter, Circles, Figure 8, Halt, Back, Sidepass, Address Reins, Demon-

strate Change of Diagonal; **Group #2** - Serpentine (Trot or Canter), Turn on Haunches or Forehand, Leg-Yield, Flying or Simple Change of Lead; or **Group #3** - Canter and Hand Gallop in a straight or curved line, Counter-Canter Figure 8, Drop or Pick-up Irons without stopping.

SHW620.1 THE WALK: Should be a four-beat gait with the rider in a vertical position with a following hand.

SHW620.2 THE POSTING TROT: Figure 8 at trot, demonstrating change of diagonals. At left diagonal, rider should be sitting the saddle when left front leg is on the ground; at right diagonal, rider should be sitting the saddle when right front leg is on the ground; when circling clockwise at a trot, rider should be on left diagonal; when circling counter-clockwise, rider should be on right diagonal. The rider should close his/her hip angle to allow his/her torso to follow the horizontal motion of the horse. The upper body should be inclined about 20 degrees in front of the vertical.

SHW620.3 SITTING TROT AND CANTER: At the sitting trot, the upper body is only slightly in front of the vertical. At the canter, the body should be positioned slightly more in front of the vertical. As the stride is shortened, the body should be in a slightly more erect position.

SHW620.4 TWO-POINT POSITION: The pelvis should be forward, but relaxed, lifting the rider's weight off the horse's back and transferring the weight through the rider's legs. In this position the two points of contact between horse and rider are the rider's legs. Hands should be forward, up the neck, not resting on the neck.

SHW620.5 HAND GALLOP: A three-beat, lengthened canter ridden in two-point position. The legs are on the horse's sides while the seat is held out of the saddle. When at the hand gallop, the rider's angulation will vary somewhat as the horse's stride is shortened and lengthened. A good standard at a normal hand gallop should be about 30 degrees in front of the vertical.

SHW621. SCORING: Exhibitors are to be scored from 0 to 100 with 70 denoting an average score. It is suggested a minimum score of 50 be administered except for disqualifications. One-half point increments are acceptable. Maneuver scores will be indicated as follows:

- + = Very Good
- √ + = Good
- √ = Correct
- √ - = Poor
- = Very Poor

An additional + (excellent) or - (well below average) may be given.

SHW621.1 FINAL SCORING shall be on a basis of 0-100 with 70 denoting an average score. It is with an approximate breakdown as follows:

90-100 Excellent equitation, including body position and use of aids. Completes pattern accurately, quickly, smoothly and precisely; demonstrates a high level of professionalism.

80-89 Very good rider that executes the pattern as well as correct equitation and use of aids. Excellent rider that commits one major fault.

70-79 Good pattern execution and average equitation but lacking adequate style and professional presentation to merit elevating to the next scoring range. A very good rider that commits a major fault or an excellent rider who commits a

severe fault.

60-69 Fair pattern that lacks quickness or precision. Rider has obvious position and/or appearance faults that prevents effective equitation. A good rider that commits one major fault, or a very good rider that commits a severe fault in the performance of the pattern.

Less than 59 Good rider that commits one severe fault or multiple major and/or minor faults; excellent or very good rider that commits multiple, and/or combination of, severe, major, or minor faults in the performance. A rider that demonstrates a lack of riding ability and knowledge of correct body position

SHW621.2 Faults can be classified as minor, major or severe. The judge will determine the appropriate classification of a fault based upon the degree and/or frequency of the infraction. An exhibitor that incurs a severe fault avoids elimination, but should be placed below all other exhibitors that complete the pattern correctly. A minor fault can become a major fault and a major fault can become a severe fault when the degree and/or frequency of the infraction(s) merits.

SHW621.2.1 Minor faults - Deduction of 5 points

Break of gait at walk or trot up to two strides

Over/under turn of 1/8 to 1/4

Tick or hit of cone

Obviously looking down to check leads or diagonals

SHW621.2.2 Major faults - Deduction of 10 points

Not performing the specific gait or not stopping when called for in the pattern within 10 feet (3 meters) of the designated location

Missing a diagonal up to 2 strides in the pattern or on the rail
Incorrect lead or break of gait (except when correcting an incorrect lead at the canter)

Complete loss of contact between rider's hand and the horse's mouth

Break of gait at walk or trot for more than two strides

Loss of iron

Head carried too low and/or clearly behind the vertical while the horse is in motion, showing the appearance of intimidation

SHW621.2.3 Severe Faults - Deduction of 20 points

(avoids disqualification but should be placed below other exhibitors that do not incur a severe fault) include:

loss of rein

Missing a diagonal for more than two strides

Use of either hand to instill fear or praise while on pattern or during rail work

Holding saddle with either hand

Spurring or use of crop in front of girth

Blatant disobedience including kicking, pawing, bucking and rearing

SHW621.2.4 Disqualifications (should not be placed) include:

failure by exhibitor to wear correct number in visible manner
willful abuse

excessive schooling or training

fall by horse or rider

illegal use of hands on reins
use of prohibited equipment
knocking over the cone, going off pattern or working on wrong side of cone
failure to follow pattern correctly, including failure to ever execute correct lead or gait where called for overturning more than 1/4 of prescribed turn

SHW622. Rookie/LEVEL I Classes Only. Exhibitor going off pattern, knocking over or on wrong side of cone, never performing specified gait, or overturning more than 1/4 turn than designated, shall not be disqualified, but must always place below exhibitors not incurring a disqualifying fault.

SHW622.I Faults, which will be cause for disqualification, except in Level I amateur or Level I youth classes, which shall be faults, scored according to severity:

Head carried too low and/or clearly behind the vertical excessively and consistently while the horse is in motion, or otherwise showing the appearance of intimidation.

SHW625. HUNTER HACK. The purpose of hunter hack is to give horses and opportunity to show their expertise over low fences and on the flat. The hunter hack horse should move in the same style as a working hunter. The class will be judged on style over fences, even hunting pace, flat work, manners and way of going. The poll should be level with, or slightly above the withers, to allow proper impulsion behind. The head should not be carried behind the vertical, giving the appearance of intimidation, or be excessively nosed out, giving a resistant appearance.

SHW625.I Horses are first required to jump two fences, two feet three inches (68.5 cm) to three feet (90 cm). **Show management has the option to allow a third fence;** however, if the jumps are set on a line, they are recommended to be in increments of 12 feet (3.5 meters) but adjusted to no less than two strides. A ground line is recommended for each jump.

SHW625.2 Horses being considered for placing are then to be shown at a walk, trot and canter both ways of the ring with light contact.

SHW625.3 At the discretion of the judge, contestants may be asked to hand gallop, pull up or back and stand quietly following the last fence.

SHW625.4 When necessary to split large classes by running more than one go-round, finalists must both be re-jumped and reworked on the flat.

SHW625.5 Placing for the class shall be determined by allowing a minimum of 70 percent for individual fence work and a maximum of 30 percent for work on the flat.

SHW625.6 Faults over fences will be scored as in the working hunter class. Horses eliminated in the over-fence portion of the class shall be disqualified.

SHW626. Faults to be scored accordingly, but not necessarily cause disqualification during the rail work, include:

Being on wrong lead and/or wrong diagonal at the trot
Excessive speed (any gait)
Excessive slowness (any gait)
Breaking gait
Failure to take gait when called
Head carried too low or too high

Nosing out or flexing behind the vertical
Opening mouth excessively
Stumbling

SHW627. Faults which will be cause for disqualification, except in Level I amateur or Level I youth classes, which shall be faults, scored according to severity:

Head carried too low and/or clearly behind the vertical excessively and consistently while the horse is in motion, or otherwise showing the appearance of intimidation.

SHW630. LEVEL I WORKING HUNTER. The purpose of Level I working hunter is to allow a horse to compete in a field with minimally accomplished horses of the same level of experience. The Level I working hunter is a stepping-stone to the more advanced competition of Level 2 /Level 3. Fence heights shall be two feet six inches (76cm) to two feet nine inches (85cm).

SHW630.1 With the exception of eligibility requirements and heights of the jumps, the same rules apply in Level I working hunter class as apply in working hunter.

SHW630.2 Horses are eligible to compete if they have not, as of January 1 of the current show year:

SHW630.2.1 won 25 points or more in Level I working hunter or won a \$1,000 or more in any equine organization or association in working hunter classes

SHW630.2.2 exhibited in the following classes with AQHA or any other equine organization or association: working hunter (other than AQHA Level I Working Hunter), equitation over fences or jumping.

SHW630.2.3 If a horse meets above eligibility requirements as of January 1 of the current show year, but subsequently enters any working hunter, equitation over fences or jumping class with any equine organization or association, such horse shall remain eligible to compete in Level I working hunter classes, but only for the remainder of the current show year.

SHW630.2.4 If a horse meets the above eligibility requirements as of January 1 of the current show year, but subsequently enters any AQHA-approved working hunter (other than the AQHA Level I Working Hunter), equitation over fences or jumping class, such horse shall remain eligible to compete in Level I working hunter classes but only for the remainder of the current show year.

SHW630.2.5 Accuracy of eligibility is the responsibility of the owner or exhibitor.

SHW635. PROGRESSIVE WORKING HUNTER. The purpose of the Progressive working hunter is the next step in the progression from the Level I working hunter to the more advanced level of competition with the seasoned horse. This class should be judged according to the purpose of its intent.

SHW635.1 Eligibility: Horses of all ages that have not earned 10 points in AQHA-approved working hunter classes excluding Level I working hunter points. A horse is eligible to complete only one time in the Progressive working hunter class at the AQHA World Show.

SHW635.2 Fence heights shall be two feet nine inches (85 cm).

SHW636. WORKING HUNTER. The working hunter is a representative of the type of horse used in the hunt field. He should possess manners, jumping ability, style, pace and quality. The working hunter

must be able to demonstrate his ability to furnish the rider with a smooth comfortable and safe ride. The same rules apply in junior working hunter as apply in senior or all-ages working hunter classes, except the minimum height of obstacles.

SHW636.I A hunter course shall be any course that management deems a fair test of a hunter. Judges are responsible for correctness of each course after it has been set and shall call the show management's attention to any errors that would tend to result in unfair or inappropriate courses. The judge must walk the course and has the right and duty to alter the course in any manner to ensure its safety. The judge may remove or change any obstacle he deems unsafe or non-negotiable.

SHW636.I.I The handy hunter course is an optional course design for show management. The class is still judged on the performance, even hunter pace, jumping style and quality. Also included are the movement, handiness and brilliance of pace. Handiness is defined as ground-saving movement without adversely affecting performance and style. Different elements that might be seen in a handy hunter course are gallop jumps, option jumps, rollbacks and trot jumps.

SHW636.I.2 At the option of show management, handy hunter maybe offered in the junior, senior, amateur and/or youth class. This class is not recommended for level I , progressive horses or novice rider classes.

SHW636.2 There will be a minimum five minute warm-up period after the course walk is closed before the first competitor is called to the ring to compete.

SHW636.3 Circling once upon entering the ring is permissible.

SHW636.4 Horses shall not be requested to rejump the course.

SHW636.5 Manners shall be emphasized in youth and amateur classes.

SHW636.6 When an obstacle is composed of several elements, any disturbance of these elements will be penalized; however, only a reduction in height of the top element shall be considered a knockdown.

SHW636.7 In cases of broken equipment, the rider may either continue without penalty, or stop and correct the difficulty and be penalized the same as any loss of forward impulsion.

SHW636.8 When an obstacle requires two or more fences (in and out), faults committed at each obstacle are considered separately. In case of a refusal or runout at one element, entry must re-jump the previous elements.

SHW636.9 The course must be posted at least one hour before scheduled time of class.

SHW636.10 It is mandatory that a schooling area with at least one practice jump or practice time in the arena be provided.

SHW636.II Schooling over obstacles in the ring or over any part of an outside course is permitted only at the time designated by show management.

SHW637. Course or Arena Arrangement. One change of direction is mandatory. Minimum of four obstacles. Horses to jump a minimum of eight fences.

SHW637.I Obstacles which may be used: fences shall simulate obstacles found in the hunting field, such as natural looking post and rail, brush, walls, coops and ascending oxers (not square). Triple bar and hogsback are prohibited. Striped poles are not recom-

mended; PVC poles used as rails are not permitted.

SHW637.2 The top element of all fences must be securely placed so that a slight rub will not cause a knockdown. It is recommended, but not required, to use FEI approved safety cups of breakable pins in the schooling/warm up ring and on all fences in the show arena.

SHW637.3 Distance between fences is recommended to be in 12-foot (3.5 meters) increments with the exception of some combinations: one stride in and out, 24-26 feet (7 meters); two strides in and out, 36 feet (11 meters); three strides, 48 feet (14.5 meters);

SHW637.4 The use of wings on obstacles in hunter classes is recommended; standards made of PVC material must be anchored or properly secured.

SHW637.5 Jump standards with hole heights at three inch (75 mm) intervals with jump cups are recommended.

SHW638. Fence Heights. A variation of three inches (75 mm) in fence height, lower than official heights listed below, may be instituted if show management and the judge feel circumstances warrant, i.e., footing, weather, etc.

SHW638.1 Minimum height for junior, horses, youth and amateur classes must be two feet nine inches (88 cm), with a maximum of three feet (91 cm).

SHW638.2 Minimum heights for senior horses must be three feet (91 cm), with a maximum of three feet three inches (1 meter).

SHW638.3 Minimum heights all-ages must be a two feet nine inches (88 cm) with a maximum of three feet three inches (1 meter).

SHW638.4 Minimum height for Level I and select will be two feet six inches (76 cm) with a maximum of two feet nine inches.

SHW638.5 Fence height for Progressive Working Hunter shall be two feet nine inches (88 cm)

SHW639. Scoring. Scoring to be judged on manners, way of going and style of jumping. Horses shall be credited with maintaining an even hunting pace that covers the course with free-flowing strides. Preference will be given to horses with correct jumping style that meet fences squarely, jumping at the center of fence. Judges shall penalize unsafe jumping and bad form over fence, whether touched or untouched, including twisting. Incorrect leads around the ends of the course or cross-cantering shall be penalized, as well as excessive use of crop. In and outs (one or two strides) shall be taken in the correct number of strides or be penalized. Any error which endangers the horse and/or its rider, particularly refusals or knockdowns, shall be heavily penalized.

SHW639.1 Scoring shall be on a basis of 0-100, with an approximate breakdown as follows:

90-100: an excellent performer and good mover that jumps the entire course with cadence, balance and style.

80-89: a good performer that jumps all fences reasonably well; an excellent performer that commits one or two minor faults.

70-79: the average, fair mover that makes no serious faults, but lacks the style, cadence and good balance of the scoper horses; the good performer that makes a few minor faults.

60-69: poor movers that make minor mistakes; fair or average movers that have one or two poor fences but no major faults or disobediences.

50-59: a horse that commits one major fault, such as a hind knockdown, refusal, trot, cross-canter or drops a leg.

30-49: a horse that commits two or more major faults, including front knockdowns and refusals, or jumps in a manner that otherwise endangers the horse and/or rider.

10-29: a horse that avoids elimination but jumps in such an unsafe and dangerous manner as to preclude a higher score.

SHW639.2 The following will result in elimination:

A total of three disobediences that can include any of the following: refusal, stop, run out or extra circle.

Jumping an obstacle before it is reset.

Bolting from the arena.

Off course.

Deliberately addressing an obstacle.

Failure to trot the horse in a small circle on a loose rein for soundness, after jumping the last fence, while still mounted and prior to leaving the arena.

SHW639.3 Disobediences/Major faults. Refer to JUMPING; excluding refusal on an in-and-out jump.

SHW645. HUNT SEAT EQUITATION OVER FENCES.

Available only in the amateur and youth divisions. The purpose of this event is to evaluate amateur and youth rider's correctness and ability over the fences. This class should be judged on the precision of riding ability while executing the jumps. The class objective is to judge the rider's ability over the fences, not the horse. Only the effect the rider has on a horse is to be considered. How a rider elects to ride the course, the pace and approach to the jumps are used to evaluate the rider's judgment and ability.

SHW645.1 Position. Refer to HUNT SEAT EQUITATION ON THE FLAT; BASIC POSITION.

SHW646. Course requirements. Course is to be posted one hour prior to the class.

SHW646.1 At least four obstacles are required and horses must jump a minimum of six fences.

SHW646.2 Refer to WORKING HUNTER regarding hunter courses which should be offered enabling the rider to be judged on their ability to establish and maintain an even hunting pace.

SHW646.3 At least one change of direction is required.

SHW646.4 Minimum height of fences must be 2'6" (79 cm), with a maximum height of 3' (91.4 cm). Except in Level I and Select classes where the maximum height is 2'9" (83.8 cm).

SHW646.5 It is recommended that show management offer this class prior to its corresponding working hunter class.

SHW647. Class Routine. The exhibitor is being judged as soon as he/she enters the arena.

SHW647.1 Exhibitors have the option of entering the arena at any gait (unless otherwise stated on the course), making transition to canter from halt, walk or trot before approaching the first fence.

SHW647.2 Each competitor may circle once before approaching the first obstacle, then proceed around the course keeping an even pace throughout. If a rider steps into the obvious wrong lead for one or two strides only before or on the courtesy circle, it is noted on the score sheet, which may be used as a tie breaker in the event of a ride of equal quality and score.

SHW647.3 Rider must obtain correct lead to properly turn

around end of arena before breaking into final trot circle. The class is not over until the exhibitor trots a circle and walks out of the ring. Riders should leave the arena at a walk unless otherwise instructed.

SHW647.4 Except for refusals, jumping faults of the horse are not to be considered unless it is the result of the rider's ability. If a refusal occurs in a double or triple, competitors must re-jump all obstacles in the combination.

SHW647.5 In cases of broken equipment or loss of shoe, competitor must continue or be eliminated.

SHW647.6 An exhibitor may enter the class only one time.

SHW648. SCORING may be on a basis of 0-100, with an approximate breakdown as follows:

90-100: Excellent equitation, position and presentation; meets all fences squarely and at proper distance. Uses all options to their advantage.

80-89: Minor equitation faults, i.e., long, weak distance, deep distance, one step landing at counter-canter. Rider still maintains a quality ride.

70-79: More problems occur, equitation suffers, i.e., rounded shoulders, heels are not down, hands incorrect, lacks the style and presence. One major fence problem, i.e., chip with a ride up the neck, or discreet swap out, jumping off one side of jump. No dangerous fences, not a flowing course.

60-69: Major equitation faults, poor body position, loose legs and seat, failure to obtain or maintain trot to a trot fence approach, two or three misses at the fence.

40-59: Breaking to a trot while on course, counter-canter or cross-canter at ends of arena, missed lead changes, loss of stirrup, dropping a rein, extra stride in combination.

10-39: Rider avoids elimination, one or two refusals, knock-downs, dangerous fences.

SHW649. The following will result in elimination:

three cumulative refusals

off course

SHW649.1 If elimination occurs during a ride-off, the competitor is placed last of all those chosen for the ride-off.

SHW650. Major faults include:

a refusal

loss of stirrup

trotting while on course when not part of a test

loss of reins

incorrect diagonal

Outside assistance will be penalized at the judge's discretion.

SHW655. LEVEL I JUMPING. The purpose of Level I jumping is to allow a horse to compete in a field with minimally accomplished horses of the same level of experience. The Level I jumping is a stepping-stone to the more advanced competition of Level 2 /Level 3. This class should be judged according to the purpose of its intent. Fence heights shall be three feet to three feet three inches.

SHW655.1 With the exception of eligibility requirements and heights for the jumps, the same rules apply in Level I jumping class as apply in jumping.

SHW655.2 Horses are eligible to compete so long if they have not, as of January 1 of the current show year:

SHW655.2.1 won 25 combined points or more in the fol-

lowing AQHA-approved classes: working hunter, equitation over fences or jumping (horse points from all levels in any division will count and are cumulative in determining eligibility); or

SHW655.2.2 won a combined \$1,000 or more in any equine organization or association in working hunter, equitation over fences or jumping events.

SHW655.2.3 Accuracy of eligibility is the responsibility of the owner or exhibitor.

SHW656. JUMPING. The jumper's task is to solely jump and his score is based entirely on his performance alone. Open jumping is offered only as an all-age class.

SHW657. Arena Arrangement: There will be a minimum of four obstacles. Horses are to make a minimum of eight jumps.

SHW657.1 A spread fence consisting of two or more elements will be mandatory.

SHW657.2 It is recommended the first obstacle be no more than minimum height.

Post and Rail (at least two)

Chicken Coop

Stone Wall

Triple Bar

Brush Jump

SHW657.3 Both a starting line at least 12 feet (3.6 meters) in front of the first obstacle, and a finish line at least 24 feet (7.3 meters) beyond the last obstacle must be indicated by markers (at least 12 feet (3.6 meters) apart) at each end of the lines. Horse must start and finish by passing between markers.

SHW657.4 Obstacles, except within combinations, should be located a minimum distance of 48 feet (14.6 meters) apart, size of arena permitting.

SHW657.5 Height of obstacles must be a minimum of three feet six inches and a maximum of four feet (122 cm) in first go-round, except in youth and amateur which is a minimum of three feet three inches (99 cm) and a maximum of three feet six inches (105 cm).

SHW658. Jumping is a scored and timed event. The time taken will be used to break all ties on horses with jumping faults and/or the combination of jumping and time faults. Time allowed may be used under the direction of show management, judge(s), and professional course designer. The time allowed to complete the course should be calculated from an actual measurement of the course's length (a minimum speed of 360 yards (327.6 meters per minute)). The length of the course must be announced or posted prior to the start of the class. The judge should assure that the course has in fact been properly measured and the time allowed calculated according to the speed. After the first competitor has completed their round, the time allowed and the competitor's time should be announced. The use of a time allowed is optional in the first round.

SHW658.1 The judge(s) may change the time allowed if they feel it is inaccurate, but only after consultation with the course designer. The time allowed may only be adjusted after the first competitor completes the round without a disobedience and not later than following the third competitor to complete the course without a disobedience.

SHW658.2 The time limit to complete the course is double the time allowed.

SHW658.3 A one-second time fault is charged for each second or fraction thereof by which the time allowed is exceeded. Time faults awarded in a final jump-off are penalized one fault for each commenced second over time allowed. Knockdown(s) occurring from a refusal will incur a four-second penalty. Any competitor whose time including penalty seconds exceeds the time limit is eliminated.

SHW659. Jump-offs will be held over the original course altered as follows:

SHW659.1 The sequence of obstacles may be in any order as long as the original direction is maintained, with the exception of vertical obstacles being able to be jumped in the opposite direction from the first round.

SHW659.2 The height and spread of at least 50 percent of the obstacles shall be increased not less than three inches (7.6 cm) and not more than six inches (15.2 cm) in height, and to a maximum spread of six feet (1.8 meters).

SHW659.3 Courses may be shortened after the first round that might include obstacles that might not have been used in the first round. However, the course may not be shortened to less than 50 percent of the original obstacles and must include at least one vertical and one spread jump.

SHW659.4 When a jump-off is required, the winner will be decided on time only if faults are equal. If two or more horses are disqualified in the timed jump-off and are tied for a point, they are not to be re-jumped, but should flip a coin to break the tie.

SHW659.5 Time shall begin from the instant the horse's chest reaches the starting line until it reaches the finish line. Time shall be stopped while a knocked down jump is being replaced, this is from the moment the rider gets his mount in a position to retake the jump until the proper authority signals that the jump has been replaced. It shall be the rider's responsibility to be ready to continue the course when the signal is given.

SHW660. Scoring. Jumpers are scored on a mathematical basis and penalty faults which include knockdowns, disobediences and faults.

SHW660.1 First disobedience anywhere on course - four faults.

SHW660.2 Second cumulative disobedience anywhere on course - four faults.

SHW660.3 In cases of broken equipment, the rider may either continue without penalty or stop and correct difficulty, in which case he /she will be penalized four faults.

SHW660.4 In case of loss of shoe, rider may continue without penalty or be eliminated.

SHW660.5 Knockdown. An obstacle is considered knocked down and four faults assessed, when a horse or rider, by contact:

SHW660.5.1 Lowers any part thereof which establishes the height of the obstacle or the height of any element of a spread obstacle even when the falling part is arrested in its fall by any portion of the obstacle; or

SHW660.5.2 Moves any part thereof which establishes the height of the obstacle so it rests on a different support from the one on which it was originally placed;

SHW660.5.3 Knocks down an obstacle, standard wing, automatic timing equipment or other designated markers on

start and finish lines.

SHW660.5.4 If an obstacle falls after the horse leaves the ring, it shall not be considered a knockdown.

SHW660.6 Disobediences.

SHW660.6.1 Refusal. When a horse stops in front of an obstacle (whether or not the obstacle is knocked down or altered), it is a refusal unless the horse then immediately jumps the obstacle without backing one step. If horse takes one step backwards, it is a refusal.

SHW660.6.1.1 After a refusal, if horse is moved toward the obstacle but does not attempt to jump, it is considered another refusal.

SHW660.6.1.2 In the case of a refusal on an in-and-out jump, the horse must return to the start of the in-and-out sequence and rejump previous elements as well as following elements.

SHW660.7 Run-out. A run-out occurs when the horse evades or passes the obstacle to be jumped; jumps an obstacle outside its limiting markers; or when the horse or rider knocks down a flag, standard, wing or other element limiting the obstacle (without obstacle being jumped).

SHW660.7.1 Loss of forward movement. Failure to maintain trot, canter or gallop after crossing starting line, except when it is a refusal, a run-out or when due to uncontrollable circumstances, such as when an obstacle is being reset.

SHW660.7.2 Unnecessary circling on course. Any form of circle or circles, whereby the horse crosses its original track between two consecutive obstacles anywhere on course, except to retake obstacle after refusal or run-out.

SHW660.8 Elimination.

Third cumulative disobedience anywhere on course.

Jumping an obstacle before it is reset, or without waiting for signal to proceed.

Starting before judges signal to proceed.

Failure to enter ring within one minute of being called.

Failure to cross the starting line within 45 seconds after an audible signal to proceed.

Jumping an obstacle before crossing start line unless said obstacle is designated as a practice obstacle, or after crossing the finish line, whether forming part of the course or not.

Off course.

Rider and/or horse leaving the arena before finishing the course (penalized at any time the horse is in the ring).

Excessive use of a whip, rope, crop, bat or reins anywhere on the horse.

SHW680. DRESSAGE. An AQHA-approved event. AQHA will recognize these levels of dressage competition starting with the Training Level, continuing through First Level, Second Level, Third Level, Fourth Level, FEI Prix St. George, FEI Intermediate I, FEI Intermediate II, and FEI Grand Prix. Dressage may also be offered at an AQHA-approved show or special event and must be judged by a licensed USEF/USDF judge.

SHW680.1 Freestyle is not recognized.

SHW680.2 Dressage will be offered and approved through USEF/USDF licensed competitions holding an AQHA-approved class.

SHW680.3 Show approval as well as horse and exhibitor eligibility requirements must be met.

SHW680.4 A one-time license fee of \$85 for the horse must be recorded with AQHA prior to the competition.

SHW681. POINTS. The percentage score will be converted into a point value. Points will be awarded in each division and recorded on horse's records. AQHA points can be earned starting at Training Level going through Grand Prix. The points are listed on the horse's record and count for awards such as Register of Merit, year-end high points and also count for Incentive Fund payout; however, Training Level is not eligible for Incentive Fund payout. AQHA recognizes high points (first through 10th) for open, amateur and youth divisions for each level.

SCORES				
Percentages	60-65	66-70	71-75	76+
POINT CONVERSION				
Training Level	1	2	3	4
First Level	1.5	3	4.5	6
Second Level	2	4	6	8
Third Level	2.5	5	7.5	10
Fourth Level	3	6	9	12
FEI	4	8	12	16

SHW700. BARREL RACING. Exhibitors race against the clock, following a course consisting of three barrels in a triangular “clover-leaf” pattern. Contestants must choose either the right or left barrel, circle it, and go to the next barrel, completing the course after circling the third barrel and running home. Barrel racing is a timed event.

SHW700.1 The contestant is allowed a running start. At a signal from the starter, the contestant will run to barrel number 1, pass to the left of it, and complete an approximately 360 degree turn around it; then go to barrel number 2, pass to the right of it, and complete a slightly more than 360 degree turn around it; then go to barrel number 3, pass to the right of it, and do another approximately 360 degree turn around it; then sprint to the finish line, passing between barrel number 1 and 2. This barrel course may also be run to the left. For example, the contestants will start to barrel number 2, turning to left around this barrel, then to barrel number 1, turning to the right, then to barrel number 3, turning again to the right, followed by the final sprint to the finish line.

SHW700.2 Knocking over a barrel carries a five-second penalty.

SHW700.3 Failure to follow the course shall cause disqualification.

SHW700.4 A contestant may touch the barrel with his or her hands in barrel racing.

SHW700.5 A whip may not exceed two feet in length excluding over and unders which must be attached to the saddle.

SHW700.6 If exhibitor shows in more than one barrel racing class and pays entry fees for each class, exhibitor may run once and carry over the time for all the classes (roll over times).

SHW700.7 It is recommended that drags be conducted before the start of a barrel race and after every seven head. Show management may drag more frequently.

SHW700.8 The judge must disqualify any contestant for excessive use of a whip, rope, crop, bat or reins anywhere on the horse.

SHW700.9 If a tie occurs where points are involved, placing will be worked off if all tied exhibitors agree to participate in a run-off; if not, a coin toss will be used to separate the ties. The horse declared the winner in the runoff must rerun the pattern within two seconds of its original time or the runoff must be held again. Pen-

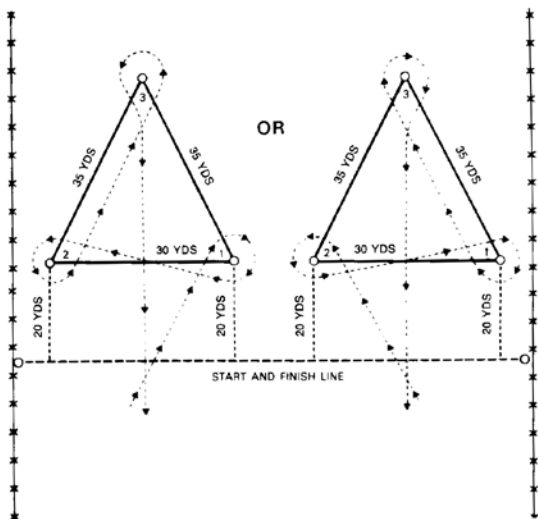

alty time will not apply to the two-second rule but will apply to the final runoff time.

SHW701. COURSE. The course must be measured exactly according to diagram and cannot exceed these dimensions. However, if the course is too large for the available space, the pattern should be reduced five yards at a time until the pattern fits the arena. Adequate space must remain between barrels and any obstacle. The distance from barrel number three to the finish line need not be reduced five yards (4.6 meters) at a time if there is sufficient room for the horse to stop.

SHW701.1 When measuring the area for the barrel course, allow ample room for horses to complete their turns and stop at the finish. It is recommended there be at least 45 feet (13.5 meters) from the starting line to the end of the arena, at least 18 feet (5.4 meters) from barrel number 1 and 2 to the fence and 36 feet (10.8 meters) from barrel number 3 to the end of the arena.

SHW701.2 Brightly colored 55 gallon (200 liters) steel drums with both ends in must be used.

SHW701.3 There shall be no rubber or plastic barrels or barrel pads used.

SHW702. Electronic timers are recommended to be used along with two back-up watches used by official timers. If electronic timer fails the average of the watches will be used to indicate the official time.

SHW702.1 Timing shall begin as soon as the horse's nose reaches the starting line and will be stopped when the horse's nose passes over the finish line.

SHW703. POLE BENDING. This timed event consists of a series of six poles spaced 21 feet apart, which horses and riders weave through at a high rate of speed. Horses run to the far end of the series of poles, turn and weave in and out as they work their way back to the front. Horses then complete a turn around the front pole and maneuver through the series again. At the last pole, they complete that turn and race toward the finish line at full speed.

SHW703.1 Each contestant will begin from a running start, and time shall begin and end as the horse's nose crosses the line. A clearly visible starting line must be provided. A horse may start either to the right or to the left of the first pole and then run the remainder of the pattern accordingly.

SHW703.2 Knocking over a pole shall carry a five-second penalty.

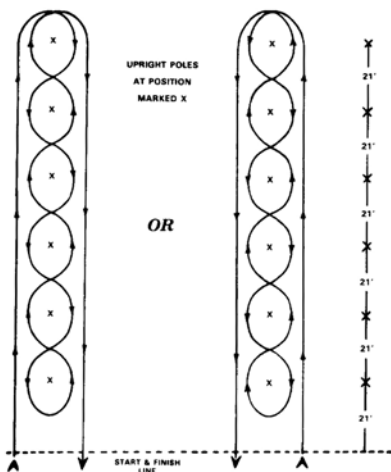

SHW703.3 Failure to follow the course shall cause disqualification.

SHW703.4 A contestant may touch a pole with his or her hand in pole bending. If the original course is altered by a rider intentionally grasping a pole, a five-second penalty for each pole grasped will be assessed.

SHW703.5 A whip may not exceed two feet in length excluding over and unders which must be attached to the saddle.

SHW703.6 If exhibitor shows in more than one pole bending class and pays entry fees for each class, exhibitor may run once and carry over the time for all the classes (roll over times).

SHW703.7 It is recommended that drags be conducted before the start of a pole bending and after every seven head. Show management may drag more frequently.

SHW703.8 The judge must disqualify any contestant for excessive use of a whip, rope, crop, bat or reins anywhere on the horse.

SHW703.9 If a tie occurs where points are involved, placing will be worked off if all tied exhibitors agree to participate in a run-off, if not, a coin toss will be used to separate the ties. The horse declared the winner in the runoff must rerun the pattern within two seconds of its original time or the runoff must be held again. Penalty time will not apply to the two-second rule, but will apply to the final runoff time.

SHW704. COURSE. Each pole is to be 21 feet (6.4 meters) apart, and the first pole is to be 21 feet (6.4 meters) from the starting line. Poles shall be set on top of the ground, six feet (1.8 meters) in height, with no base more than 14 inches (35 cm) in diameter.

SHW704.1 The pole bending pattern is to be run around six poles.

SHW705. Electric timers are recommended to be used along with two back-up watches used by official timers. If electronic timer fails, the average of the watches will be used to indicate the official time.

SHW710. STAKE RACE. An event for youth, amateur and Select exhibitors only, the stake race is a timed event consisting of markers set on either side of a center line. Contestants are given a running start to complete a figure 8 pattern. They must cross the center line between upright markers, head to either the right or left of the first pole, make a 180 degree turn, head to the second pole, turn around it in the opposite direction and then to the center line to stop the clock.

SHW710.1 The contestant is allowed a running start and may begin his run from either the left or right side of the first pole. Start by crossing the center line between the upright markers, turn

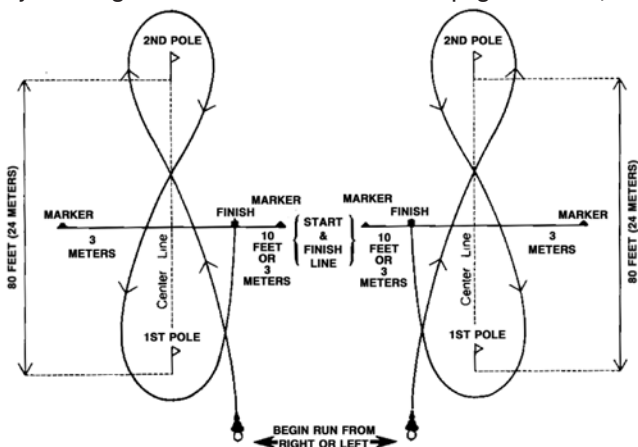

around the second pole, cross over the center line again between the markers, then around the first pole and run back across the finish line.

SHW710.2 If an upright marker or pole is knocked down, it shall result in no time. If the original course is altered by a rider intentionally grasping a pole, a five-second penalty for each pole grasped will be assessed.

SHW710.3 All horses must start from same end of arena.

SHW710.4 Failure to cross the start and finish line between the markers shall result in no time.

SHW710.5 Failure to cross over the center line between the markers before turning the second pole and cross back over the center line after turning the second pole, shall result in no time.

SHW710.6 A whip may not exceed two feet in length excluding over and unders which must be attached to the saddle.

SHW710.7 It is recommended that drags be conducted before the start of a stake race and after every seven head. Show management may drag more frequently.

SHW710.8 The judge must disqualify any contestant for excessive use of a whip, rope, crop, bat or reins anywhere on the horse.

SHW710.9 If a tie occurs where points are involved, placing will be worked off if all tied exhibitors agree to participate in a run-off; if not, a coin toss will be used to separate the ties.

SHW711. COURSE. The start and finish line is 20 feet (6 meters) wide and marked by two upright markers 10 feet (3 meters) on each side of the center line and short enough so as to not interfere with the timer if one is used. Short pylons or cones are recommended. The first and second poles marking the center line are each 40 feet (12 meters) from the start and finish line, making them a total of 80 feet (24 meters) apart.

SHW712. Electric timers are recommended to be used along with two back-up watches used by official timers. If electronic timer fails, the average of the watches will be used to indicate the official time.

SHW712.1 Timing shall begin as soon as the horse's nose reaches the starting line and will be stopped when the horse's nose passes over the finish line.

SHW750. COWBOY MOUNTED SHOOTING. As an AQHA-approved event, this is a fast-action, timed event over specific courses with a high degree of speed and agility from the horse and skilled shooting from the rider. Competitions will be held at existing Cowboy Mounted Shooting Association events.

SHW750.1 CMSA competition will be offered and approved through the Cowboy Mounted Shooting Association.

SHW750.1.1 Rules of the Cowboy Mounted Shooting Association are available at cowboymountedshooting.com

SHW750.2 AQHA horse and exhibitor eligibility requirements must be met.

SHW750.3 Approval privileges will be granted or denied by CMSA.

SHW750.4 POINTS. Points will be awarded in each division according to the existing point structure. Points and placing will be recorded on horses' and exhibitors' records. All points are eligible for existing AQHA awards.

SHW755 WALK/TROT CLASSES. Level I walk/trot classes can be held in western pleasure, western horsemanship, trail, hunter

under saddle and hunt seat equitation. Walk/trot classes are available, at the discretion of show management, at any approved show in Level I youth and Level I amateur classes.

SHW755.1 The Level I walk/trot classes can only be held as an all-age class and cannot be split out into youth age groups or select. Only one horse/rider combination is allowed per class. If a horse/rider combination was entered into a Level I walk/trot class that horse/rider combination could not show in the corresponding loping/cantering class at that show. However, that combination can switch back and forth between the different shows.

SHW755.2 There is no year-end high-point and is not a World Show class but points will be tracked and ROM and Superior certificates will be presented based on adding all of the points earned in the Level I walk/trot classes together. Incentive Fund money will not be awarded. Level I walk/trot points do not count for Performance Halter qualification.

SHW755.3 The same rules apply in Level I walk/trot classes as apply in the corresponding class, except loping/cantering is prohibited in both pattern and rail work.

SHW755.4 Faults:

- Exhibitors going off pattern, knocking over or on wrong side of cone, never performing specified gait, or overturning more than 1/4 turn than designated, shall not be disqualified, but must always place below exhibitors not incurring a disqualifying fault.
- Scored according to severity include:
 - Head carried too low and/or clearly behind the vertical excessively and consistently while the horse is in motion, or otherwise showing the appearance of intimidation.

SHW760. EQUESTRIANS WITH DISABILITIES (EWD) COMPETITION FOR INDEPENDENT & SUPPORTED EXHIBITORS.

SHW761. AWARDS AND RECOGNITION. Achievement points to be awarded in each class according to SHW261. Achievement points will be awarded to horse/exhibitor combination with the points being recorded on both the horse and exhibitor's individual AQHA records. A year-end high-point award will be available for the highest point earning exhibitor in the supported walk only division, independent walk/trot division and the independent walk/trot/lope division. Achievement points are not considered for World Show qualification or incentive fund eligibility.

SHW762. GENERAL RULES. To provide show management with the option to include equestrians with disabilities competition, AQHA has adopted these rules and provided an achievement points and awards system for participants. In doing so, AQHA does not assume responsibility for safety of participants. Since it is show management, which conducts these events and controls both the physical facility and all aspects of the events, responsibility for participant's safety remains solely with show management.

SHW762.1 Each participant or their parent or guardian by allowing participation, assumes all risk of personal injury or property damage occurring as a result of the participation and does hereby release and discharge the AQHA and show management, their respective officers, directors, representatives and employees from any and all liability, whenever or however arising, from such participation, except for the negligent act or omission, if any, of an indemnities. Further, as parent or legal guardian, they agree to indemnify

and hold harmless AQHA and show management from such liability to the minor.

SHW762.2 Attendance at a AQHA-approved event, in whatever capacity, shall constitute authorization for AQHA, its agents, designees, or assigns to photograph, video tape, televise, post to the web or record by other means (hereinafter referred to as “photographic material”) any person or animal on the premises of a AQHA approved event, and shall further constitute authorization for the use of such person’s name, voice and biography, or the name, pedigree and performance record of any animal on the premises (hereinafter referred to as “related information”) in conjunction with any photographic material.

SHW763. SHOW APPROVAL. Show management applies for AQHA-approval of these events on a voluntary basis and assumption of responsibility for safety by show management is required by AQHA as an express condition for AQHA to grant approval for these events.

SHW763.1 To obtain tentative AQHA-approval, application must be submitted a minimum of 120 days prior to the event on forms either provided by or acceptable to AQHA, stating the date and location of the desired events along with the show approval fee.

SHW763.2 The event will be approved if there is not an already known similar approved EWD event on the same date within a 300-mile radius.

SHW763.3 EWD classes may be held at AQHA-approved shows, US Para-Equestrian events or can be stand-alone events.

SHW763.4 An exhibitor may show more than one horse in individually worked classes as outlined in the rulebook, but horses cannot be shown by more than one exhibitor in the same EWD class.

SHW764. AQHA APPROVED EQUESTRIANS WITH DISABILITIES (EWD) CLASSES:

SHW764.1 Showmanship

Walk Only Showmanship

Walk-Trot-Jog Showmanship

SHW764.2 Supported Walk-Trot Division

Walk-Trot Hunt Seat Equitation on the Flat (supported)

Walk-Trot Hunter Under Saddle (supported)

Walk-Jog Trail (supported)

Walk-Jog Western Horsemanship (supported)

Walk-Jog Western Pleasure (supported)

SHW764.3 Independent Walk-Trot-Jog Category

Walk-Trot Hunt Seat Equitation on the Flat (independent)

Walk-Trot Hunter Under Saddle (independent)

Walk-Jog Para Reining (independent)

Walk-Jog Trail (independent)

Walk-Jog Western Horsemanship (independent)

Walk-Jog Western Pleasure (independent)

SHW764.4 Independent Walk-Trot/Jog-Canter/Lope Division

Walk-Trot-Canter Hunt Seat Equitation on the Flat (independent)

Walk-Trot-Canter Hunter Under Saddle (independent)

Walk-Jog-Lope Reining (independent)

Walk-Jog-Lope Western Horsemanship (independent)

Walk-Jog-Lope Western Pleasure (independent)

Walk-Jog-Lope Trail (independent)

SWH765. DIAGNOSIS. In order to be participate, an exhibitor must have a medically diagnosed condition that causes a permanent impairment that can be measured objectively. Examples of conditions, diseases or disorders that may lead to permanent impairment are: paresis, amputation (partial to full joint), ankylosis, upper motor neuron lesions, vision impairment, and intellectual disability. Eligible conditions include: amputation, arthrogryposis, Asperger syndrome, autism spectrum disorder, Batten disease, cerebrovascular accident (stroke), cerebellar ataxia, cerebral palsy, Coffin-Lowry syndrome, cystic fibrosis, Down syndrome, dwarfism, fragile X syndrome, Friedreich's ataxia, Guillain-Barre syndrome, hearing impairment, Hunter syndrome, juvenile rheumatoid arthritis, mental retardation, microcephaly, multiple sclerosis, muscular dystrophy, post-polio syndrome, Prader-Willi syndrome, Rett syndrome, spina bifida, spinal cord injury, Tourette syndrome, traumatic brain injury, trisomy disorders and visual impairment. Additional diagnosis will be considered upon request.

SHW765.1 Diagnosis Form and Acceptable Adaptive Equipment Form. In order to participation in EWD events, a licensed medical physician must sign an AQHA diagnosis form. Also an AQHA acceptable adaptive equipment form and riding ability form completed and signed by a certified instructor or coach of Professional Association of Therapeutic Horsemanship International (PATH Intl.), Special Olympics, US Para-Equestrian, Certified Horsemanship Association or IRD or a certified therapeutic riding instructor who is also a member in good standing of AQHA, indicating the riding ability and adaptive equipment that is required. A valid AQHA membership number or AQHA membership application must be submitted to AQHA. Upon receipt of the forms the AQHA membership card will be noted with EWD endorsement.

SHW765.2 Once and exhibitor competes in a walk, jog/trot ,lope/canter, they cannot return to walk, jog/trot classes at that same horse show.

SHW766. Exhibitor Age. Participants must be eight years of age and over to compete.

SHW767. Horse and exhibitor eligibility requirements must be met.

SHW767.1 Neither the exhibitor or their immediate family is required to own the horse. However the owner(s) must be AQHA members in order to compete.

SHW767.2 Stallions are not eligible to be shown in any AQHA EWD activities.

SHW767.3 The welfare of the horse is outlined in the rulebook, however, horses with a slight disability or lameness may be used at the discretion of the judge.

SHW767.4 Any breed of horse may be shown at the same event, and may be run concurrently. However in order to be eligible for AQHA year-end awards and notation of results on the horse's record the horse must be registered with the AQHA. Judges would only reflect the number of entries in the class, which are registered with the AQHA.

SHW768. GENERAL RULES FOR TACK AND EQUIPMENT. English and western equipment and attire will follow rules as set forth in the rulebook with the exception of EWD acceptable adaptation equipment.

SHW768.1 Helmet. Exhibitors must wear a properly fitted and fastened with harness, ASTM approved protective helmet. A west-

ern hat may be affixed over the helmet in western events. Equipment should conform to the riding ability of the competitor and be suitable for the horse.

SHW768.2 Halter. All horses when ridden must wear a halter in a manner that does not interfere with reining of the horse. A halter must be on the horse either over or under the bridle for use by the handler if needed. All exhibitors should be able to hold reins.

SHW768.3 Bits or bosal. A snaffle bit, curb bit or bosal/hackamore may be used no matter the age of the horse.

SHW768.4 Exhibitors are allowed to ride with one or two hands at any time during the class.

SHW768.5 Exhibitors are allowed to hold the saddle with either hand without penalty.

SHW768.6 EWD Acceptable adaptive equipment includes but not limited to:

SHW769. HANDLER. Required for all independent exhibitor classes: one handler per entry to facilitate the safety of the exhibitor. The handler must be 16 years of age or older. The handler must have a lead line without a chain in their hand in case of safety issues.

SHW769.1 Handlers shall stand quietly in a designated area, not obscuring the judge's line of vision, unless their assistance is required and requested by the judge or ring steward in the event of a safety issue. The handler may either take a position behind, beside or in front their respective exhibitor's horse or quietly walk forward and snap onto the horse's halter after the exhibitor's pattern is completed or the class has come in to line up.

SHW769.2 A blind or deaf exhibitor may have an assistant who communicates via verbal or sign language or cue cards to the competitor so they may hear the judge's directives or pattern instructions. This assistant will be outside the ring and their position known to the judge and ring steward.

SHW769.3 LEADERS AND SIDEWALKERS The supported exhibitor must have a leader with a loose lead without a chain, attached to the halter in a manner that does not interfere with reining of the horse. The supported exhibitor may need the assistance of one or two side walkers. Once the class has started, unauthorized assistance from horse leaders, spotters and side walkers will result in penalties. Side walkers may not give verbal commands or extra physical prompting, except in case of emergency.

SHW769.4 Handlers, leaders, side walkers, or extra spotters other than the required horse handler are not considered tack or equipment.

SHW770. ARENA SET UP. Markers must be used and may be numbered or lettered. People shall not be used as markers.

SHW771. PATTERNS All patterns must be posted one hour before the class. One of the suggested EWD patterns(s) must be used, however a judge in concert with the show management may utilize a different pattern in the walk-trot showmanship at halter, walk-trot-canter hunt seat equitation, walk-jog-lope western horsemanship, trail and para-reining using the acceptable maneuvers.

SHW772. Classes may be split at the discretion of show management. If a go rounds are necessary, in the interest of successful implementation of the approved show, the number of go-rounds to be held and the number of horses to be shown at each go round should be based on safety and/or physical constraints of show premises when

applied fairly and uniformly by a procedure in which all qualified entries are included in a random draw. When necessary to split large classes by running more than one go-round, finalists must rework the specified class requirements EXCEPT any scored class.

SHW773. Judging Equestrians with Disabilities Supported Exhibitor. Classes shall follow these guidelines, reversing only at the walk and omitting all extended gaits. Horses should be backed in the line-up, not on the rail. Horses should be worked for the amount of time necessary to evaluate each gait in each direction, taking into account the stress on the exhibitor and/or leader-side-walkers. The judge could choose to have the horse(s) walk briefly before resuming the jog/trot and completing the judging. The horses in the EWD supported classes are judged doing their jobs in spite of the challenges that may be presented due to the type of support or adaptive equipment that is required. Neither the amount of support and type of EWD acceptable adaptive equipment nor the unique characteristics of a specific exhibitor's disability should enter into the judging criteria.

SHW774. EWD SHOWMANSHIP AT HALTER – Walk Only, Walk-Trot/Jog, Walk-Trot/Jog. EWD exhibitors may show in only one showmanship class.

SHW774.1 Equipment and attire. Class can be shown English or western attire but must be one way or the other. There will be no mixing of attire or equipment on a horse/exhibitor. It is recommended to use a plain leather halter and plain lead for English attire. A plain leather halter or sterling silver mounted leather halter with leather lead is recommended for western attire. The use of a chain is permitted but discouraged. No bridles and/or bits and/or lip chains may be used.

SHW774.2 Refer to the **SHW370** for rules on exhibiting and how the class is judged.

SHW774.3 Class Procedure. All exhibitors may enter the ring and then work individually or each exhibitor may be worked from the gate individually.

SHW774.4 Individual Workout. The judge may select an appropriate EWD pattern. In the event that the judge in concert with the show management develops a walk-trot/jog showmanship at halter pattern instead of using existing EWD pattern(s) maneuvers found in SHW370 are acceptable, however the following are unacceptable: back in a curved line, pull turns. No exhibitor will be disqualified except for safety reasons at the judge's discretion. Exhibitors going off pattern will be penalized and placed at the bottom of the class.

SHW774.5 Scoring. Exhibitors are to be scored from 0 to 100, in 1/2 point increments.

SHW775. EWD WALK & TROT HUNT SEAT EQUITATION ON THE FLAT – Independent or Supported

SHW775.1 Refer to the **SHW616** for rules on attire, exhibiting and how the class is judged.

SHW775.2 Class Procedure. All exhibitors must enter the ring and then work individually, or each exhibitor may be worked from the gate individually. When exhibitors are worked individually from the gate, a working order is required. Exhibitors should be instructed to either leave the arena, fall into line, or fall into place on the rail after their individual work. The whole class, or just the finalists, must work at the appropriate gaits at least one direction of the arena.

SHW775.3 Individual Workout. The judge must select an appropriate EWD pattern.

SHW775.4 Scoring. Exhibitors are to be scored from 0 to 100, in 1/2 point increments.

SHW776. EWD WALK, TROT, CANTER, HUNT SEAT EQUITATION ON THE FLAT – Independent

SHW776.1 Refer to the **SHW645** for rules on attire, exhibiting and how the class is judged.

SHW776.2 Class Procedure. All exhibitors must enter the ring and then work individually, or each exhibitor may be worked from the gate individually. When exhibitors are worked individually from the gate, a working order is required. Exhibitors should be instructed to either leave the arena, fall into line, or fall into place on the rail after their individual work. The whole class, or just the finalists, must work at the appropriate gaits at least one direction of the arena.

SHW776.3 Individual Workout. The judge may select an appropriate EWD pattern. In the event that the judge in concert with the show management develops a walk-trot-canter hunt seat equitation pattern instead of using existing EWD pattern(s) maneuvers found in SHW645 are acceptable however the following are unacceptable: mount or dismount or drop or pick-up Irons without stopping, address reins, hand gallop, or counter-canter.

SHW776.4 Scoring. Exhibitors are to be scored from 0 to 100, in 1/2 point increments.

SHW777. EWD WALK & TROT HUNTER UNDER SADDLE – Independent or Supported

SHW777.1 Refer to **SHW601** for rules on attire, exhibiting and how the class is judged.

SHW777.2 Class Procedure. Exhibitors will compete on the rail at a walk and trot both ways of the ring, line up. No extended gaits. Exhibitors will back in the line up not the rail.

SHW778. EWD WALK & TROT & CANTER HUNTER UNDER SADDLE – Independent.

SHW778.1 Refer to SHW601 for rules on attire, exhibiting and how the class is judged.

SHW778.2 Class Procedure. Exhibitors will compete on the rail at a walk, trot and canter both ways of the ring, line up. No extended gaits. Exhibitors will back in the line up not the rail.

SHW779. EWD WALK & JOG WESTERN HORSEMANSHIP – Independent or Supported

SHW779.1 Refer to **SHW430** for rules on attire, exhibiting and how the class is judged.

SHW779.2 Class Procedure. All exhibitors must enter the ring and then work individually, or each exhibitor may be worked from the gate individually. When exhibitors are worked individually from the gate, a working order is required. Exhibitors should be instructed to either leave the arena, fall into line, or fall into place on the rail after their individual work. The whole class, or just the finalists, must work at the appropriate gaits at least one direction of the arena.

SHW779.3 Individual Workout. The judge must select an appropriate EWD pattern.

SHW779.4 Scoring. Exhibitors are to be scored from 0 to 100, in 1/2 point increments.

SHW780. EWD WALK, JOG AND LOPE WESTERN HORSEMANSHIP – Independent.

SHW780.1 Refer to **SHW430** for rules on attire, exhibiting and how the class is judged.

SHW780.2 Class Procedure. All exhibitors must enter the ring and then work individually, or each exhibitor may be worked from the gate individually. When exhibitors are worked individually from the gate, a working order is required. Exhibitors should be instructed to either leave the arena, fall into line, or fall into place on the rail after their individual work. The whole class, or just the finalists, must work at the appropriate gaits at least one direction of the arena.

SHW780.3 Individual Workout. The judge may select an appropriate EWD pattern. In the event that the judge in concert with the show management develops a walk-Jog-lope western horsemanship pattern instead of using existing EWD pattern(s) maneuvers found SHW430 are acceptable however the following are unacceptable: mount or dismount or ride without stirrups, back in a curved line, spins, rollbacks on the haunches and/or on the forehand;

SHW780.4 Scoring. Exhibitors are to be scored from 0 to 100, in 1/2 point increments.

SHW781. EWD WALK & JOG WESTERN PLEASURE – Independent or Supported.

SHW781.1 Refer to **SHW402** for rules on attire, exhibiting and how the class is judged.

SHW781.2 Class Procedure. Exhibitor will compete on the rail at a walk and jog both ways of the ring, line up. No extended gaits. Exhibitors will back in the line up not the rail.

SHW782. EWD WALK & JOG & LOPE WESTERN PLEASURE – Independent.

SHW782.1 Refer to SHW402 for rules on exhibiting and how the class is judged.

SHW782.2 Class Procedure. Exhibitor will compete on the rail at a walk, jog and lope both ways of the ring, line up. No extended gaits. Exhibitors will back in the line up not the rail.

SHW783. EWD WALK, JOG/TROT TRAIL HORSE CLASS – Independent or Supported.

SHW783.1 Equipment and attire. Class can be shown English or western attire but must be one way or the other. There will be no mixing of attire or equipment on a horse/exhibitor.

SHW783.2 Refer to **SHW461** for rules on exhibiting and how the class is judged.

SHW783.3 Class procedure. This class will be judged on the performance of the horse and while maneuvering a minimum of 5 obstacles for walk, trot/jog trail. Exhibitors are to work individually. There will be no rail work.

SHW783.4 Course. Refer to SHW461 for acceptable and unacceptable obstacles. Safety should be the first consideration in designing and setting up the course. All obstacles found in SHW461 are acceptable however the following are unacceptable: carrying an object, water hazard, slicker, mailbox.

SHW783.5 Scoring. Scoring will be on the basis of 0-100, with 70 denoting an average performance. Each maneuver will be scored from a plus 1 1/2 to a minus 1 1/2, in 1/2 point increments. An obstacle

missed, refused or taken out of order will result in a score of zero for that obstacle but will not disqualify entry.

SHW784. EWD WALK, JOG/TROT, LOPE TRAIL HORSE CLASS – Independent

SHW784.1 Equipment and attire - Class can be shown English or western attire but must be one way or the other. There will be no mixing of attire or equipment on a horse/exhibitor. Refer to **SHW461** for rules on exhibiting and how the class is judged.

SHW784.2 Class procedures. This class will be judged on the performance of the horse and while maneuvering minimum of 6 obstacles for walk, trot/jog, canter/lope trail. Exhibitors are to work individually. There will be no rail work.

SHW784.3 Course. Refer to SHW461 for acceptable and unacceptable obstacles. Safety should be the first consideration in designing and setting up the course. All maneuvers found in SHW461 are acceptable however the following are unacceptable: carrying an object, water hazard, slicker, mailbox.

SHW784.4 Scoring. Scoring will be on the basis of 0-100, with 70 denoting an average performance. Each maneuver will be scored from a plus 1 1/2 to a minus 1 1/2, in 1/2 point increments. An obstacle missed, refused or taken out of order will result in a score of zero for that obstacle but will not disqualify entry.

SHW785. EWD WALK & JOG REINING - Independent.

SHW795.1 Refer to SHW480 for rules on exhibiting and how the class is judged.

SHW785.2 This class is to be run with a walk in patterns only.

SHW785.3 Scoring. Scoring will be on the basis of 0-100, with 70 denoting an average performance. Each maneuver will be scored from a plus 1 1/2 to a minus 1 1/2, in 1/2 point increments.

SHW786. WALK & JOG & LOPE REINING - Independent.

SHW786.1 Refer to **SHW480** for rules on attire, exhibiting and how the class is judged. This class is to be run with a walk in patterns only.

SHW786.2 Scoring. Scoring will be on the basis of 0-100, with 70 denoting an average performance. Each maneuver will be scored from a plus 1 1/2 to a minus 1 1/2, in 1/2 point increments.

SHW787. The following are allowance made for all EWD Para Reining classes only:

SHW787.1 Exhibitors are allowed to choose the size and speed of the circles. Excessive speed will result in a maneuver deduction.

SHW787.2 Lead Changes. Simple lead changes are allowed and the ideal change is to jog for one stride to change leads. Any deviation from the ideal change that takes place in the lead change area as described by the rulebook would not incur a penalty but deserves less credit. In order of decreasing difficulty would be jogging more than one stride, walking rather than jogging, stopping during the change and finally more than one attempt to execute the change. Penalties would apply if the lead change was early or late just as they would for a flying lead change.

SHW787.3 Judges should allow one-quarter circle coming into the change and one-quarter circle going past the change as an allowable simple change area (safe zone), with only the out of lead penalties applying. For example, a horse that comes across and takes 3 strides past "center" to complete the simple change, but before the end of the first quarter, would not get a break of gait

EQUESTRIANS WITH DISABILITIES SHOWMANSHIP (WALK ONLY)

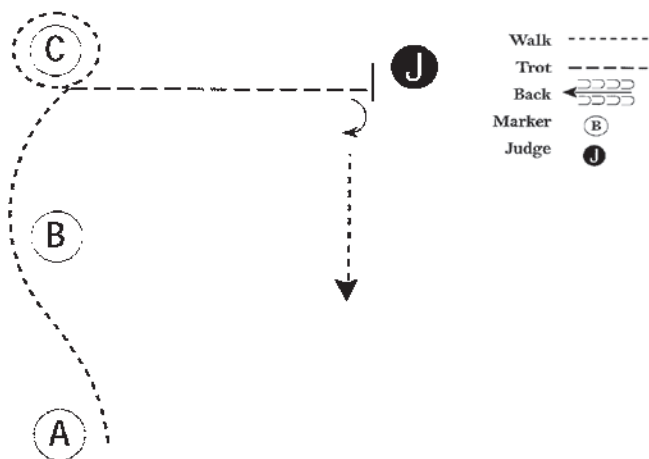

Be ready at A.

1. When acknowledged, walk from A, around B to C.
2. Walk a tight circle around C.
3. Walk to judge.
4. Stop and set up for inspection.
5. When dismissed, perform a 90 degree turn and walk away from judge. Follow the directions of your ring steward.

EQUESTRIANS WITH DISABILITIES SHOWMANSHIP (WALK-TROT)

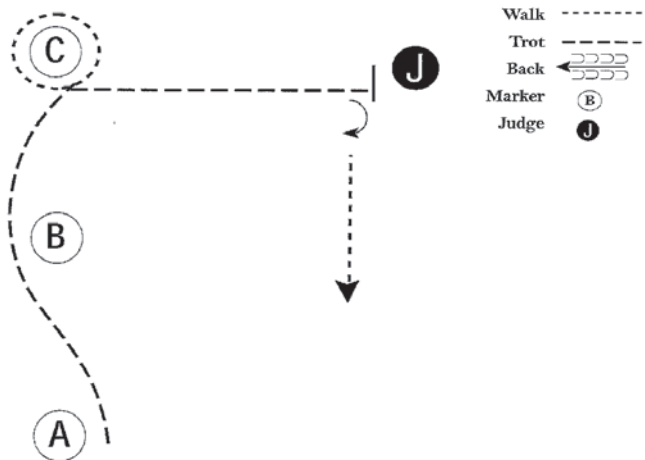

Be ready at A.

1. When acknowledged, trot from A, around B to C.
2. Walk a tight circle around C.
3. Trot to judge.
4. Stop and set up for inspection.
5. When dismissed, perform a 90 degree turn and walk away from judge. Follow the directions of your steward.

EQUESTRIANS WITH DISABILITIES WESTERN HORSEMANSHIP (WALK-JOG)

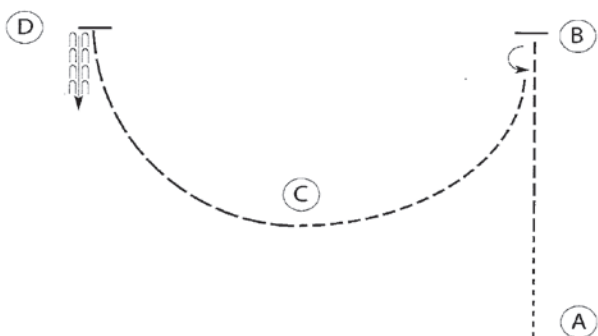

Be ready at A.

1. Walk approximately two strides from A.
 2. Jog to B.
 3. Stop and perform a 180 degree turn to the left.
 4. Jog a half circle to C.
 5. Extend the jog to D.
 6. Stop at D and back approximately one horse length.
- Follow the instructions of your ring steward.

Walk	-----
Jog	- - - - -
Extended Jog	- - - - -
Lope	=====
Leg Yield	
Lead Change	
Back	←←←←←
Marker	←←←←←
Sidepass	←←←←←

EQUESTRIANS WITH DISABILITIES WESTERN HORSEMANSHIP (WALK-JOG-LOPE)

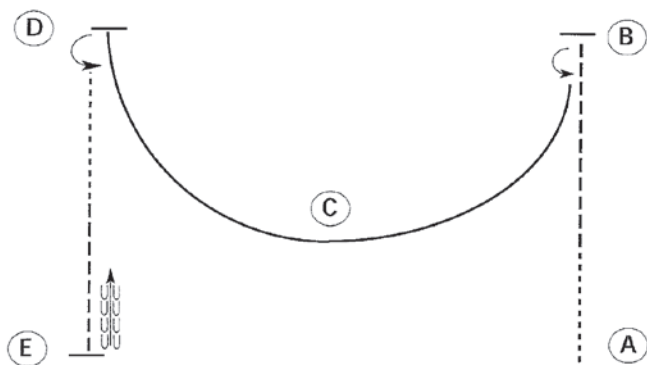

Be ready at A.

1. Walk approximately two strides from A.
 2. Jog at B.
 3. Stop and perform a 180 degree turn to the left.
 4. Lope on the right lead around C and to D.
 5. Stop and perform a 180 degree turn to the left.
 6. Walk halfway to E.
 7. Jog to E, stop and back approximately one horse length.
- Follow the instructions of your ring steward.

EQUESTRIANS WITH DISABILITIES HUNT SEAT EQUITATION (WALK-TROT)

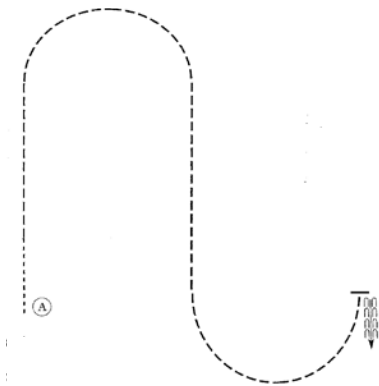

Walk	-----
Trot	- - - - -
Extended Trot	—————
Canter	—————
Leg Yield	
Lead Change	—/—
Back	←←←←←
Marker	⊙ B
Sidepass	←←←←←
Hand Gallop	—————

Be ready at A.

1. Walk two horse lengths from A.
 2. Trot forward and a half circle on the left diagonal until even with B.
 3. Change diagonal and trot straight and then a half circle on the right diagonal until even with A.
 4. Stop and back approximately one horse length.
- Follow the instructions of your ring steward.

EQUESTRIANS WITH DISABILITIES HUNT SEAT EQUITATION (WALK TROT CANTER)

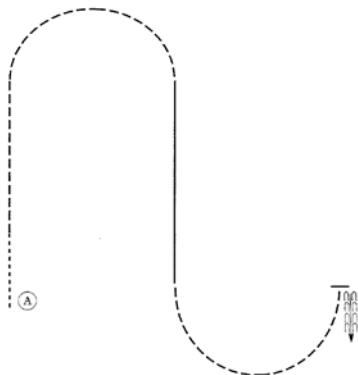

Walk	-----
Trot	- - - - -
Extended Trot	—————
Canter	—————
Leg Yield	
Lead Change	—/—
Back	←←←←←
Marker	⊙ B
Sidepass	←←←←←
Hand Gallop	—————

Be ready at A.

1. Walk two horse lengths from A.
 2. Trot forward on the left diagonal and a half circle until even with B.
 3. Canter on the left lead until even with A.
 4. Trot a half circle on the right diagonal until even with A.
 5. Stop and back approximately one horse length.
- Follow the instructions of your ring steward.

EQUESTRIANS WITH DISABILITIES TRAIL DIAGRAM AND DISTANCES

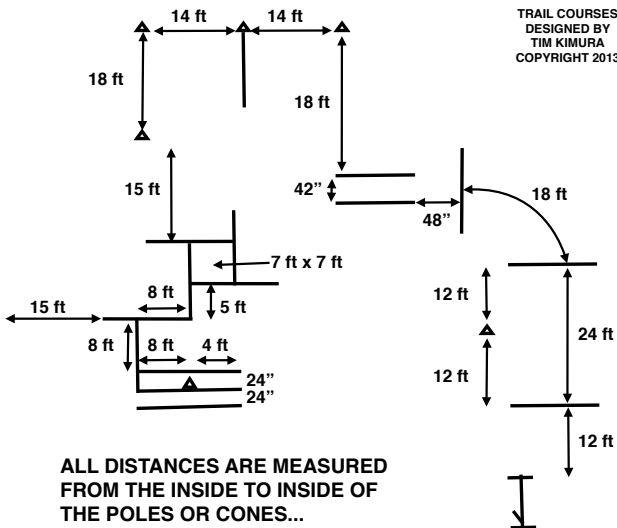

EQUESTRIANS WITH DISABILITIES TRAIL WALK-JOG

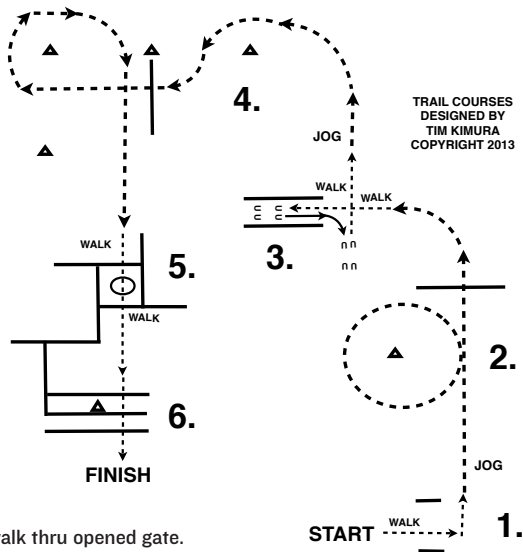

1. Gate walk thru opened gate.
2. Jog circle around cone jog over pole.
3. Stop or break to walk, walk into chute back thru poles turn and walk forward.
4. Jog around cones
5. Stop or break to walk, walk into box, execute a 360 turn either way, walk out.
6. Walk over poles.

EQUESTRIANS WITH DISABILITIES TRAIL WALK-JOG OR WALK-JOG-LOPE

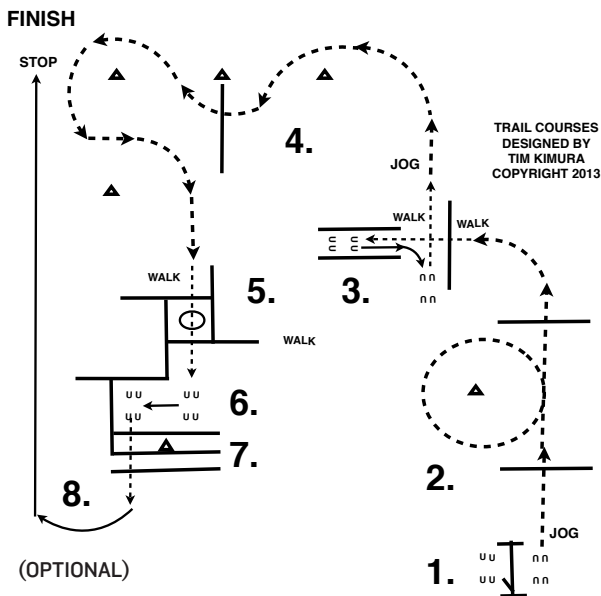

1. Gate left hand ride thru close.
2. Jog over poles, jog circle around cone.
3. Stop or break to walk, walk over pole and into chute, back around corner, walk out.
4. Jog thru serpentine, jog around cones.
5. Stop or break to walk, walk into box, execute a 360 turn either way, walk out.
6. Side pass right between poles.
7. Walk over poles.
8. Lope right lead and stop at cone.

PARA-REINING

WALK, JOG, PARA-REINING #1

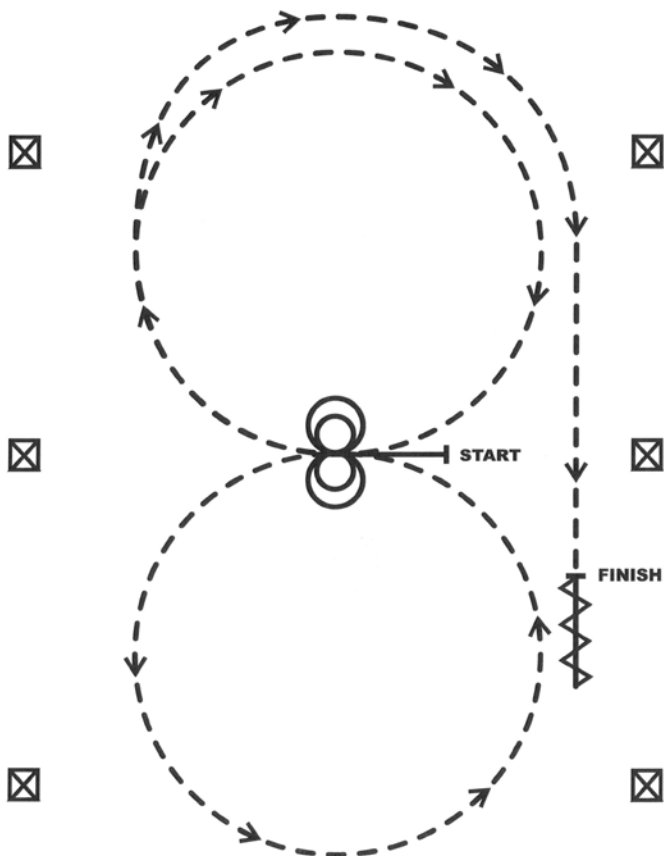

Horses may walk or trot to the center of the arena. Horses must walk or stop prior to starting the pattern. Beginning at the center of the arena facing the left wall or fence.

1. Complete two spins to the left. Hesitate.
2. Complete two spins to the right. Hesitate
3. Trot once circle to the right, change directions at the center of the arena.
4. Complete one circle to the left, change directions at the center of the arena.
5. Begin a circle to the right but do not close this circle. Trot straight down the right side of the arena past the center marker, stop and back up at least 10 feet. Hesitate to demonstrate completion of the pattern.

PARA-REINING #1

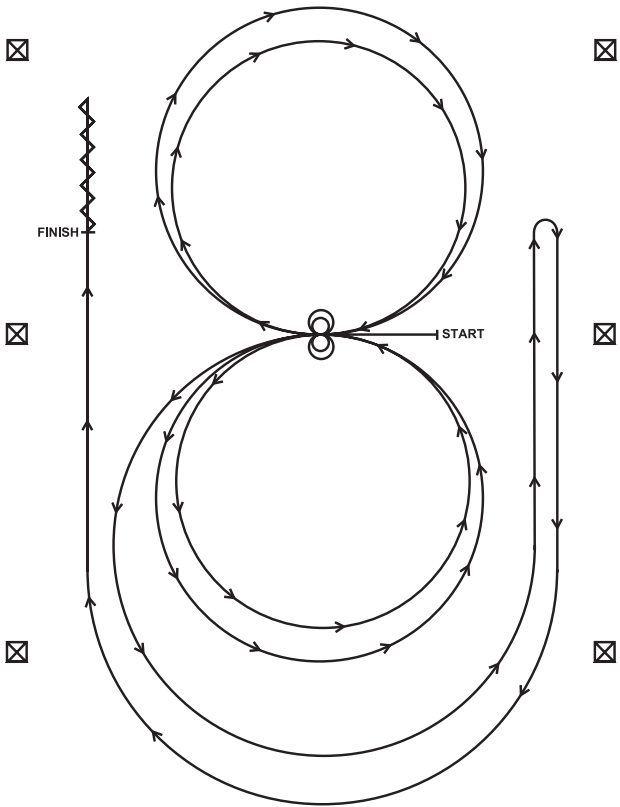

Horses may walk or trot to the center of the arena. Horses must walk or stop prior to starting the pattern. Beginning at the center of the arena facing the left wall or fence.

1. Beginning on the left lead, complete two circles to the left. Stop at the center of the arena. Hesitate.
2. Complete two spins to the left. Hesitate.
3. Beginning on the right lead complete two circles to the right. Stop at the center of the arena. Hesitate.
4. Complete two spins to the right. Hesitate.
5. Beginning on the left lead, go around the end of the arena, run down the right side of the arena past center marker, stop and roll back right.
6. Continue around the end of the arena to run down the left side of the arena past the center marker. Stop. Back up.

Hesitate to show completion of pattern.

PARA-REINING #2

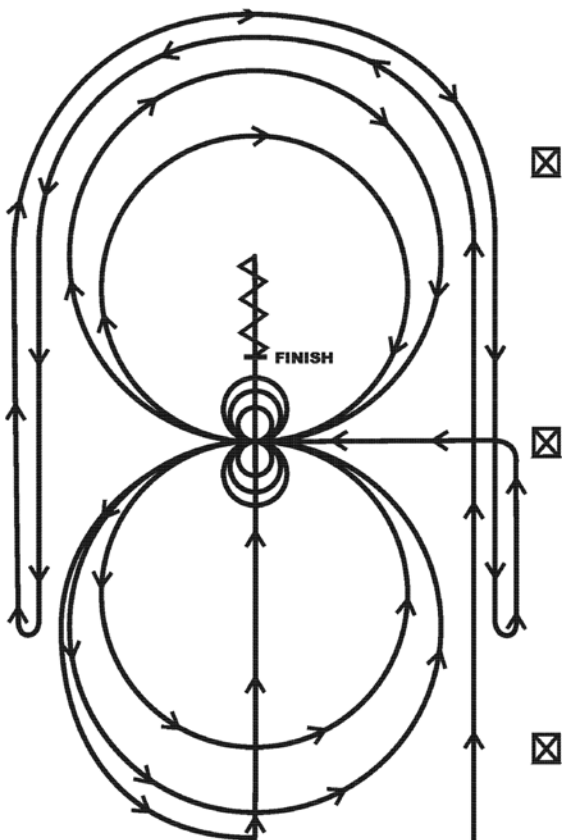

1. Run around the end of the arena, run down the left side past center marker, right rollback
2. Run around end of arena, run down right side past center marker, left rollback
3. Left circles, one large fast and one small slow, stop at center
4. 3 spins left, hesitate
5. Right circles, one large fast and one small slow, stop at center
6. 3 spins right, hesitate
7. Begin large fast circle to left at the top of the circle, run down the center of arena past center marker, stop.
8. Back up at least 10 feet, hesitate.

Hesitate to show completion of pattern.

PARA-REINING #3

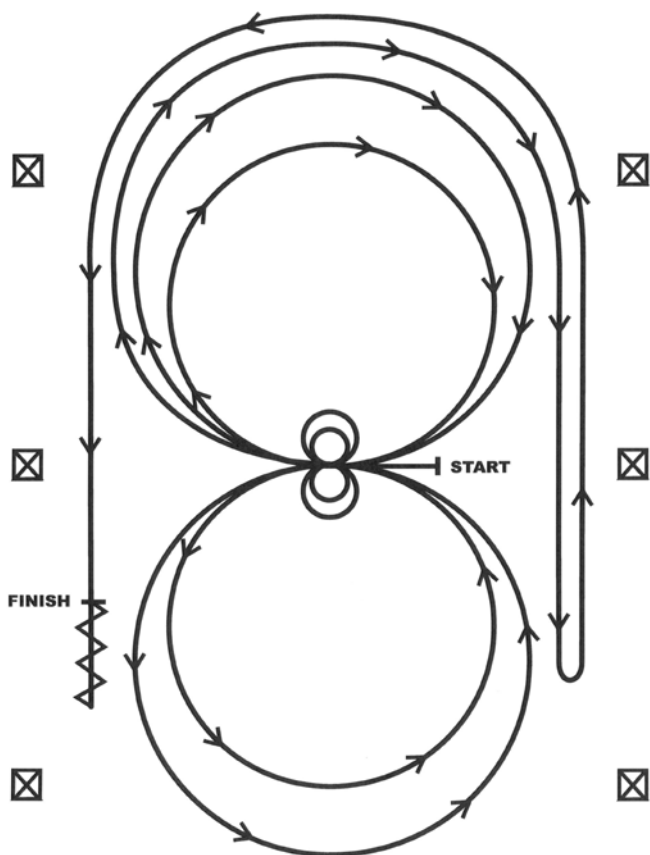

Horses may walk or trot to the center of the arena. Horses must walk or stop prior to starting the pattern. Beginning at the center of the arena facing the left wall or fence.

1. Complete two spins to the left. Hesitate.
2. Complete two spins to the right. Hesitate.
3. Beginning on the right lead, complete two circles to the right, the first circle small and slow and the second circle large and fast. At the center of the arena, do a simple lead change.
4. Complete two circles to the left, the first circle small and slow and the second circle large and fast. At the center of the arena, do a simple lead change.
5. Begin a circle to the right but do not close this circle. Lope down the right side of the arena past the center marker and stop and do a right rollback.
6. Lope back around the previous circle but do not close this circle. Lope down the right side of the arena past the center marker, stop and back at least ten feet. Hesitate to demonstrate completion of the pattern.

penalty but would incur a one point out of lead penalty. The same logic would apply for changes before reaching center. All penalty applications would apply out of that “safe zone.”

SHW787.4 Break of gait; Note: Simple lead changes are allowed therefore, no break of gait penalty should be applied during the lead change. EWD classes may use altered patterns and if simple lead changes are specified, no break of gait penalty should be applied during the lead changes.

SHW790. INTERNATIONAL PERFORMANCE EVENTS.

SHW790.1 All international performance events can be held as a special event or can be utilized as a performance event for show approval and will receive recognition for year-end awards.

SHW790.2 Exhibitor eligibility must be met, and horses must be registered American Quarter Horses to be eligible for year-end awards.

SHW791. Cala (Mexican-style reining) and Colas (tailing of the bull). Events held in Mexico with rules provided by the Association Mexicana de Criadores de Caballos Cuarto de Milla, as approved by AQHA.

SHW791.1 Judged by persons approved by the Association even though such judges are not also on the list of judges approved by AQHA.

SHW791.2 Any other approved AQHA event held in conjunction with Cala or Colas must be judged by an AQHA approved judge.

SHW792. Campdrafting. Events held in Australia with rules provided by the Australian Quarter Horse Association, as approved by the American Quarter Horse Association.

SHW792.1 Judged by persons approved by the Australian Quarter Horse Association, even though such judges are not also on the list of judges approved by the American Quarter Horse Association.

SHW792.2 Any other approved AQHA event held in conjunction with Camp-drafting must be judged by an AQHA approved judge.

SHW793. Vaquejada (tailing of the bull) and Lazo Comprido (similar to heading). Events held in South America with rules provided by the recognized international affiliate, as approved by AQHA.

SHW793.1 Judged by persons approved by the International Affiliate even though such judges are not also on the list of judges approved by AQHA.

SHW793.2 Any other approved AQHA event held in conjunction with Vaquejada and/or Lazo Comprido must be judged by an AQHA approved judge.

SHW794. Lazo de Panama (roping event). Events held in Panama with rules provided by the recognized international affiliate, as approved by AQHA.

SHW984.1 Judged by persons approved by the International Affiliate even though such judges are not also on the list of judges approved by AQHA.

SHW794.2 Any other approved AQHA event held in conjunction with Lazo de Panama must be judged by an AQHA approved judge.

METRIC SYSTEM

Unit	Abbreviation	Number of Meters	Approximate U.S. Equivalent
kilometer (1 mile equals 1.6094 kilometers)	km	1,000	0.62 mile
meter (1 yard equals 0.9144 meter)	m	1	39.37 inches
centimeter (1 inch equals 2.54 centimeters)	cm	0.01	0.39 inch
millimeter	mm	0.001	0.04 inch

AWARDS

SHW800. GENERAL. Any horse declared ineligible from participation in AQHA-approved shows arising from violation of AQHA show rules is ineligible to receive any AQHA year-end award during that calendar year.

SHW801. GRAND CHAMPION - OPEN, AMATEUR, YOUTH - will be awarded in the open, amateur, and/or youth division to any horse earning the title of grand champion if there are five or more horses exhibited in the sex division. A trophy will be awarded to a horse the first time it earns a grand championship in each division - open, amateur and/or youth - under the current record ownership. If the horse subsequently earns another grand championship under the same ownership, the owner may purchase a similar trophy if the show does not award it.

SHW802. REGISTERS OF MERIT - OPEN, AMATEUR, YOUTH DIVISION - There are three Registers of Merit; racing, halter/performance halter, performance. Points earned in Rookie and Level I (exhibitor) classes do not apply toward registers of merit awards; however, points earned in Level I (horse) classes do apply toward a performance register of merit. A Register of Merit or "ROM" is awarded when a horse:

SHW802.1 Racing ROM: has received at least one official speed index rating of 80 or higher in racing. A racing ROM is based on speed index rating only and not racing points.

SHW802.2 Performance ROM: in the open division, or an amateur or youth with any one horse in their respective division, has won at least 10 points in one or more events (other than halter, performance halter and racing). No horse can be advertised as Register of Merit in any specific performance class without having won at least five points in that specific class. Level 1, level 2 and level 3 points count toward the performance ROM award.

SHW802.3 Halter/Performance Halter ROM: won at least 10 points in halter/performance halter classes.

SHW802.4 Youth and/or amateur register of merits do not qualify a horse for advancement.

SHW803. ALL-AROUND - OPEN, AMATEUR, SELECT AMATEUR, YOUTH - a trophy will be awarded in the open, amateur, select amateur classes and/or youth division to any horse earning the title of all-around the first time it earns the all-around title under the current record ownership. If that horse earns another all-around title in another division - open, amateur, select amateur classes and/or youth - the owner may purchase a similar trophy if the show does not award it. The trophy will be awarded to the highest scoring stallion (except in the youth division where stallions are prohibited unless otherwise allowed), mare or gelding in events in shows approved by AQHA. Once the first-time complimentary trophy has been awarded, AQHA will subsequently award specially designed certificates to any horse earning the title of all-around or reserve all-around each time the title is earned in each - open, amateur, Select amateur and/or youth classes. Points earned in Rookie and Level I do not count to this award.

SHW803.1 For the open division all-around trophy to be awarded, the show must meet the requirement of a minimum of five halter classes for stallions, five halter classes for mares, five halter classes for geldings and one performance class.

SHW803.2 For the youth division all-around trophy to be awarded, four approved youth performance events must be offered whether the

youth show is conducted separately or in conjunction with approved AQHA shows for exhibitors of all ages and/or amateur shows.

SHW803.3 For the amateur division all-around trophy to be awarded, for approved amateur performance events offered whether the amateur show is conducted separately or in conjunction with approved AQHA shows for exhibitors of all ages and/or youth shows.

SHW803.4 Only Select classes count for earning a Select all-around trophy. Should the Select class be combined with the amateur all-age class, the points earned by the Select will count toward their all-around eligibility as a Select.

SHW803.4.1 If a Select exhibitor exhibits in halter, ranch riding, team penning, ranch sorting or jumping, those classes will count even though they are not offered as a Select class.

SHW803.5 To be eligible for all-around honors, a horse in the open division, amateur in the amateur division, Select amateur in the Select amateur classes or youth in the youth division must compete in at least three AQHA-approved events in one division - open, amateur, Select amateur, or youth classes - in three or more categories.

Category I	Halter/Performance Halter
Category II	Reining Working Cow Horse Boxing*** Western Riding Ranch Riding Trail
Category III	Team Penning Ranch Sorting Barrel Racing Pole Bending Stake Race*** Cowboy Mounted Shooting
Category IV	Jumping Working Hunter Hunter Hack
Category V	Western Pleasure 2-Year-Old Western Pleasure* Hunter Under Saddle Pleasure Driving**
Category VI	Tie-down Roping Breakaway Roping*** Dally Team Roping-Heading Dally Team Roping-Heeling Cutting
****Category VII	Showmanship at Halter Western Horsemanship Hunt Seat Equitation Equitation Over Fences
Category IX	Versatility Ranch Horse VRH Ranch Trail VRH Ranch Cutting VRH Ranch Cow Work VRH Limited Ranch Cow Work VRH Ranch Conformation Stallions Mares Geldings

VRH Ranch Conformation (youth)

Mares

Geldings

* Open division only

** Open and amateur divisions only

*** Amateur and youth divisions only

SHW803.6 The winner of the all-around award is determined by adding points earned by each horse in the open division, or contestant/horse in amateur, Select amateur and youth in every approved class in which it placed in the top nine. The horse in the open division, or contestant/horse in amateur, Select amateur and youth, having competed in at least three of the approved events in three or more categories and earning the greatest number of points shall be awarded the all-around trophy.

SHW803.7 Level I nor boxing points count toward the all-around trophy.

SHW803.8 SCORING. Horses competing in performance in the open division, or contestants in the youth, amateur or select amateur classes, placing in the top nine will be given one credit for each horse or contestant placing below them, plus one credit not to exceed nine credits for first place. **EXAMPLE:** In a class of nine or more horses, the first-place horse receives nine credits, second place eight credits, and so on through ninth place. In halter competition, horses in the open division, or contestants in the youth or amateur division, placing in the top nine, in divisions of five or more entries, will be given one credit more toward the all-around than any other entry one year old or older up to a maximum of nine credits if selected as grand champion of its sex division. In divisions of three to four entries, the grand champion will receive 1/2 more credit than any other entry one year old or older up to a maximum of nine credits. Likewise, if applicable, the reserve champion will receive as many credits as any other entry one year old or older in its sex division except for grand champion.

SHW803.8.1 No credits are to be awarded to a disqualified horse or contestant regardless of the number in the class. However, when less than nine are placed, even though more than nine entered the class, credits will be awarded on the basis of the number exhibited in the class.

SHW803.9 TIES The horse in the open, amateur, youth or Select, will be declared the all-around which:

SHW803.9.1 Earned credits in the greatest number of events

SHW803.9.2 The horse or contestant winning over the greatest number of horses

SHW803.9.3 Earned the most credits in performance events.

SHW804. SUPERIOR ALL-AROUND OPEN, AMATEUR, YOUTH - will be awarded to any individual youth or amateur exhibitor/horse combination or any stallion, mare or gelding in the open division that has earned 50 or more all-around titles.

SHW805. ACHIEVEMENT AWARDS. Following are categories in the open, youth and amateur divisions, to qualify for Register of Merit, AQHA Versatility, AQHA Champion, AQHA Supreme Champion, AQHA Superior (Event) Horse, AQHA Performance Champion and Youth Supreme Performance Champion awards.

Category I

Halter

Category II	Performance Halter Reining Working Cow Horse Boxing ^{***} / ^{****} Ranch Riding Western Riding Level I Western Riding ^{*/****} Trail Level I Trail ^{*/****}
Category III	Team Penning Ranch Sorting Barrel Racing Pole Bending Stake Race ^{***} Cowboy Mounted Shooting
Category IV	Jumping Working Hunter Level I Working Hunter ^{*/****} Hunter Hack Level I Jumping ^{*/****}
Category V	Western Pleasure Level I Western Pleasure ^{*/****} 2-Year-Old Western Pleasure ^{*/****} Hunter Under Saddle Level I Hunter Under Saddle ^{*/****} Pleasure Driving ^{**}
Category VI	Tie-down Roping Dally Team Roping-Heading Dally Team Roping-Heeling Breakaway Roping ^{***} Cutting and recognized Open NCHA Cutting Contests
^{***} Category VII	Showmanship At Halter Western Horsemanship Hunt Seat Equitation Equitation Over Fences
Category VIII	Racing ^{*****}
Category IX	Versatility Ranch Horse Division VRH Ranch Riding VRH Ranch Trail VRH Ranch Cutting VRH Ranch Cow Work VRH Limited Ranch Cow Work VRH Ranch Conformation Stallions Mares Geldings VRH Ranch Conformation (youth) Mares Geldings
Category X	Dressage
Category XI	Equestrians With Disabilities

* Open division only

** Open and Amateur divisions only

*** Amateur and Youth divisions only

**** Register of Merit only

*****Register of Merit based on Speed Index only – not points.

SHW806. VERSATILITY AWARD - OPEN, AMATEUR, YOUTH - will be awarded to any stallion, mare or gelding in the open division, an amateur or youth with any one horse in their respective division that has earned 65 points in eight events with a minimum of 10 points earned in each of five separate events and five points earned in each of three additional events.

SHW806.1 Halter/performance halter Rookie, and Level I points do not count toward the versatility award.

SHW807. AQHA CHAMPION - OPEN, AMATEUR, YOUTH - will be awarded in the open division to any stallion, mare or gelding, or in the amateur and youth division to the contestant and his/her horse in their respective division that earns a total of 35 or more points in AQHA-approved competition or races (for open division AQHA champions only), providing that:

SHW807.1 Points have been won in five or more shows and under five or more different judges.

SHW807.2 A minimum of 15 of these points have been earned in halter/performance halter classes, with a minimum of eight points being earned during or after the horse's 2-year-old year. In open division only, at least two grand championships with five or more horses in the sex division must have been earned under two different judges with at least one of them being earned on or after the horse's 2-year-old year and/or two performance halter champions, with five or more in the class.

SHW807.3 A minimum of 15 of these points must be earned in performance events with a minimum of five points having been earned in each of at least two categories of performance events.

SHW807.4 Rookie and Level I points do not count toward this award.

SHW808. SUPREME CHAMPION - OPEN DIVISION - will be awarded to any stallion, mare or gelding that has earned two official speed index ratings of 90 or higher (AAA) and earned a total of 40 points in recognized halter/performance halter and performance classes at five or more shows and under five or more different judges approved by AQHA or in races recognized by AQHA; providing that:

SHW808.1 A minimum of 15 of these points must be earned in halter/performance halter classes, with a minimum of eight of the points being earned during or after the horse's 2-year-old year. At least two grand champions, with five or more horses in the sex division, must have been earned under two different judges, with at least one of them being earned on or after the horse's 2-year-old year.

SHW808.2 At least 20 of those points must have been won in performance events at AQHA-approved shows or in races with at least eight of the 20 performance points earned in one or more of the following events:

Reining	Ranch Pleasure
Western Pleasure	Hunter Hack
Western Riding	Trail
Jumping	
Working Hunter	
Hunter Under Saddle	

SHW808.3 At least eight of the 20 performance points earned in one or more of the following events:

Tie-down Roping	Dally Team Roping-Heading
Cutting	Dally Team Roping-Heeling
Working Cow Horse	

SHW808.4 Rookie and Level I points do not count toward this award.

SHW809. SUPREME CHAMPION - YOUTH, AMATEUR - will be awarded when 50 points with one horse are earned in recognized halter/performance halter and performances classes at five or more shows and under five or more different judges providing that:

SHW809.1 A minimum of 15 of these points must be won in youth or amateur halter/performance halter classes, eight of which must have been earned during or after the horse's 2-year-old year,

SHW809.2 At least 20 points must be earned in youth or amateur performance events, with a minimum of five points having been earned in each of at least four categories of performance events as set forth in Achievement Awards.

SHW809.3 The remaining 15 points may be won in either youth or amateur halter/performance halter or youth or amateur performance events.

SHW809.4 Rookie and Level I points do not count toward this award.

SHW810. SUPERIOR (EVENT) HORSE - OPEN, AMATEUR, YOUTH - will be awarded to any stallion, mare or gelding in the open division, or in the amateur and youth division to the contestant and his/her horse in their respective division, that earned 50 or more points in one event, except for the title of superior race horse which requires 200 points.

SHW810.1 A horse in the open division or contestant and his/her horse in the amateur or youth division may receive this title for each separate event in which it has earned 50 points.

SHW810.2 Two hundred points are required for open division horses if the event is racing.

SHW810.3 In halter/performance halter, a minimum of 25 points must have been earned during or after the horse's 2-year-old year.

SHW810.4 Rookie and Level I exhibitor points do not count toward the superior award. Level I horse points do not count toward the superior award.

SHW811. PERFORMANCE CHAMPION AWARD - OPEN, AMATEUR, YOUTH - will be awarded to any stallion, mare or gelding in the open division, or in the amateur and youth division to the contestant and his/her horse in their respective division, that has earned three individual performance superior event horse awards

SHW812. SUPREME PERFORMANCE CHAMPION - AMATEUR, YOUTH - will be awarded to any youth or amateur earning six youth or amateur superior horse awards with the same horse in performance events; not including halter/performance halter.

SHW813. YEAR-END HIGH-POINT HORSE - OPEN, AMATEUR, YOUTH - will be awarded annually based on the number of points earned by an individual horse in the open division or an amateur or youth with any one horse in their respective division during that year's competition, in each AQHA-approved event in which points are awarded.

SHW813.1 Two or more AQHA trophies will be granted in the event of a tie in the Level 3 open, amateur and youth divisions. In the event of a tie for any corporate sponsored award, the winner will be:

a) Horse or contestant with the greatest number of wins

b) Horse of contestant winning over the greatest number of horses

c) Winner will be the exhibitor earning the final point the

earliest in the year

SHW813.2 Level 3 high point earners who have earned points in Level 3 classes will be recognized, in each event. The points must have been earned in Level 3 classes. Points earned in Level 2 are not included in the point counts. 1st place winners will receive a certificate of accomplishment, AQHA year-end high point trophy and personalized award buckle. 2nd through 10th will receive a certificate of accomplishment along with the opportunity to purchase an official AQHA Top-10 Year-End award.

SHW813.2.1 For a Level 3 year-end high-point performance halter award, a horse must earn at least 10 performance points in their respective division (open, youth, amateur) in Level 2 or 3 classes during the year in order to be eligible for a performance halter high-point (Example: If horse A has 100 performance halter gelding points and 16 western pleasure points and horse B has 135 performance halter gelding points and 7 western pleasure points, then horse A is eligible for year-end high point award in performance halter, but horse B is not eligible for the year-end high point award in performance halter).

SHW813.3 Open Junior and Senior high point horses and Top-10 amateurs and Top-10 youth with any one horse will be recognized, in each event. The top-10 earners will receive a certificate of accomplishment along with the opportunity to purchase an official AQHA Top-10 Year-End award.

SHW813.4 Open high point halter Stallion/Mare/Gelding will be recognized. The top-10 earners will receive a certificate of accomplishment along with the opportunity to purchase an official AQHA Top-10 Year-End award.

SHW813.5 Amateur Select exhibitors will be recognized, in each amateur event. The top-10 earners will receive a certificate of accomplishment along with the opportunity to purchase an official AQHA Top-10 Year-End award.

SHW813.6 At least one point must be earned in the youth division in an event for the year-end high-point award to be presented.

SHW813.7 Rookie level high point earners will be recognized, in each event. The top-10 exhibitors and top-10 horses will receive a certificate of accomplishment along with the opportunity to purchase an official AQHA Top-10 Year-End award.

SHW813.8 Level 1 high point earners will be recognized, in each event. The top-10 earners will receive a certificate of accomplishment along with the opportunity to purchase an official AQHA Top-10 Year-End award.

SHW813.9 Level 2 high point earners who have earned points in Level 2 classes will be recognized, in each event. The points must have been earned in Level 2 classes. The top-10 earners will receive a certificate of accomplishment along with the opportunity to purchase an official AQHA Top-10 Year-End award.

SHW814. YEAR-END HIGH-POINT EXHIBITOR - OPEN

- will be recognized based on the number of points earned by an individual in the open division during that year's competition.

SHW814.1 The exhibitor in the open division who earns more points during a calendar year than any other exhibitor will be

named the year's high-point exhibitor and an appropriate award will be given.

SHW814.2 Each of the top-10 point earning exhibitors for that year will be designated and a certificate mailed.

SHW814.3 In the event of a tie, the winner will be the exhibitor earning the final point the earliest in the year.

SHW814.4 Rookie and Level I points will not count toward high-point exhibitor award.

SHW815. YEAR-END ALL-AROUND HIGH-POINT HORSE AND RESERVE ALL AROUND - OPEN, AMATEUR, YOUTH - will be given to the horse in the open division, and the amateur and youth with any one horse in their respective division, earning the most points in halter/performance halter and performance classes at AQHA-approved shows.

SHW815.1 Points must be earned in halter/performance halter and at least two of the performance categories set forth in the all-around (open, amateur, Select amateur, youth) award with a minimum of five points earned in the lowest category.

SHW815.2 Rookie and Level I points will not count toward the all-around high-point horse award.

SHW815.3 A certificate will be awarded to the high-point Select exhibitor in each amateur class.

SHW816. LEVEL 2 EXHIBITOR OF THE YEAR - AMATEUR, YOUTH - will be awarded to the amateur and youth accumulating the most points on a one horse/one amateur/youth basis in the following age categories:

SHW816.1 Amateur Age Categories:

- 30 & under
- 31 - 49
- Select(50 and over)

SHW816.2 Youth Age Categories

- 11 and under
- 12 - 14
- 15 - 18

SHW816.3 To be eligible for the award, the eligible amateur or youth exhibitor;

SHW816.3.1 cannot have won any AQHA points (in Level 2 or Level 3 open, youth or amateur division) prior to the year of the award.

SHW816.3.2 must be a current member

SHW816.3.3 must have his/her birthdate on file with AQHA by December 15 of the year of the award

SHW816.4 In the event of a tie, awards will be distributed to the person (1) winning amateur/youth points in the greatest number of different events; (2) with the greatest number of amateur/youth wins.

SHW816.5 Rookie and Level I points earned previously or during the current year do not count against eligibility or towards tabulation for Level 2 rider of the Year Awards.

SHW817. SPECIAL ACHIEVEMENT RECOGNITION will be noted on a horse's record for outstanding achievements in special events not approved by AQHA. or special events results to be accepted, the following criteria must be met:

SHW817.1 The organization sponsoring the event must be national in scope and must apply to AQHA for approval of the event to be added to the list of events qualifying for this special recognition.

SHW817.2 The event must be open to all breeds of horses.

SHW817.3 After an event has been approved by AQHA as qualifying for this program, placings or standings of registered American Quarter Horses will be placed on that horse's record only if it placed first or second at that event or won \$10,000 or more in one approved event at one contest;

SHW817.4 The placings and/or standings must be provided to AQHA by the sponsoring organization within 60 days following the event.

SHW817.5 Alliances currently approved to submit Special Achievement Recognition events are:

- ABRA American Buckskin Registry Association
- CMSA..... Cowboy Mounted Shooting Association
- BFA Barrel Futurities of America
- IBHA..... International Buckskin Horse Association
- NCHA..... National Cutting Horse Association
- NRCHA National Reined Cow Horse Association
- NRHA..... National Reining Horse Association
- NSBA National Snaffle Bit Association
- PHBA Palomino Horse Breeders of America
- RHAA Ranch Horse Association of America
- RSNC Ranch Sorting National Championships
- SHOT Stock Horse of Texas
- USTPA United States Team Penning Association
- WCHA World Conformation Horse Association

SHW817.6 Any registered American Quarter Horse that competes in the Olympic Games qualifies for recognition.

wimpy | wim-pē | *adj.*

Lacking strength of will or character

Synonyms: frail, characterless, weak



DON'T LET THE NAME FOOL YOU.

Wimpy P-1 outlived his name and made history when he was hand-selected as the horse to receive registration number 1 in the American Quarter Horse Association registry.

Learn all their extraordinary stories at the American Quarter Horse Hall of Fame & Museum.
Plan your trip today at aqha.com/museum.

AMERICAN
QUARTER
HORSE
HALL of FAME
& MUSEUM

SHW900. AQHA-APPROVED JUDGES: Designation as an AQHA-approved judge is a privilege, not a right, bestowed by the Judges Committee according to procedures formulated by it, to individuals whose equine expertise and personal character merit the honor. Such designation is revocable by the Judges Committee with or without notice and formal hearing, subject only to ultimate review by the Executive Committee, with or without notice and formal hearing.

SHW901. An individual's conduct as a member, exhibitor and judge must be exemplary; is subject to continual review by the Judges Committee, with an automatic review after five years of becoming an AQHA judge.

SHW902. An AQHA-approved judge shall not have a conflict of interest between AQHA's objective and their own personal business or pecuniary interests. Each judge should refrain from using his or her official status to further one's own personal or financial purpose. When such conflict of interest arises, the judge is expected to either withdraw the personal objective from the transaction in question or resign as an AQHA-approved judge, so he or she may pursue the personal objective. Breach of this ethical rule shall be subject to review.

SHW903. If a judge cannot exercise an objective opinion, free from possible prejudice, bias or outside influence, because of a connection with an owner, exhibitor or anyone else connected with the horse, or, for that matter, if such connection would appear to others as possible bias, whether or not the judge feels he or she would be affected, a judge must disqualify himself or herself.

SHW904. These following specific areas of conflict of interest are not exclusive and judges are ineligible to judge any horse in other situations not designated by this rule. Certain specific areas of obvious conflict of interest for judges include:

SHW904.1 judging a horse that is owned or exhibited by anyone from whom he or she has received a salary, commission or any kind of remuneration for selling or buying any horse for that individual, whether or not a horse is concerned in the transaction, has been in the employ, or has represented such individual in any capacity for remuneration, within three months from the date of the subject show.

SHW904.2 personally exhibiting a horse at a show or set of shows at which he or she is judging.

SHW904.3 owning, in whole or part, a horse being exhibited at an approved show or set of shows held on the same show grounds in which that judge is officiating. However, the judge is allowed to judge speed events or Level I classes and be allowed to show at the same show or set of shows on the same show grounds.

SHW904.4 being involved in the management of a show while officiating as a judge at that show

SHW904.5 judging a horse belonging to or being exhibited by any member of his/her immediate family (spouse, son, daughter, father, mother, sister, brother.)

SHW904.6 judging a horse that he/she has been owner, trainer, agent in any capacity, or conditioner of that horse within the previous three months.

SHW905. TO MAINTAIN APPROVAL AS A JUDGE, an individual must:

Rule SHW905.1- maintain a current individual membership failure to do so will result in removal from the list of AQHA-approved

judges. If removed for failure to maintain an individual membership, the judge must wait 12 months from the date their membership is activated to reapply for judging credentials.

SHW905.2 attend an AQHA-sanctioned judges conference once every two-years beginning January 1 of the year in which the individual becomes an AQHA-approved judge; furthermore, all AQHA-approved specialized judges must attend a judges conference when their discipline is conducted.

SHW905.3 attain a minimum of three credits from AQHA-approved shows per calendar year beginning January 1 of the year following the individual's approval as an AQHA-approved judge. In cases where four or more, show numbers are judged at the same show, or set of shows, only four credits will be counted against the maximum of 25 shows for that judge. AQHA-approved specialized judges must earn a minimum of one credit every three years beginning the date they go on the list of AQHA-approved judges. This credit may be earned by judging an AQHA approved show or an alliance show in the discipline for which they are approved. An individual who has served as a panel member for an AQHA-sanctioned judges conference; a panel member for an AQHA-sanctioned educational judging seminar; and/or an official judge for an AQHA-sanctioned qualifying exam will receive credit for one show judged.

SHW905.4 hold and maintain a judges card with the alliance in that discipline (i.e NCHA, NRHA, NRCHA, USTPA, WCHA) to serve as a specialized judge.

SHW906. GROUNDS FOR REMOVAL as an AQHA-approved judge shall include, but not be limited to:

SHW906.1 suspension from AQHA membership or denial of any privilege thereof.

SHW906.2 failure to comply with AQHA's rules and regulations.

SHW907. Removal of an individual as an AQHA-approved judge, for any reason, shall be absolute, with no provision for automatic reinstatement.

SHW908. An individual who is suspended from AQHA membership or is denied AQHA privileges may not apply to become an AQHA-approved judge until the expiration of one year following reinstatement of AQHA membership or privileges.

SHW909. INTERNATIONAL AQHA-APPROVED JUDGES residing in an international country may make four trips or judge four shows in any one country in a calendar year, excluding Canada.

SHW910. A JUDGE SHALL:

SHW910.1 judge an AQHA-approved event in accordance with all rules, regulations, directives and guidelines issued by AQHA.

SHW910.2 honestly, fairly and impartially judge each horse exhibited to him or her, strictly on the horse's conformation and/or its performance as the rules of the particular event dictate.

SHW910.3 at all times act in a professional manner.

SHW910.4 disqualify any contestant for abuse of the horse.

SHW910.5 eliminate any horse/exhibitor as an entry which he/she feels is in violation of the intent of AQHA's prohibited conduct rules, or which he/she does not feel has legitimately attempted to exhibit the horse to the best of the horse's ability.

SHW910.6 adhere to the AQHA Judge Code of Ethics.

SHW910.7 during an approved show, be present to meet his/her responsibilities under AQHA rules and shall be available to assist

show management in meeting its responsibilities of rule compliance.

SHW910.8 make every reasonable effort to judge a show after accepting a judging commitment. If unable to fulfill the commitment, the judge must notify show management in a timely manner to allow show management maximum time to secure a suitable replacement. The judge must also immediately notify AQHA in writing with a complete explanation of the failure to meet the commitment, including the time, date and manner that show management was notified.

SHW910.9 contact an official of the show upon arrival in a city in which he/she is to officiate and advise him/her of his/her presence and location.

SHW910.10 wear western attire, including hat and boots, while judging an AQHA-approved show except when judging a dual approved AQHA/USEF hunter competition when they may wear appropriate English judging attire.

SHW910.11 be at least 21 years of age to serve as a specialized Level I show judge or 25 years of age to judge all other approved shows/events.

SHW911. JUDGES MAY:

SHW911.1 judge two judged special events in the same state; province or country within one calendar year.

SHW911.2 order any person or horse from competition for poor conduct of either.

SHW911.3 at his/her discretion, refuse entry into the arena or remove an entry from a class for improper attire and/or equipment.

SHW911.4 use the ring steward, other show officials or approved AQHA judges to assist in scoring individual jumps in jumping.

SHW911.5 An AQHA-approved judge may charge a fee lower than the \$200 minimum for Versatility Ranch Horse competitions, Level I shows, special events and Equestrians with Disabilities events.

SHW911.6 At all shows where there is an official videographer judges will be allowed to review 2-point penalties for break of gait, jogging more than two (2) strides and freeze ups as long as one (1) judge has called the penalty 2.

SHW912. JUDGES MAY NOT:

SHW912.1 judge two consecutive years at the same show, set of shows or circuit except when judging cutting, working cow horse, roping, team penning, ranch sorting, speed events, ranch riding or versatility ranch horse where they may judge up to two consecutive years.

SHW912.2 make more than three trips to one state, province or country to judge within one calendar year. One of the trips must be a single day show if three trips are made.

SHW912.3 judge two shows within 150 miles of each other within 30 days, except he/she may judge multiple shows on the same grounds on consecutive days as long as the judge does not judge a particular class but one time during those shows.

SHW912.4 appear on the show grounds more than one hour before the judging.

SHW912.5 visit the stall area, nor visit with owners, trainers, exhibitors or owners' representatives, nor inspect or discuss any horse entered in the show before the judging (including the day prior to the contest).

SHW912.6 visit, socialize or fraternize with any exhibitor the day

prior to or during the show.

SHW912.7 review the program until after the judging has been completed; but he/she shall be furnished a schedule of events by the show management prior to the judging.

SHW912.8 ride or, in any manner, participate in the role of an exhibitor for a horse in the class while judging an event.

SHW912.9 ask the exhibitor to change horses with another exhibitor.

SHW912.10 rejudge a class once it has been judged.

SHW912.11 change his/her score card (record) after awards have been presented unless a clerical error has occurred. In the event of a clerical error, validated by proper documentation, the clerical error must be corrected before show results are entered by AQHA.

SHW913. IT IS THE JUDGE'S RESPONSIBILITY TO:

SHW913.1 control the cattle pens and treatment of all cattle in cattle classes.

SHW913.2 have bridles dropped in at least one class per show.

SHW913.3 allow exhibitors in individually worked classes who incur a penalty of 0 to complete the pattern as long as they stay within reasonable confines of the described pattern or course, stay within a reasonable working time allowed for the pattern or course and avoid abusive or excessive training.

SHW913.4 submit all score sheets to show management to be posted.

SHW913.5 rely on the ring steward to facilitate an exhibitor's request to speak directly to him/her. When an exhibitor makes a request through the ring steward or other show official for the judge's opinion concerning that exhibitor's horse, the judge will give his/her opinion courteously and sincerely in the presence of the ring steward or other show official.

SHW914. IN ANY PERFORMANCE CLASS, the judge:

SHW914.1 shall not call contestants off the rail at any gait other than a walk, where horses are worked on the rail.

SHW914.2 may, at his/her discretion, require the backing of only the finalists in the class where backing is required.

SHW914.3 may at his/her discretion penalize the horse, anytime a horse is ridden with a hackamore and has an open, raw or bleeding sore that comes in contact with the hackamore, or if the horse appears sullen, dull, lethargic, emaciated, drawn or overly tired.

SHW914.4 must disqualify a horse any time a horse's mouth is bleeding

SHW914.5 is not to penalize a horse for the manner in which it carries its tail nor for normal response with its tail to cues from its rider or when changing leads. A judge may, at his/her discretion, penalize a horse for excessive or exaggerated switching or wringing of the tail or for a seemingly dead tail that merely dangles between the legs and does not show normal response.

SHW914.6 the fall of a horse or rider being judged shall be cause for disqualification in all classes except for team penning and ranch sorting. A horse is considered having fallen when he or she is on their side and all four feet are extended in the same direction. Rider is considered to have fallen when he or she is not astride.

SHW914.7 shall disqualify a horse any time its mouth is tied or fastened.

SHW914.8 must inspect horses in at least one class per show by

examining both sides, front and rear for signs of abuse or excessive training.

SHW915 CLASS PLACINGS - A judge must place

SHW915.1 through nine places in classes where there are 9-34 qualified horses exhibited

SHW915.2 through 10 places in classes of 35-39 horses

SHW915.3 through 11 places in classes of 40-44 horses

SHW915.4 through 12 places in classes of 45 or more horses.

SHW915.5 All qualified horses in classes of nine or less. If a horse is disqualified, however, it is not to be placed regardless of the number of horses in the class.

PROPER ENGLISH



The American Quarter Horse Association has a variety of options for members wishing to compete at all levels. Find an AQHA-approved event, purchase your Youth membership and much more.

AQHA



RACING RULES AND REGULATIONS

IMPORTANT NOTICE: The welfare of the horse and all other animals is paramount to AQHA. Before proceeding, please read AQHA's welfare statement concerning American Quarter Horse racing on page 3. RAC30I.4 and RAC3II are examples of ways that AQHA has worked to protect horses involved in racing.

RAC300. GENERAL RACING PROVISIONS

RAC300.1 AQHA does not assume or accept duty or responsibility for safety at any race or races in regard to participants, third parties or participating horses.

RAC300.2 As an express condition of the privilege to participate at an AQHA-recognized race event, each owner of an American Quarter Horse, trainer and participant assumes the risks of participation and releases and discharges AQHA, its officers, directors, representatives and employees from any and all liability, whenever or however arising, as to personal injury or property damage occurring as a result of participation in a race event.

RAC300.3 In cases where races eligible for AQHA recognition are run under the supervision of a Racing Authority, the Racing Authority's rules take precedence. While rules of Racing Authorities take precedence, AQHA, for purposes of AQHA records and programs, reserves the right to deny or revoke recognition of a race which does not observe the rules and regulations contained herein. American Quarter Horse racing is defined as two or more American Quarter Horses registered with the American Quarter Horse Association, entered and competing in the same race at the same time from a regulation starting gate, at distances and conditions recognized by AQHA and running at full speed, unimpeded by obstacles, thru a common finish line. Also see rules RAC30I and RAC302.

RAC30I. RACE RECOGNITION AND RESULTS

RAC30I.1 AQHA accepts race results in Amarillo, Texas, as official and uses such results for purposes of recording information in AQHA records, conducting AQHA racing programs and determining qualification for advancement of a horse in AQHA's breed registry.

RAC30I.2 Race results are eligible for AQHA recognition if the race is run under the supervision of a Racing Authority and complies with the rules and regulations contained herein.

RAC30I.3 Effective April 1, 1992, AQHA imposed a moratorium on applications for AQHA sanction/regulation of nonpari-mutuel race meets. Such moratorium remains in effect and may only be waived by the AQHA Executive Committee.

RAC30I.4 AQHA will not recognize a race that involves an American Quarter Horse competing with horses other than

RAC30I.4.1 other American Quarter Horse(s);

RAC30I.4.2 Thoroughbred(s) registered with The Jockey Club, The Canadian Jockey Club or The Mexican Jockey Club;

RAC30I.4.3 horse(s) registered with the American Paint Horse Association; or

RAC30I.4.4 horse(s) registered with the Appaloosa Horse Club.

RAC30I.5 AQHA will not recognize a race in which a 2-year-old:

RAC30I.5.1 starts prior to March 1 (with the exception of the trials and finals for the West Texas Futurity and the Mardi Gras Futurity);

RAC30I.5.2 competes against older horses; or

RAC30I.5.3 is allowed to compete at a distance greater than 440

yards prior to September 1.

RAC301.6 A questionable time is a time in which past performance records indicate possible error.

RAC301.6.1 In cases of questionable times, AQHA may withhold its recognition of the times as official until the race is reviewed by AQHA.

RAC301.6.2 If presiding race officials or the Racing Authority do not provide reasonable justification for the questionable time, AQHA reserves the right to adjust the time by using the video of the race to estimate the time by counting the number of video frames in the race from the moment the starting gate stall doors are fully open parallel to the racing track.

RAC301.6.3 AQHA decisions regarding questionable times may be appealed to the AQHA Racing Council for further consideration. Decisions of the Racing Council may be appealed to the AQHA Executive Committee per VIO505.

RAC302. TRACK RESPONSIBILITIES

RAC302.1 Unless otherwise specified herein, AQHA recognizes the Model Rules for Flat Racing adopted by the Association of Racing Commissioners International ("ARCI") and requests that races eligible for AQHA recognition be run in accordance with such rules.

RAC302.2 AQHA recommends that all stewards at American Quarter Horse tracks be certified as accredited stewards and have adequate experience and/or education concerning American Quarter Horse racing.

RAC302.3 Tracks must file race results charts and official programs with AQHA following each racing day. Tracks may file such charts and programs by fax, online computer transmission (directly to AQHA or via submission to Equibase) or express delivery. The race results chart should include all of the necessary information to produce past performance lines as well as information concerning monies earned (purse and bonus) paid through the horseman's bookkeeper. The official program should include conditions of the races and distances, names of the horses in each race, post positions, color, sex, age, breeding, owner, trainer, jockey and weight carried.

RAC302.4 If requested by AQHA, tracks must provide AQHA with a videotape of all graded or restricted graded stakes races at the track's expense.

RAC302.5 The track is responsible for setting starting gates so races are actually run at designated distances. There shall not be a downhill slope in excess of one degree (1°) over the length of the straightaway. At AQHA's request, a track must file with AQHA a certified statement by a licensed surveyor that all American Quarter Horse distances at the track have been surveyed for grade and distance within the last five years.

RAC302.6 AQHA will only recognize those official races that are run on oval tracks that meet the standards and requirements of AQHA and the model rules of racing.

RAC302.7 All tracks conducting American Quarter Horse racing shall utilize an electronic photo-finish camera or computerized video tape photo-finish camera. The minimum accuracy of the camera shall be no less than 1/100th (.01) of a second. The maximum accuracy of the camera shall be no greater than 1/1000 (.001) of a second. The track must calibrate the photo-finish camera every year and, at AQHA's request, file a copy of the calibration report with AQHA.

RAC302.8 The recommended minimum scale of weights of American Quarter Horse jockeys riding 2-year-olds is 120 pounds; 3-year-olds is 122 pounds; and 4-year-olds or older is 124 pounds.

RAC303. EARNINGS. AQHA will only record the following as total money earned in the Official AQHA Race Record:

RAC303.1 Purse earnings reported in the race results chart; and

RAC303.2 Bonus earnings, including annuity awards, that are:

RAC303.2.1 paid to the owner(s) of a horse as a result of the horse's performance in a specific race or series of races that are not included in the actual purse of the race(s) but are paid through the horseman's bookkeeper (in the case of a series of races, paid through the horseman's bookkeeper at the track where the last leg of the series was held); and

RAC303.2.2 reported in the race results chart.

RAC303.3 Bonus earnings will be recorded separately from purse earnings, and an annotation will appear on materials such as Champions Balloting specifying that the horse's total earnings include a particular amount of bonus earnings.

RAC303.4 Bonus earnings in the form of an annuity award will be recorded as the cash value of the annuity on the date the award was earned, whether or not the owner receives the award as a lump sum or in periodic payments. In the event an owner receives an annuity award in periodic payments, the determination of the cash value of the annuity on the date the award was earned shall be in accordance with generally accepted accounting principles.

RAC303.5 AQHA records all monetary amounts reported as part of race results (purses, bonus earnings, claiming prices, wagering pool, payoffs, etc.) in U.S. funds.

RAC304. HORSE OWNERSHIP.

RAC304.1 "AQHA Race Ownership Record" shall mean a horse's official AQHA ownership record as it existed within AQHA's ownership data system at the time of a race.

RAC304.2 A person shall be considered a "Record Owner" of a horse if such person is:

RAC304.2.1 listed as the owner per "AQHA Race Ownership Records"; or

RAC304.2.2 listed as the lessee per "AQHA Race Ownership Records".

RAC304.3 For purposes of AQHA recognition and AQHA awards only, points and earnings earned as a result of a horse's performance in a particular race ("AQHA Credit") shall only be credited to the Record Owner of such horse for that race.

RAC304.4 AQHA recognizes that reporting services and/or racetracks, for purposes of their record keeping, may rely on certain documentation as being sufficient for their official and final determination/recognition of a person as being the owner of a horse. AQHA recognizes that such documentation might include, but not necessarily be limited to:

RAC304.4.1 an AQHA registration certificate presented to race officials;

RAC304.4.2 an AQHA lease certificate presented to race officials; or

RAC304.4.3 a valid transfer report presented to race officials. Notwithstanding such reliance and official and final determination/recognition by reporting services and/or racetracks, if a

person is not a Record Owner as defined in subsection RAC304.2 above, such person shall not receive the AQHA Credit referenced in subsection RAC304.3 above. This remains true even if AQHA official ownership records are subsequently updated after a race to reflect that such person was the owner of the horse at the time of the race.

RAC304.5 See REG124.6 for information on transferring horses claimed in claiming races.

RAC305. TIME TRIALS. In the absence of specific conditions for particular elimination or time trial races, the following rules shall apply.

RAC305.1 Except in cases where the starting gate physically restricts the number of horses starting, each time trial shall consist of no more than 10 horses.

RAC305.2 The time trials shall be raced under the same conditions as the final. If the time trials are conducted on the same day, the horses with the 10 fastest times shall qualify to participate in the final. If the time trials are conducted on two days, the horses with the five fastest times on the first day and the horses with the five fastest times on the second day shall qualify to participate in the final. When time trials are conducted on two days, the racing secretary shall make his/her best effort to split owners with more than one entry into separate days and/or time trials.

RAC305.3 If the track's starting gate has less than 10 stalls, then the maximum number of qualifiers will correspond to the maximum number of starting gate post positions.

RAC305.4 Except in races around a turn, if only 11 or 12 horses are entered to run in time trials from a gate with 12 or more stalls, the track may choose to run a final only. If 11 or 12 horses participate in the final, only the first 10 finishers will receive purse money.

RAC305.5 In the time trials, horses shall qualify on the basis of time and order of finish. The times of the horses in the time trial will be determined to the limit of the timer. The only exception is when two or more horses have the same time in the same trial heat. Then the order of finish shall also determine the preference in qualifying for the final. Should two or more horses in different time trials have the same qualifying time to the limit of the timer for the final qualifying position(s), then a draw by public lot shall be conducted as directed by the stewards. Qualifying times in separate trials shall not be determined beyond the limit of the timer by comparing and/or enlarging photo-finish images.

RAC305.6 Except in the case of disqualification, under no circumstances shall a horse qualify ahead of a horse that finished ahead of that horse in the official order of finish in a time trial.

RAC305.7 Should a horse be disqualified for interference during the running of a time trial, it shall receive the time of the horse it is immediately placed behind plus one hundredth of a second, or the maximum accuracy of the electronic timing device. No adjustments will be made in the times recorded in the time trials to account for head-wind, tail-wind, off-track, etc. If a horse is disqualified for interference with another horse causing loss of rider or the horse not to finish the race, the disqualified horse shall be given no time and that horse should not be eligible to run in the final.

RAC305.8 Should a malfunction occur with the electronic timer on any time trial, finalists from that time trial will then be determined by official hand times operated by three official and disinterested persons. The average of the three hand times will be utilized

for the winning time, unless one of the hand times is clearly incorrect. In such cases, the average of the two accurate hand times will be utilized for the winning time; other horses shall be given times according to the order and margins of finish with the aid of the photo finish, if available.

RAC305.9 When there is a malfunction of the timer during some time trials, but the timer operates correctly in other time trials, the accurate electronic times shall not be discarded, nor shall the average of the hand times be used for all time trials.

RAC305.10 If the accuracy of the electronic timer and/or the average of the hand times are questioned, the video of a time trial may be used by the stewards to estimate the winning time by counting the number of video frames in the race from the moment the starting gate stall doors are fully open parallel to the racing track. When the timer malfunctions and there are no hand times, the stewards may select qualifiers based on the video.

RAC305.11 Should there be a malfunction of the starting gate and one or more stall doors not open or open after the exact moment when the starter dispatches the field, the stewards may declare the horses with malfunctioning stall doors non-starters or may allow any horse whose stall door opened late, but still ran a time fast enough to qualify, to be declared a starter for qualifying purposes. If a horse breaks through the stall door, or the stall door opens prior to the exact moment the starter purposely dispatches the field, the horse may be declared a non-starter, and the stewards may direct that all entry fees be refunded. If one or more, but not all, stall doors open at the exact moment the starter purposely dispatches the field, these horses should be considered starters for qualifying purposes and placed according to their electronic time. If the electronic timer malfunctions in this instance, the average of the hand times, or if not available, the video may be utilized for the horses declared starters.

RAC305.12 If a horse should be scratched from the time trials, the horse's owner shall not be eligible for a refund of the fees paid and shall not be allowed to enter the final. If a horse that qualified for the final should be unable to enter due to racing soundness or scratched for any reason other than a positive drug test or a rule violation, the horse shall be deemed to have earned and the owner will receive last place purse money. If more than one horse is scratched from the final, then those purse monies shall be added together and divided equally among those owners.

RAC305.13 If a qualifier for a final or consolation is disqualified for ineligibility or a rule violation after the time trials are declared official, but prior to entry for the final or consolation, the non-qualifier with the next fastest time shall replace the disqualified horse. If a qualifier is disqualified after entry for the final or consolation for any reason other than racing unsoundness, illness or death, if necessary, the purse shall be redistributed among the remaining qualifiers.

RAC306. STAKES AND RESTRICTED STAKES RACES.

In order to be eligible for AQHA recognition as a stakes or restricted stakes race, the following conditions must be met:

306.1 Stakes race – A stakes race is a race in which any horse must make nomination(s), sustaining and/or entry fee payment(s), or a supplemental payment to participate in a race.

306.1.1 Nominations must close more than 48 hours before

time for the first race of the day on which such stake(s) race(s) is conducted.

306.1.2 Must be worth a minimum of \$15,000 to be considered

306.1.3 Can either be considered open or restricted

306.1.4 Eligible for grading when it meets the conditions for a graded stakes race

306.1.5 Conditions and/or nomination form along with purse structure must be on file with the AQHA Racing Office in Amarillo, TX at the same time the information is sent to horsemen.

306.1.6 The minimum purse for stakes races conducted internationally shall be \$7,500 U.S. funds, based on the conversion rate on each race day, except Canada where the minimum is \$15,000 Canadian funds.

306.1.7 Races not eligible for stakes race status include but not limited to:

306.1.7.1 match races

306.1.7.2 races restricted to horses that are non-winners of a stakes race

306.1.7.3 races that are restricted to maidens, limit eligibility to horse that have started for a claiming price, horses entered to be claimed or that carry an optional-claiming condition.

306.1.7.4 races that use a speed number (index, rating, etc).

306.1.7.5 any trial races, with the exception of the Z Wayne Griffin Directors trials

306.2 Open stakes race – A race at which any horse at any time can make a payment(s) and enter the stakes race or trials for that particular stakes race according to the conditions of the race.

306.2.1. Can only limit entry by sex or age

306.2.2. An invitational (horses must have competed in a stakes race(s) to be invited) or handicap can be considered a stakes race if it meets the minimum purse, is advertised in the official stakes program and satisfies all other criteria. This includes juvenile or “consolation” races for horses that ran in trials but did not qualify for the final.

306.3 Restricted stakes race – A race that limits entry of horses based on any other criteria other than age or sex. This includes but is not limited to the following:

306.3.1. state breeding, foaling and/or ownership

306.3.2. horses that were sold in a certain sale

306.3.3. progeny of a group of stallions either owned or standing at certain stallion farm(s)

306.3.4. tend to exclude better horses while allowing participation by lesser horses

306.3.5. raced in certain states or at certain tracks

306.4 Graded stakes races – Annually, AQHA will consider for grading, all eligible open and restricted stakes races as outlined in the Graded Stakes Committee Guidelines. Stakes may be graded as Grade 1, 2 or 3, with Grade 1 being the highest grade. Restricted stakes may be graded as Restricted 1, 2 or 3, with Restricted 1 being the highest grade. Primary considerations for grading will be the quality of horses attracted

to the race and such factors as competition, conditions, purse and prestige of the race. In order for AQHA to grade a stakes race, such race must limit entry and competition to only American Quarter Horses registered with the American Quarter Horse Association.

Races not eligible for graded stakes status but could still qualify for stakes race status:

306.4.I. Overnight stakes races

A race whose conditions give preference to or are limited to non-qualifiers of another graded or non-graded stakes race

RAC307. THE BANK OF AMERICA® RACING CHALLENGE. The general rules and conditions for the Bank of America® Racing Challenge are contained in the Official AQHA Bank of America® Racing Challenge Condition Book applicable to the year in which the Challenge races are conducted (“Official Challenge Condition Book”). The Official Challenge Condition Book is published on AQHA’s website (*aqha.com*) and is incorporated herein by reference.

RAC308. SPEED INDEX. Speed index is a system of rating the performance of American Quarter Horse racehorses.

RAC308.I Speed index ratings are based on an average of the three fastest winning electronic times at a particular distance run each year for the immediate past three years at a given track (nine total times). The average of the nine times (to the nearest 1/1000 (.001) of a second) represents a speed index rating of 100 for the following year.

RAC308.I.I In the event a time included within the nine times is slower than the established Minimum Standard Time for that distance, the Minimum Standard Time will be used in lieu of such slower time in calculating the average from which the speed index ratings will be computed the following year.

RAC308.I.2 No horse will be used more than one time in any one year at a particular distance at any one track in calculating the nine fastest times.

RAC308.2 The following times constitute Minimum Standard Times.

OFFICIAL DISTANCE	MINIMUM STANDARD TIME (for 100 Speed Index Rating)
110 yards - straightaway	6.98
220 yards - straightaway	11.95
250 yards - straightaway	13.35
300 yards - straightaway	15.55
330 yards - straightaway	16.95
350 yards - straightaway	17.85
400 yards - straightaway	20.15
440 yards - straightaway	22.05
550 yards - straightaway	27.70
660 yards - straightaway	33.50
660 yards - around one turn	34.60
770 yards - around one turn	40.36
870 yards - around one turn	45.60
1,000 yards - around one turn	52.41

RAC308.3 In the event a track does not have a three-year immediate history for a particular distance, but, at least once in the immediate past three years has recorded three fastest winning electronic times at a particular distance, then the speed index of 100 will be based on the average of:

RAC308.3.1 the Minimum Standard Time for those year(s) that the track did not run the particular distance; and

RAC308.3.2 average of the three fastest winning electronic times in each of the years that the race was run in the immediate past three years (average of 3 times if distance only run during 1 meet in the last 3 years or average of 6 times if distance run during 2 meets in the last 3 years)

RAC308.4 In the event a track has not recorded three fastest winning electric times at a particular distance at least once in the immediate past three years, but is a track that has run races that AQHA has recognized in the past, then the speed index of 100 will correspond to the Minimum Standard Time for that particular distance.

RAC308.5 Horses starting at tracks eligible for recognition by AQHA for the first time will receive a speed index rating based on the following:

RAC308.5.1 First year: A speed index of 100 will be based on an average of the three fastest winning electronic times at a particular distance run for the previous year at each of the five tracks with the largest number of race starters the previous year (hereinafter referred to as the "Five Track Average"). No horse will be used more than one time in any one year at a particular distance at any one track.

RAC308.5.2 Second year: A speed index of 100 will be based on an average of the Five Track Average and the average of three fastest times at the track in question for the previous year. No horse will be counted more than once at a particular distance at any one track.

RAC308.5.3 Third year: A speed index of 100 will be based on an average of the Five Track Average and the average of the three fastest times at the track in question for the previous two years. No horse will be counted more than once at a particular distance at any one track.

RAC308.6 A speed index point varies according to the distance of the race as follows:

.100 equals one speed index point at 1,000 yards.

.087 equals one speed index point at 870 yards.

.077 equals one speed index point at 770 yards.

.066 equals one speed index point at 660 yards.

.055 equals one speed index point at 550 yards.

.044 equals one speed index point at 440 yards.

.04 equals one speed index point at 400 yards.

.035 equals one speed index point at 350 yards.

.033 equals one speed index point at 330 yards.

.03 equals one speed index point at 300 yards.

.025 equals one speed index point at 250 yards.

.022 equals one speed index point at 220 yards.

.011 equals one speed index point at 110 yards.

RAC308.7 To calculate a specific speed index for a specific horse in a specific race, the time run by the horse is compared to the speed index time associated with 100 for the distance in question at that particular track. Points are added or subtracted based on whether the time was faster or slower than 100 speed index time. The only exception to the point interval chart above relates to a horse achieving a speed index of 101. In order to achieve a speed index of 101, a horse need only be .01 faster than the speed index time associated with 100. Thereafter, speed indexes greater than

IOI are calculated using the speed index point intervals above. By way of example, if a 100 speed index associated with a 350 yard race is 17.75, then a horse that runs a 17.74 shall earn a speed index of IOI. Using the same example, if the horse runs a 17.705 (.035 faster than 17.74), then such horse shall earn a speed index of IO2.

RAC308.8 An American Quarter Horse may not earn a speed index at a distance exceeding **1,000** yards or around more than one turn. However, such races will be listed on the participating horse's race record.

RAC308.9 A speed index will only be awarded to a horse for approved electronic times at AQHA recognized official distances.

RAC309. RACING POINTS.

RAC309.1 Racing points will be awarded according to conditions of the race and order of finish for all races recognized by AQHA, at official AQHA distances. (See chart on page 297.)

RAC309.2 Starter allowance and optional claiming races are considered in the same category as claiming races, based on claiming and optional claiming price.

RAC309.3 Should a dead heat occur, all horses involved will receive the same points based on the place for which they dead heated. All other horses will receive points based on their actual finish.

RAC309.4 Unless otherwise specified herein, a disqualified horse will receive points according to its final placement.

RAC309.5 Horses participating in match races or races with less than five horses on the race card will receive no race points.

RAC309.6 AQHA's Racing Department shall be responsible for making the final decision as to which category a race shall be placed.

RAC310. RACING AWARDS AND CHAMPIONS.

RAC310.1 For the purpose of racing awards, a male horse that has not been gelded shall be considered a colt at 2 and 3 years old, and a stallion at 4 years and older. For the purpose of racing awards, a female horse shall be considered a filly at 2 and 3 years old, and a mare at 4 years and older.

RAC310.2 World Champion and Champion Racing American Quarter Horses will be awarded annually by vote of the Champions Selection Committee and in accordance with Champion Selection Committee guidelines.

RAC310.2.1 Awards will be given as follows: champion 2-year-old colt; champion 2-year-old filly; champion 2-year-old gelding; champion 3-year-old colt; champion 3-year-old filly; champion 3-year-old gelding; champion aged stallion; champion aged mare; champion aged gelding; and champion distance horse of the year.

RAC310.2.2 In each age division, a champion will be named; those being champion 2-year-old, champion 3-year-old and champion aged horse.

RAC310.2.3 Voters are instructed to select the overall World Champion American Quarter Horse from their choices for the three age divisional champions.

RAC310.2.4 Champion honors will be considered for American Quarter Horse Racing conducted internationally upon request from the host country's AQHA affiliate, providing there is a significant race season and pari-mutuel wagering is conducted.

RAC310.2.5 An appropriate award will be given the horse's record owner as of December 31.

RAC310.3 Champion owner, breeder, trainer and jockey will be awarded annually by written ballot. The five top-ranked individuals with the best overall placings according to money earned, races won and points earned will be placed on a ballot. An appropriate award will be presented to the selected persons.

RAC310.4 Regional High Point Champions will be awarded annually to the highest point earner in each of 10 regions and each of 12 categories.

RAC310.4.1 Awards will be given in the following categories: 3-year-old colt; 3-year-old filly; 3-year-old gelding; aged stallion; aged mare; aged gelding; distance and claiming. In addition, an award will be given to the top jockey, trainer, owner and breeder in each region.

RAC310.4.2 The distance horse in each region will be based upon points earned in regional races at distances of 550 yards and longer.

RAC310.4.3 The claiming horse in each region will be based upon points earned in regional claiming races.

RAC310.4.4 An appropriate award will be given to the horse's record owner as of December 31.

RAC310.5 Superior Race Horse will be awarded to any American Quarter Horse that earns 200 racing points.

RAC310.6 Supreme Race Horse will be awarded to any American Quarter Horse that has achieved each of the following:

RAC310.6.1 earnings of \$500,000 or more

RAC310.6.2 winner of two open Grade I (GI) stakes races or two races of Grade I historical significance prior to 1983; and

RAC310.6.3 winner of ten races.

RAC310.7 World and Track Records. AQHA designation as a new/tied world or track record will be awarded under the following circumstances:

RAC310.7.1 the winning time is equal to or faster than the existing record.

RAC310.7.2 the second-place time is equal to or faster than the existing record, if the winner is disqualified.

RAC310.7.3 the race must be electronically timed.

RAC310.7.4 the race is run at an official surveyed distance.

RAC310.7.5 at a racetrack racing for the first time, or racing for the first time in 10 years or longer, the fastest winning time for the race meet at each distance will be recognized as the track record.

RAC310.7.6 at a distance that is being run for the first time at that racetrack, or the first time in ten years or longer, the fastest winning time for the race meet at each distance will be recognized as the track record.

RAC310.7.7 in order to be recognized as a record, a speed index of 80 or better must be achieved.

RAC310.8 Dam of Distinction will be awarded to any American Quarter Horse mare that meets at least one of the following criteria:

RAC310.8.1 produced two or more individual Champion Racing American Quarter Horses.

RAC310.8.2 produced at least three individual American Quarter Horse Grade I stakes winners.

RAC310.8.3 produced at least two American Quarter Horse foals ranked in the top ten money earners of any particular year (as of December 31 of that year) and two GI stakes winners.

RAC310.8.4 produced at least three American Quarter Horse foals that were in the top ten money earners of any particular year (as of December 31 of that year).

RAC310.8.5 produced at least three individual American Quarter Horse stakes winners prior to 1983 and those wins were equivalent of Grade I quality race.

RAC310.9 Horses earning a speed index of 80 or higher will receive a Racing Register of Merit. AQHA will furnish a Register of Merit certificate to the horse's owner at the owner's request. If the electronic timer malfunctions but a hand-time is recorded that would have resulted in a speed index of 80 or higher, the owner of the horse may appeal to AQHA for designation of the horse a Register of Merit qualifier if the hand-time is certified by track stewards.

RAC310.10 Membership in AQHA on the date the award is bestowed is required for the owner of an American Quarter Horse to receive any racing award for achievement, including, but not limited to, a certificate, plaque or trophy. Despite owner ineligibility, the horse's achievement will, however, be recorded in its permanent record. To become eligible to receive the award, the owner may retroactively purchase the required annual membership.

RAC311. DISCIPLINARY ACTIONS

RAC311.1 Upon official notice to AQHA by the disciplining Racing Authority, a person who is suspended or otherwise disciplined by a Racing Authority for their conduct associated with an AQHA-recognized race may be suspended or disciplined by AQHA for the following:

RAC311.1.1 positive lab result involving forbidden substances detected in horses entered in a race;

RAC311.1.2 positive lab result involving an overage of a conditionally permitted therapeutic medication;

RAC311.1.3 possession of electrical devices in the course of a recognized race meeting;

RAC311.1.4 racing a ringer for fraudulent purposes; and

RAC311.1.5 multiple offenses for the same ownership.

RAC311.2 In addition to affording reciprocity to a racing authority, AQHA reserves the right to impose additional fines, suspend AQHA membership privileges and suspend participation privileges (both individual and horse) in AQHA-approved/recognized events. Included within such disciplinary actions are those disciplinary actions set forth in AQHA's Multiple Medication Violations System (MMVS). The MMVS sets forth penalties for trainers, owners and horses subject of positive drug tests, and, in particular, is designed to assess penalties against trainers, owners and horses subject of positive drug tests for forbidden substances and/or subject of multiple positive drug tests involving forbidden substances and/or overages of therapeutic medications. A copy of the MMVS can be found on the Racing Welfare and Medication web page at aqha.com/racing.

RAC311.3 Notwithstanding anything to the contrary contained in AQHA's Disciplinary and Appeal Procedure Rules, no person who is suspended or disciplined by a Racing Authority and/or under Rules RAC311.1-2 shall be entitled to a hearing before the Executive Committee or an AQHA hearing committee.

RAC311.4 A horse may not receive an official speed index or racing points for having started in the race, if:

RAC311.4.1 its owner is:

RAC311.4.1.1 currently under AQHA suspension;

RAC311.4.1.2 ineligible for a license; or

RAC311.4.1.3 ineligible to participate under the rules of any racing authority or breed registry

RAC311.4.2 a racing authority disqualifies the horse from the race.

RAC311.5 Any racing authority or breed registry ruling involving horses registered by AQHA or affecting personnel engaged in American Quarter Horse racing shall be filed with AQHA unless the fine is less than \$500 or the suspension is less than 90 days.

RAC311.6 AQHA, in cooperation with ARCI, can provide information on licensing, rulings and racing statistics for American Quarter Horse trainers. This information may be requested by contacting AQHA's Racing Department.

RAC312. TATTOOING AND PARENTAGE VERIFICATION.

RAC312.1 Unless otherwise stipulated by the responsible Racing Authority, every horse registered with AQHA prior to participating in an AQHA recognized race shall be identified and branded with a tattoo number on the upper lip by an AQHA-authorized tattoo technician.

RAC312.2 The official tattoo identification number shall be noted on the horse's registration certificate and become part of the identifying markings of the horse.

RAC312.3 The fee for tattoo identification by an AQHA-authorized tattoo technician is payable at the time of tattoo identification.

RAC312.4 The tattooing of an identification number on a horse is another means of identification only and, in no event, constitutes a waiver by AQHA of its authority to correct and/or cancel a registration certificate for cause under AQHA's rules and regulations.

RAC312.5 In order to be eligible to be tattoo identified, all horses foaled on or after January 1, 1992 shall be parentage verified through genetic testing. The horse's registration certificate shall be issued or reissued designating that the horse has been parentage verified. Payment of all fees, as specified in FEES, for parentage verification is the expense of the owner of the horse for which tattoo identification is requested.

RAC312.6 If a horse is presented for tattoo identification with a significant discrepancy in markings, age or other features of the horse according to the registration certificate, the tattoo technician shall refuse to tattoo the horse and report such discrepancies to AQHA. Refer to REG121, for rules pertaining to age determination by tooth examination and ineligibility to compete, if age shown by teeth does not correspond with age shown on registration certificate.

RAC312.7 A horse owner's refusal to comply with the requirements regarding tattoo identification or parentage verification shall automatically disqualify such horse from participation in AQHA-approved racing until such time as the owner complies with such requirements. Such refusal is grounds for possible disciplinary action by AQHA.

RAC313. GENERAL CUTTER AND CHARIOT RACING PROVISIONS.

RAC313.1 AQHA will accept cutter and chariot race results in Amarillo, Texas, as official and use such results for purposes of recording information in AQHA records, conducting AQHA cutter and chariot racing programs and determining qualification for advancement of a horse in AQHA's breed registry.

RAC313.2 Cutter and chariot race results are eligible for AQHA recognition if the race is run under the direct supervision of a state

racing commission and/or the World Championship Cutter and Chariot Racing Association (WCCCRA).

RAC313.3 Unless otherwise specified in this rulebook, the racing rules of the WCCCRA will be utilized for the governance of cutter and chariot racing recognized by AQHA.

RAC313.4 A cutter and chariot racing contest shall consist of a series of races constituting one complete go-round for all horses entered, each race shall match two or more two-horse teams pulling a cutter and driver or a chariot and driver. For a contest to be recognized, 12 teams of registered horses (24 horses) must compete.

RAC313.5 All American Quarter Horses participating in cutter and chariot races must be properly identified.

RAC313.6 Cutter and chariot racing is a timed event, with placings determined on the basis of time lapsed for each team in the contest. The winning team in each contest will be the team with the least lapsed time between the time the starting gate opens to dispatch the horses until the nose of the leading horse on such team crosses the finish line.

RAC313.7 Officials of a cutter and chariot racing contest shall consist of a presiding steward and two associate stewards, a starter, a clerk of the scales and three timers. In the event an electronic timer is used, there must still be two hand-timers. The time for any given team will be the time electronically recorded for that team, or the average of the hand timers in the event the electronic timer is not used or fails to operate.

RAC313.8 To be eligible for placing, the aggregate weight of the cutter or chariot, harnesses, bridles and driver for such team must not be less than 275 pounds.

RAC313.9 A cutter and chariot race must be started from a closed starting gate and conducted on a straight course.

RAC313.10 During the course of a cutter and chariot race, if a team moves out of the lane in which it starts in such a manner that it interferes with or impedes another team, the offending team shall be disqualified when, in the opinion of the stewards, the outcome of the contest was affected. Any such team disqualified shall be placed behind the team or teams it fouled, and shall be given the time of the team it was placed behind, plus .01 second, or the maximum accuracy of the timer not to exceed .001 second.

RAC313.11 Any horse finishing first, and any horse randomly selected by the stewards in a cutter and chariot racing contest shall be properly tested for the presence of unauthorized drugs or foreign substances

RAC313.12 Official speed indexes and Register of Merits shall be awarded according to RAC308.

RAC313.13 High-Point Champions will be awarded at the end of the cutter and chariot racing season in the following categories: 3-year-old colt, 3-year-old filly, 3-year-old gelding, aged stallion, aged mare and aged gelding. An appropriate award will be given to the horse's recorded owner as of April 1.

RAC313.14 Superior Chariot Horse will be awarded to any American Quarter Horse who earns 200 chariot racing points.

RAC313.15 Chariot racing points will be awarded according to the order of finish in each division as listed in the chart below.

	1st	2nd	3rd	4th	5th	6th	7th	8th	9th	10th	11th	12th
Graded stakes for \$100,000 or more												
Stakes races for \$100,000 or more												
Restricted graded stakes for \$100,000 or more	20	19	18	17	16	15	14	13	12	11	10	9
Restricted stakes races for \$100,000 or more												
Graded stakes for \$50,000-\$99,999												
Stakes races for \$50,000-\$99,999												
Restricted graded stakes for \$50,000-\$99,999	19	18	17	16	15	14	13	12	11	10	9	8
Restricted stakes races for \$50,000-\$99,999												
Graded stakes for \$25,000-\$49,999												
Stakes races for \$25,000-\$49,999												
Restricted graded stakes for \$25,000-\$49,999	16	15	14	13	12	11	10	9	8	7	6	5
Restricted stakes races for \$25,000-\$49,999												
Graded stakes for \$15,000-\$24,999												
Stakes races for \$15,000-\$24,999												
Restricted graded stakes for \$15,000-\$24,999	14	13	12	11	10	9	8	7	6	5	4	3
Restricted stakes for \$15,000-\$24,999												
Allowance, Consolations, Claiming Stakes or Finals races for \$15,000 or more	14	12	10	8	6	4	2	1				
Allowance, Consolation or Finals \$3,500-\$14,999												
OR Mexico stakes races \$7,500-\$14,999	12	10	8	6	4	2	1					
OR Trials for races with purse of \$50,000 & up												
Allowance, Consolation or Finals \$2,000-\$3,499												
OR Trials for races with purse of \$25,000-\$49,999												
OR Claiming price of \$7,500 & up with purse of \$2,000 & up	10	8	6	4	2	1						
Allowance, Consolation or Finals of \$1,000-\$1,999												
OR Starter Allowance races with no specific claiming price												
OR Trials for races with purse of \$15,000-\$24,999												
OR Claiming price of \$7,500 & up with purse of \$1,000-\$1,999	8	6	4	3	2	1						
Allowance, Consolation or Finals of \$200-\$999												
OR Trials for races with purse of \$5,000-\$14,999												
OR Claiming Stakes Trials												
OR Claiming price of \$7,500 & up with purse of \$200-\$999	7	5	4	3	2	1						
OR Claiming price of \$4,000-\$7,499 with purse of \$1,000 & up												
Trials for races with purse less than \$5,000												
OR Claiming price of \$4,000-\$7,499 with purse of \$200-\$999	6	4	3	2	1							
OR Claiming price of \$2,500-\$3,999 with purse of \$1,000 & up												
Claiming price of \$2,500-\$3,999 with purse of \$200-\$999												
OR Claiming price of \$1,000-\$2,499 with purse of \$1,000 & up	5	3	2	1								
Claiming price of \$1,000-\$2,499 with purse of \$200-\$999	4	3	1									
Graded races (Speed Index, Speed Index Trial, Speed Index Final)												
OR Any Race with a purse of less than \$200	3	1										
OR Any maiden race												

Match races or races with less than 5 starters on original card; race canceled, but money paid; or race run at distance other than official AQHA distances will not receive race points.

AQHA POINTS DISTRIBUTION FOR WCCRA RACES

..... PLACE	1ST PLACE	2ND PLACE	3RD
WORLD CHAMPIONSHIP CHARIOT RACING FINALS *			
1st Division	16	10	5
2nd Division.....	12	6	3
3rd Division	10	5	3
4th Division.....	8	4	2
5th Division	6	3	2
6th Division	5	3	2
WORLD CHAMPIONSHIP QUALIFYING RACES* - 1ST DIVISION			
Two-team race	10		
Three-team race.....	10	5	
Four-team race.....	10	6	4
WORLD CHAMPIONSHIP QUALIFYING RACES* - 2ND DIVISION			
Two-team race	8		
Three-team race.....	8	4	
Four-team race.....	8	5	3
WORLD CHAMPIONSHIP QUALIFYING RACES* - 3RD DIVISION			
State Finals - 1st Division and World Chariot Challenge Day Two 1st Division			
Two-team race	7		
Three-team race.....	7	3	
Four-team race.....	7	4	2
WORLD CHAMPIONSHIP QUALIFYING RACES* - 4TH DIVISION			
State Finals - 2nd Division and World Chariot Challenge Day Two 2nd Division			
Two-team race	6		
Three-team race.....	6	3	
Four-team race.....	6	4	2
WORLD CHAMPIONSHIP QUALIFYING RACES* - 5TH DIVISION			
State Finals - 3rd Division and World Chariot Challenge Day Two 3rd Division			
Two-team race	5		
Three-team race.....	5	2	
Four-team race.....	5	3	2
WORLD CHAMPIONSHIP QUALIFYING RACES - 6TH DIVISION			
State Finals - 4th through 12th Division and World Chariot Challenge Day One; Day Two - 4th Division and Extra Teams			
Two-team race	4		
Three-team race.....	4	2	
Four-team race.....	4	3	2
HOME ASSOCIATION RACES			
Two-team race	3		
Three-team race.....	3	1	
Four-team race.....	3	2	1

*First four days of World Championships and the 1st thru next-to-last divisional races on the final day are Qualifying races. Only the last race in each division on the final day is for that division's overall winner – the winners of the last race in the 1st Division are the World Champion

2016 All World Show Rules

Youth World

Qualifying: May 1 – April 30

Entry Deadline: July 1, 2016

Show Dates: August 5 – August 13, 2016

Select World

Qualifying Dates: June 1 – May 31

Entry Deadline: August 1, 2016

Show Dates: August 26 – September 3, 2016

Open/Amateur World

Qualifying Dates: August 1 – July 31

Entry Deadline: September 15, 2016

Show Dates: November 4 – November 19, 2016

The following apply to all World Shows: Some of these rules only apply specifically to the World Shows. A more complete and detailed description of some of these rules can be found in the qualifiers Handbook for each show.

- A current AQHA membership is required of the Horse's Owner.
- Every World Champion is automatically invited to participate in the same class at the following year's World Champion Show. In the case of youth, amateur and select entries, the horse ownership must remain the same. For the Open class the horse is invited.
- All weanlings and yearlings must be parentage verified by entry deadline.
- If a horse qualifies in both halter and performance halter, he/she may be exhibited in both classes.
- All horses not officially entered in the show but assisting in cutting or team roping events must be registered American Quarter Horses. No stallions can be used as helping horses for the youth world. Also, for the youth world, contestants' horses entered in the show can only be ridden as helping horses by that contestant.
- Anyone with current AQHA or AQHYA membership may assist in heading and/or heeling.
- Exhibitors cancelling their entries for any reason other than a horse becoming severely injured or disabled or entries declared ineligible after the entry deadline shall forfeit all fees. Refunds will be granted in the case of a horse becoming severely injured, disabled or deceased with a statement from two AAEP-approved veterinarians stating the severity of the debilitating injury or illness, and lack of the probability of short-term recovery are required. No office fee(s) will be refunded. Fees for stalling, bedding, cattle charge and drug fees will be refunded. Class entry fees will be refunded if working orders have not been completed.
- International, Hawaiian and Alaska World Show qualifiers and invitees may lease and show any horse at any World Show. If the horse is qualified for a World Show, it may be shown at any World Show. Lease must be received by AQHA at entry deadline.

- Should an exhibitor's horse die that is nationally qualified, the exhibitor may substitute another horse for the deceased horse so long as all ownership and entry requirements are met. In classes where the exhibitor is being judged, the substitution may be made one hour before the class. In all other classes, the substitution must be made prior to entry deadline.
- Current 30-day original health certificates will be required on all horses, as well as an original negative Coggins test dated within 12 months of the show.
- Each exhibitor is required to present original registration certificates to the show secretary. If a horse is disqualified or receives a no time in the finals or scratches before the finals due to lameness, he/she will be considered a finalist and eligible for awards. In the finals, if a horse is excused due to lameness, he/she will not be considered a finalist and will not be eligible for awards.
- All horses including help horses will be checked for lameness prior to competing.
- If three or more judges call a horse lame, they will be disqualified.
- Attire/Logos: There are specific rules governing the use of non AQHA corporate partner/sponsor logos in qualifiers handbook.
- Points earned at Introductory shows, in EWD, Level I or Rookie classes will not count towards qualification.
- If 15 or less entries are entered in a particular class, there will not be a go-round and only the final performance will be held. In pleasure driving, if there are 12 or less entries, only finals will be held.
- In amateur weanling classes only, an immediate family member may substitute as exhibitor.

Youth World

- In halter, exhibitors must be at least 9 years of age by January 1 of the show year, except in performance halter, where the youth can be any age 18 or under.
- Each Affiliate may send four representatives or up to six representatives per class not to exceed 140 total affiliate entries.
- Qualifications for each affiliate are governed by that affiliate.
- Affiliate entries must be member of the official AQHYA affiliate and must be a member of the AQHYA by July 1 of the year of the show.
- Alternates can only replace a state qualified entry.
- Affiliates may designate an unlimited number of alternates. However, all alternates must be listed at the time of entry.

Select World

- The amateur exhibitor must be 50 years of age or older on or before entry deadline. Points earned during the qualifying time period while the age of 49 will count.
- If an amateur exhibitor is 70 years of age or older on or before entry deadline, he/she only has to earn half of the minimum of qualifying points.
- If the horse is a weanling, the ownership deadline is waived, and the weanling can be sold after the entry deadline, so long as the transfer is completed by AQHA prior to the class. However, any

weanling that is sold after the entry deadline cannot be shown at both the Select and Amateur at the World Show even with a different exhibitor.

- An invitation will be sent to the highest point-earning horse/exhibitor combination that missed reaching the minimum number of points set by AQHA to qualify in each class from each state or province and has earned at least one-half of the minimum number of points.
- The same horse/exhibitor combination is not eligible to compete in the same class(es) at the Select World show and the corresponding Amateur class(es) at the AQHA World Championship show.
- In tie-down roping, there will be a 75 second time limit.

Open and Amateur World

- If the horse is a weanling, the ownership deadline is waived in both the Amateur and Open divisions, and the weanling can be sold after the entry deadline; however, the weanling must have been entered prior to the entry deadline. Ownership may change up to 24 hours prior to the class. No weanlings can have been shown at the Select World and the Amateur division at the World Show in the same year, even with a different exhibitor. Payouts for weanlings will be sent to the owner at the time the class takes place.
- An amateur invitation will be sent to the highest point-earning horse/exhibitor combination that missed reaching the minimum number of points set by AQHA to qualify in each class from each state or province and has earned at least one-half of the minimum number of points. Any ties for the highest point-earning horse/exhibitor combination will also be invited.
- For classes to count toward all-around or super horse eligibility, the exhibitor/horse must have earned a national qualification in those Level 3 classes. A class entered as an invitee or Level 2 class will not count toward all-around or super horse tabulation.
- If an exhibitor/horse is qualified and eligible in Level 3 and Level 2, they may enter and compete in both levels.
- Neither the horse nor exhibitor can show down in Level 2 if either one is ineligible as a Level 2 participant. In that case, they must earn at least the minimum number of points to qualify in Level 3 only.
- In the open division, exhibitor changes must be made by 5 p.m. the day before the class and working orders will be posted the evening before the class.
- For finals classes in the open division, exhibitor changes will be allowed only if the original exhibitor is unable to compete due to verified injury or is unable to compete due to emergency circumstances beyond the exhibitor's control.

This index contains entries for frequently utilized topics.
Specific rules are referenced, followed by page number in bold.

A

- Absolute Responsibility, VIO250; **39**
- Achievement Awards, RAC310; **292**, SHW805; **272**
- Accounts, Auditing of, Bylaws; **17**
- Advancement, REG104; **56**
- Affiliates, State/Provincial Assoc., GENI2I; **30**, VIO500; **48**
- Age of Horse, REG12I; **70**, REG127; **74**
- All-Around Trophy, SHW803; **270**
- Amateur
 - All-Around Trophy, SHW803; **270**
 - Card, GENI16; **28**
 - Champion, SHW807; **274**
 - Eligibility, SHW225; **97**
 - Fee, FEE11I; **34**
 - Grand Champion Trophy, SHW80I; **270**
 - Membership, GENI16; **28**
 - Performance Champion, SHW81I; **275**
 - Register of Merit, SHW802; **270**
 - Reserve Year-End All-Around High-Point, SHW815; **277**
 - Select, SHW225.2, **97**
 - Show Approval, SHW117; **86**
 - Superior All-Around, SHW804; **272**
 - Superior (Event) Horse, SHW810; **275**
 - Supreme Champion, SHW809; **275**
 - Supreme Performance Champion, SHW812; **275**
 - Versatility Award, SHW806; **274**
 - Year-End All-Around High-Point, SHW815; **277**
 - Year-End High-Point Horse SHW813; **275**
- Amendments, Bylaws; **7**; GENI03; **25**
- Animal Welfare Policy Statement, VIO200; **36**, RAC31I; **294**, SHW205; **94**
- Appeal, Disciplinary, VIO505; **48**
- Appendix Certificate, REG105; **57**
- Approval of Shows, SHW100; **77**
- Approved Judges, SHW900-915; **279-283**
- AQHA Champion, SHW807; **274**
- AQHA Performance Champion, SHW81I; **275**
- AQHA Reserve Year-End All-Around High-Point, SHW815; **277**
- AQHA Superior All-Around, SHW804; **272**
- AQHA Superior (Event) Horse, RAC310; **292**, SHW810; **275**
- AQHA Supreme Champion, SHW809; **275**
- AQHA Year-End All-Around High-Point, SHW815; **277**
- AQHA Year-End High-Point Horse, SHW813; **275**
- AQHYA - American Quarter Horse Youth Association, Bylaws; **19**
- AQHYA
 - All-Around, SHW803; **270**
 - Champion, SHW807; **274**
 - Eligibility, GENI15; **27**, FEE11I; **34**, SHW235; **99**
 - Grand Champion, SHW80I; **270**
 - Novice Eligibility, SHW245, **100**
 - Performance Champion Award, SHW81I; **275**
 - Register of Merit, SHW802; **270**
 - Reserve Year-End All-Around High-Point, SHW815; **277**
 - Show Approval, SHW118; **86**
 - Superior All-Around, SHW804; **272**

Superior (Event) Horse, SHW810; **275**
Supreme Champion, SHW809; **275**
Supreme Performance Champion, SHW812; **275**
Versatility Award, SHW806; **274**
Year-End All-Around High-Point Horse, SHW815; **277**
Year-End High-Point Award Horse, SHW813; **275**
World Show, **299**
Artificial Insemination, REG111; **62**
Attire, SHW320; **113**
Auction, REG124.4.2; **72**
Auditing of Accounts, Bylaws; **17**
Authorizations, REG126; **73**
Awards, RAC310; 292, SHW800; **270**

B

Bank of America - Racing Challenge, RAC307; **290**
Barrel Racing, SHW700; **248**
Bits, English - SHW310; **111**
Bits, Western, SHW305; **107**
Bonus Earning, RAC303; **286**
Brands, REG123; **71**
Breakaway Roping, SHW528; **201**
Breeder, REG113; **64**
Breeder's Certificate, REG113; **64**
Breeding Report, REG110; **62**
Bylaws, AQHA, Bylaws; **7**

C

Cala, SHW791; **269**
Campdrafting, SHW792; **269**
Certificate
Appendix, REG105; **57**
Cancellation, VIO630; **50**
Correcting, REG117; **68**
Duplicate, REG120; **70**
Numbered, REG104; **56**
Re-registration, REG116; **68**
Replacement, REG119; **69**
Challenge - Bank of America Racing, RAC307; **290**
Champion Race Horses, RAC310; **292**
Changing a Horse's Name, REG118; **69**
Chariot Racing, RAC313; **295**
Claiming Race - Transfer of Ownership, REG124.6; **72**
Clothing, SHW320; **113**
Colors - Horses; REG114; **65**
Committees, GEN100; **24**
Conduct - Prohibited, VIO100; **35**
Cooled Transported Semen, REG111; **62**
Cowboy Mounted Shooting, SHW750; **251**
Cryptorchid Condition, REG104.2; **57**, REG109; **59**
Curb Bits, SHW300; **106**
Cutter and Chariot Racing, RAC313; **295**
Cutting, SHW500; **178**

D

DNA Testing (genetic testing), REG108; **58**
Dally Team Roping, SHW529; **202**

Dam of Distinction, RAC310; **293**
Death of a Horse, REG127; **74**
Director at Large, Bylaws; **11**
Director - Emeritus, Bylaws; **10**
Directors - Elected, Bylaws; **9**
Double Judged Classes, SHW108; **79**
Dressage, SHW680; **246**
Drugs, VIO300; **40**
Duplicate Certificate, REG120; **70**

E

Earnings, RAC303; **286**
Eligibility
Amateur, SHW225; **97**
Registration, REG100; **54**
Youth, SHW235; **99**
Embryo/Oocyte Transfer, REG112; **63**
English Bits/Equipment, SHW310; **111**
Enhancement of Penalty, VIO640; **50**
Entry Fees, SHW123; **89**
Equestrians with Disabilities, SHW760; **252**
Equipment, SHW300; **106**
Equitation On the Flat, SHW616; **234**
Equitation Over Fences, SHW645; **242**
Excessive White Markings, REG109; **59**
Executive Committee, Bylaws; **14**
Executive Vice President, Bylaws; **16**
Extraordinary Registration, REG107; **58**

F

Fax, GEN124; **32**
Fees, FEE100; **33**
Membership, FEE111; **34**
Registration, FEE112; **34**
Fines, VIO640; **50**, SHW126; **90**
Fraudulent Practices, VIO100; **35**
Free Corrections, REG117; **68**
Frozen Embryo Permit, REG112; **63**
Frozen Semen, REG111; **62**

G

Gaits, SHW330; **114**
Geldings, REG122; **71**
General Notice Procedure, GEN123; **31**
General Rules & Regulations, GEN100; **24**
Genetic Defects and Undesirable Traits, REG109; **59**
Genetic Testing, REG108; **58**, RAC312; **295**
Group Halter Classes, SHW351; **121**

H

Halter Classes, SHW350; **120**
Halter Classes - Group, SHW351; **121**
Halter/Performance Halter, SHW365; **122**
Hearing, VIO600; **49**
Honorary Membership, GEN119; **29**
Honorary Vice President, Bylaws; **11**
Horse Sold Without Papers, REG127; **74**

Horse's

- Age, REGI2I; **70**
 - Death, REGI27; **74**
 - Name Change, REGI18; **69**
 - Name, REGI03; **56**
 - Colors, REGI14; **65**
 - Markings, REGI15; **66**
 - Welfare, **2**, VIO200; **36**, RAC3II; **294**, SHW205; **94**
- Horsemanship SHW430; **138**
- Horses Ineligible for Registration, REGI06; **58**
- Hunter Hack, SHW625; **238**
- Hunter Under Saddle, SHW60I; **233**
- HYPP (Hyperkalemic Periodic Paralysis), REGI09; **60**

I

- Identification Tattooing, FEEI14; **34**, RAC3I2; **295**
- Indemnification, Bylaws; **17**
- Individual Membership, GENI14; **27**, FEEI11; **34**
- Inhibiting Competition, VIO230; **38**
- Inhumane Treatment, VIO200; **36**
- Insemination, REGI11; **62**
- Inspections, SHWI20; **88**
- International Associations, GENI22; **30**
- International Directors, Bylaws; **11**
- International Performance Events, SHW790; **269**

J

- Judges, SHW900; **279**
- Jumping, SHW656; **244**
- Junior Classes, SHW400; **128**
- Junior Horses, SHWI12.6; **83**

L

- Lameness, SHW325; **113**
- Leased Horses SHW240; **99**
- Leases, REGI25; **74**, RAC304; **73**
- Legal Catches, SHW522; **199**
- Leveling, SHWI13; **84**, SHW250; **102**
- Life Membership, GENI17; **28**

M

- Manager - Show, SHWI28; **91**
- Markings of Horses, REGI15; **66**
- Membership, GENI04; **25**
 - Fees, FEEI00; **34**
 - Full Membership, Individual, GENI14; **27**
 - AQHYA (Youth) Membership, GENI15; **27**
 - Amateur Membership, GENI16; **28**
 - Life Membership, GENI17; **28**
 - Voting Privileges, GENI18; **29**
 - Honorary Membership, GENI19; **29**
- Metric Table, **269**
- Mission Statement; **1**

N

- Name Change - Horse, REGI18; **69**
- Naming a Horse, REGI03; **56**

Notice of Hearing, VIO600; **49**
Numbered Certificates, REGI04; **56**

O

Officials - Show, SHWI27; **90**
Officers, Bylaws; **16**
Oocyte/Embryo Transfer, REGI12; **63**
Open Versatility Award, SHW806; **274**
Order of Competition, SHWI12; **83**
Ownership, RAC304; **286**

P

Parentage Verification (see genetic testing)
Parrot Mouth Condition, REGI09; **60**
Past President(s), Bylaws; **10**
Pasture Breeding, REGI10; **62**
Photo Instructions, **66**
Pleasure Driving, SHW610; **234**
Points
 Racing, RAC309; **292**
 Shows, SHW261; **105**
Pole Bending, SHW703; **249**
Policy Statement, **2**
Premium Lists, SHWI21; **88**
President, Bylaws; **16**
Prohibited Assistance, VIO240; **39**
Prohibited
 Artificial Appliance, VIO320; **41**
 Drug, VIO300; **40**
 Medication, VIO300; **40**
 Surgical Procedure, VIO320; **41**

R

Racing
 Awards, RAC310; **292**
 Bonus Earnings, RAC303; **286**
 Champions - Regional, RAC310; **293**
 Champion - World, RAC310; **292**
 Claiming Race - Transfer of Owners, REGI24; **72**
 Cutter and Chariot Racing, RAC313; **295**
 Disciplinary Actions, RAC311; **294**
 Leases, RAC304; **286**
 Bank of America® Racing Challenge, RAC307; **290**
 Ownership, RAC304; **286**
 Race Points, RAC309; **292**
 Race Recognition, RAC301; **284**
 Race Results, RAC301; **284**
 Register of Merit, RAC310; **292**
 Rules and Regulations, RAC300; **284**
 Speed Index, RAC308; **290**
 Stakes Race, RAC306; **288**
 Superior Race Horse, RAC310; **293**
 Supreme Race Horse, RAC310; **293**
 Tattooing, RAC312; **295**
 Time Trials, RAC305; **287**
Ranch Conformation, SHW566; **232**
Ranch Cutting, SHW565; **231**

Ranch Riding, SHW416; **131**
Ranch Sorting, SHW547; **208**
Ranch Trail, SHW561; **216**
Reciprocity, VIO700; **52**
Re-registration - Certificate, REG116; **68**
Records, GENI20; **29**
Register of Merit, RAC310.9; **294**; SHW802; **270**
Registration Rules & Regulations, REG100; **54**
Reining, SHW480; **159**
Replacement Certificate, REG119; **69**
Reserve Year-End All-Around High-Point, SHW815; **277**
Responsible Party, VIO250; **39**
Responsibility for Safety, SHW210; **94**
Ribbons, SHW125; **90**
Ring Steward, SHW131; **92**
Romal, SHW305.6; **108**
Roping Events, SHW520; **199**
Rule Violations, VIO100; **35**

S

Sanction, VIO510; **49**
Scars, REG123; **71**
Secretary - Show, SHW130; **92**
Select, SHW225.2, **97**
Seller, REG124; **72**
Senior Classes, SHW400; **128**
Senior Horses, SHW112.7; **83**
Show
 Approval, SHW100; **77**
 Date/location change, SHW107; **79**
 Manager, SHW128; **91**
 Officials, SHW127; **90**
 Results, SHW126; **90**
 Rules and Regulations, SHW100-915; **77**
 Secretary, SHW130; **92**
 Therapeutic Medication Addendum, VIO400; **42**
 Types of Shows, SHW108; **79**
Showmanship at Halter, SHW370; **123**
Snaffle Bits, SHW305; **107**
Spayed Mares, REG122; **71**
Special Achievement Recognition, SHW817; **277**
Speed Index, RAC308; **290**
Stake Racing, SHW710; **250**
Stakes Races, RAC306; **288**
Stallion Breeding Report, REG110; **62**
Stallion Owner, REG110; **62**
Stallions Prohibited, SHW215.9; **96**
Standing Committees, GEN100; **24**
State/Provincial Affiliates, GEN121; **30**, VIO500.2; **48**
Statement of Position, **2**
Stewards, SHW133; **93**
Stud Book, REG100; **54**
Superior All-Around, SHW804; **272**
Superior (Event) Horse, SHW810; **275**
Superior Race Horse, RAC310.5; **293**
Supreme Champion Award, SHW808; **274**
Supreme Race Horse, RAC310.6; **293**

Surgical Procedure, VIO320; **41**
Suspension, VIO500; **48**
 Temporary, VIO610; **50**
 Effect of Membership, VIO650; **50**
 Effect on Privileges in Events, VIO655; **51**
 Racing Disciplinary Action, RAC311; **294**
Syndicates, REG126; **73**

T

Tattooing, RAC312; **295**
Team Penning, SHW540; **204**
Temporary Suspension, VIO610; **50**
Teeth Examination, REG121; **71**
Testing, RAC311; **294**, SHW120; **88**
Therapeutic Medication Addendum, VIO400; **42**
Thoroughbreds, REG102; **55**, REG110; **62**
Time Trials, RAC305; **287**
Ties, SHW124; **89**
Tie-down Roping, SHW525; **199**
Track and World Records, RAC310.7; **293**
Trail, SHW461; **155**
Transfer of Ownership, REG124; **72**
Treasurer, Bylaws; **16**
Types of Shows, SHW108; **79**

U

Unsportsmanlike Conduct, VIO220; **38**

V

Versatility Award, SHW806; **274**
Versatility Ranch Horse, SHW550; **209**
 Ranch Conformation, SHW566; **232**
 Ranch Cutting, SHW565; **231**
 Ranch Riding, SHW560; **214**
 Ranch Trail, SHW561; **216**
Veterinarian, SHW132; **93**
Vice President, Bylaws; **14**
Violations, VIO100; **35**
Voting, GEN118; **29**

W

Walk/Trot, SHW755; **251**
Welfare of Horse, **2**, VIO200; **36** RAC311; **294**, SHW205; **94**
Western, Bits/Equipment, SHW300; **106**
Western Horsemanship, SHW430; **138**
Western Pleasure, SHW402; **130**
Western Riding, SHW451; **143**
White Markings, REG109; **61**, REG115; **66**
Working Cow Horse, SHW505; **179**

Y

Year-End All-Around High-Point, SHW815; **277**
Year-End High-Point, SHW813; **275**
Youth (see AQHYA)

UNSPOKEN



STRAWBERRY SNAILS PHOTOGRAPHY

The moment you swing into the saddle, you connect with him in a language more powerful than words. You share a silent bond of trust; you keep him safe, and he gives you freedom. The relationship between horse and rider is a unique one – one that we understand.

That's why we created the Horseback Riding Program. All breeds can participate, and we reward you with gear, tack, and clothing for doing what you love – riding!

Enroll today at aqha.com/hbr for just \$35
Maintain your AQHA membership and log your hours in the saddle



WESTERN CIVILIZATION

Sure, he can put the smack-down on an unruly cow or shred a barrel pattern like nobody's business. But underneath the tough exterior, the American Quarter Horse is a polished gentleman capable of delicate trail work, flowing reining maneuvers and everything in between. Think of him as silk meets sledgehammer.



The American Quarter Horse Association has a variety of options for members wishing to compete at all levels. Find an AQHA-approved event, learn more about the leveling program, upgrade to an Amateur membership and much more.

Visit aqha.com today.

AQHA

   Instagram



It's Your **Horse,**
Your **Passion,**
Your **Incentive**
Fund.

AQHA

INCENTIVE FUND

When a show ends, we think the winning stops. But with the AQHA Incentive Fund, rewards keep rolling in well after show season.

From buying that new saddle you've had your eye on to paying for entry fees or purchasing equine insurance and horse-health products, the possibilities are endless once you get that Incentive Fund check in the mail.

The AQHA Incentive Fund pays back to the stallion nominators, foal nominators and owners of the competing horses.

More than \$75 million has been paid out since the Incentive Fund's inception.

Owner, exhibitor and breeder feedback has driven changes to the Incentive Fund. To make the program more beneficial to all competitors, effective January 1, 2016, competition licenses will no longer be required; and the point cap will be adjusted.

Learn more at
aqha.com/incentivefund.



#MyAQHAIncentive