

Reining-Pattern:

LK 1/2 B : #1

LK 1/2 A junior : #5

LK 1/2 A senior : #7

LK 3 A/B : #6

LK 4 A/B : #2

Western Riding:

LK 1/2 A/B : #2

LK 3 : #6

Superhorse:

LK 1/2 A/B : #1

Jungpferde Basis : #1

EWU-A/C Turnier - Walters Horse Paradies - Hawangen
alle SSH

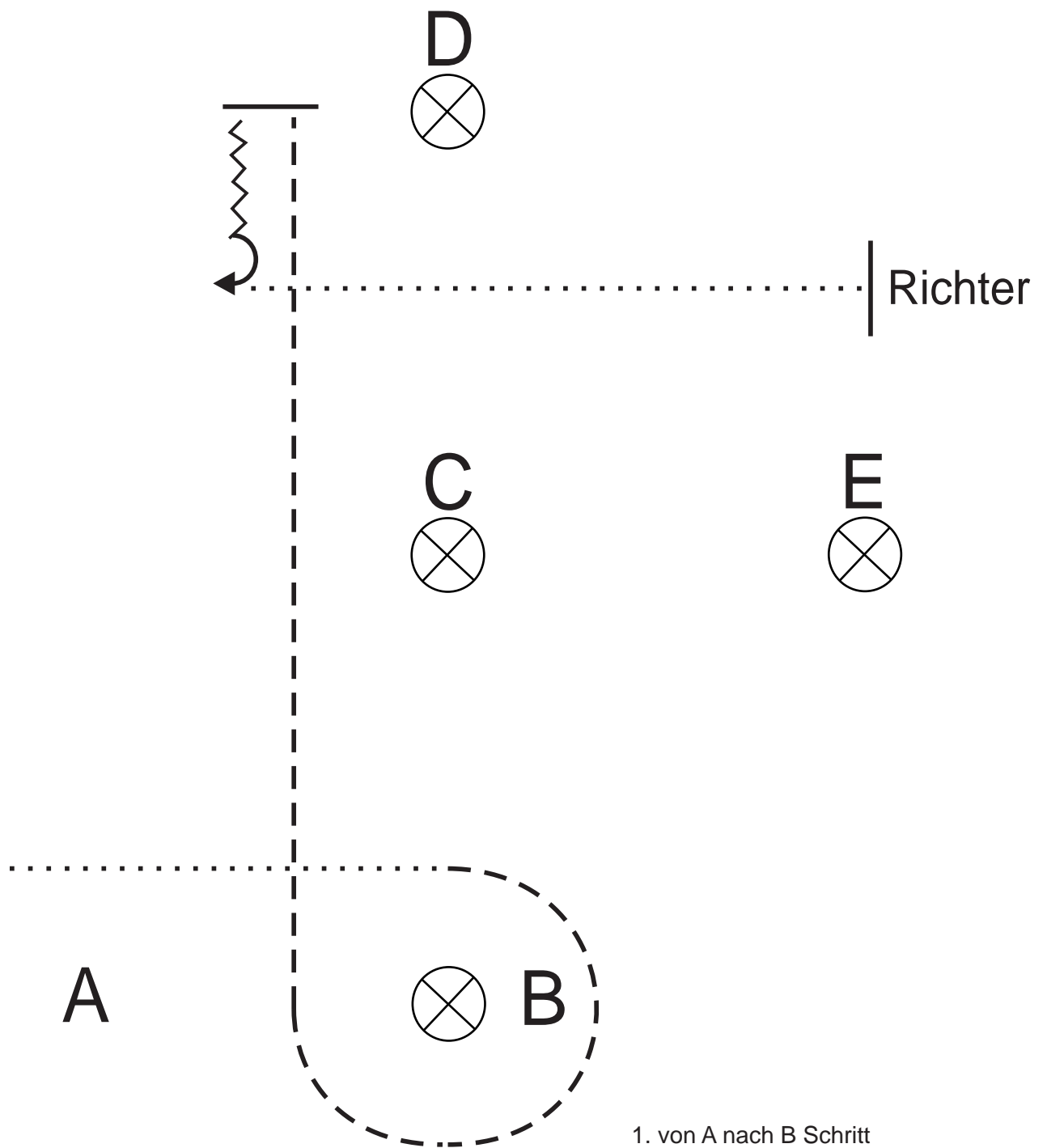

1. von A nach B Schritt
2. um B nach D Trab
3. Rückwärts richten
4. 90° HHW rechts
5. im Schritt bis zum Richter
6. SetUp
7. im Trab zum LineUp

| | | | |
|--|--------|---|------------|
|  | Marker |  | Walk |
| | |  | Jog |
| | |  | Lope |
|  | Brücke |  | Back Up |
| | |  | ext. Trott |

Pattern © 2011 PVNS
<http://www.asjacky.de>
 Nachdruck nur mit Genehmigung

WHS LK 1/2 A/B

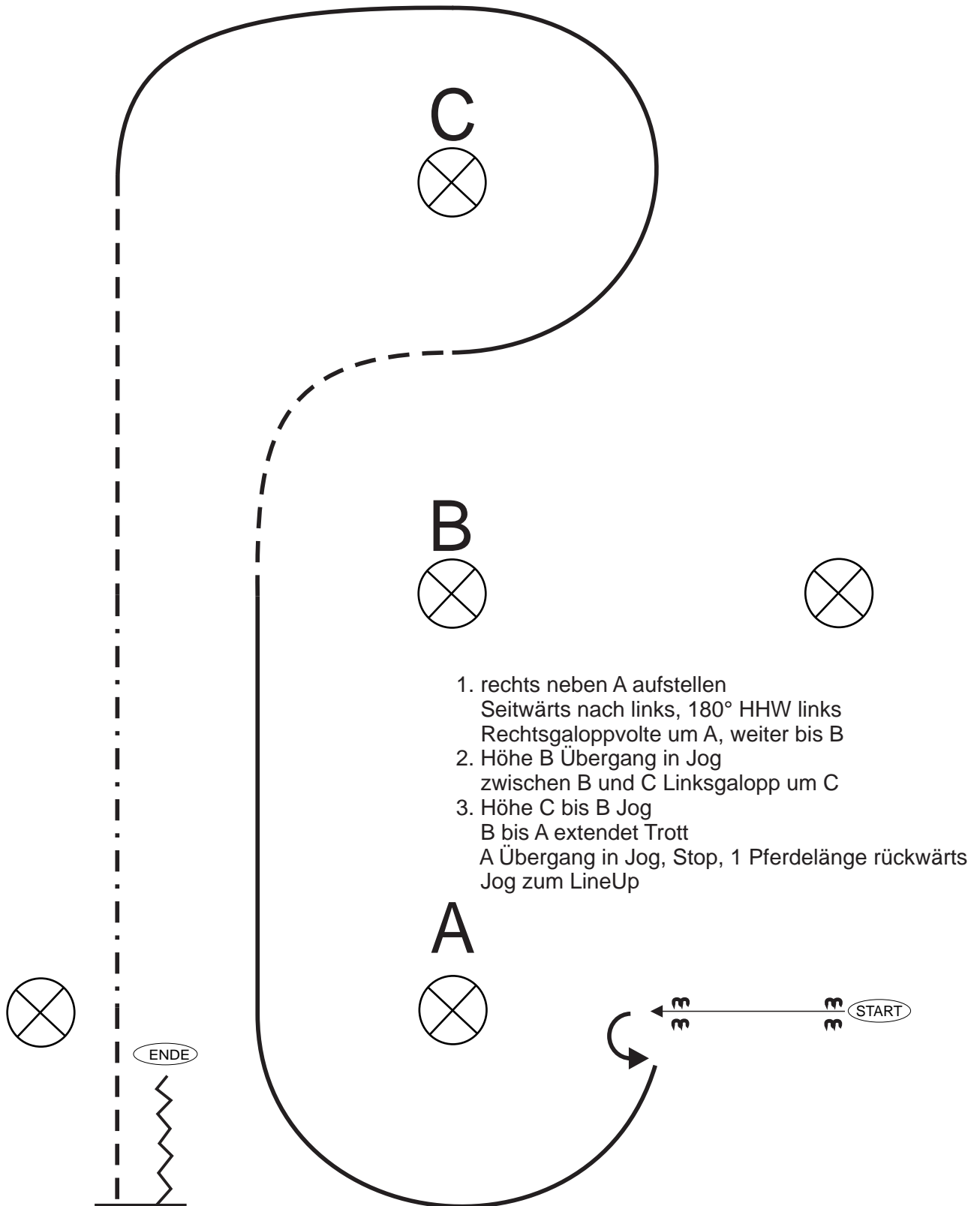

| | | | |
|--|--------|--|------------|
| | Marker | | Walk |
| | Brücke | | Jog |
| | | | Lope |
| | | | Back Up |
| | | | ext. Trott |

WHS LK 4/5 A/B

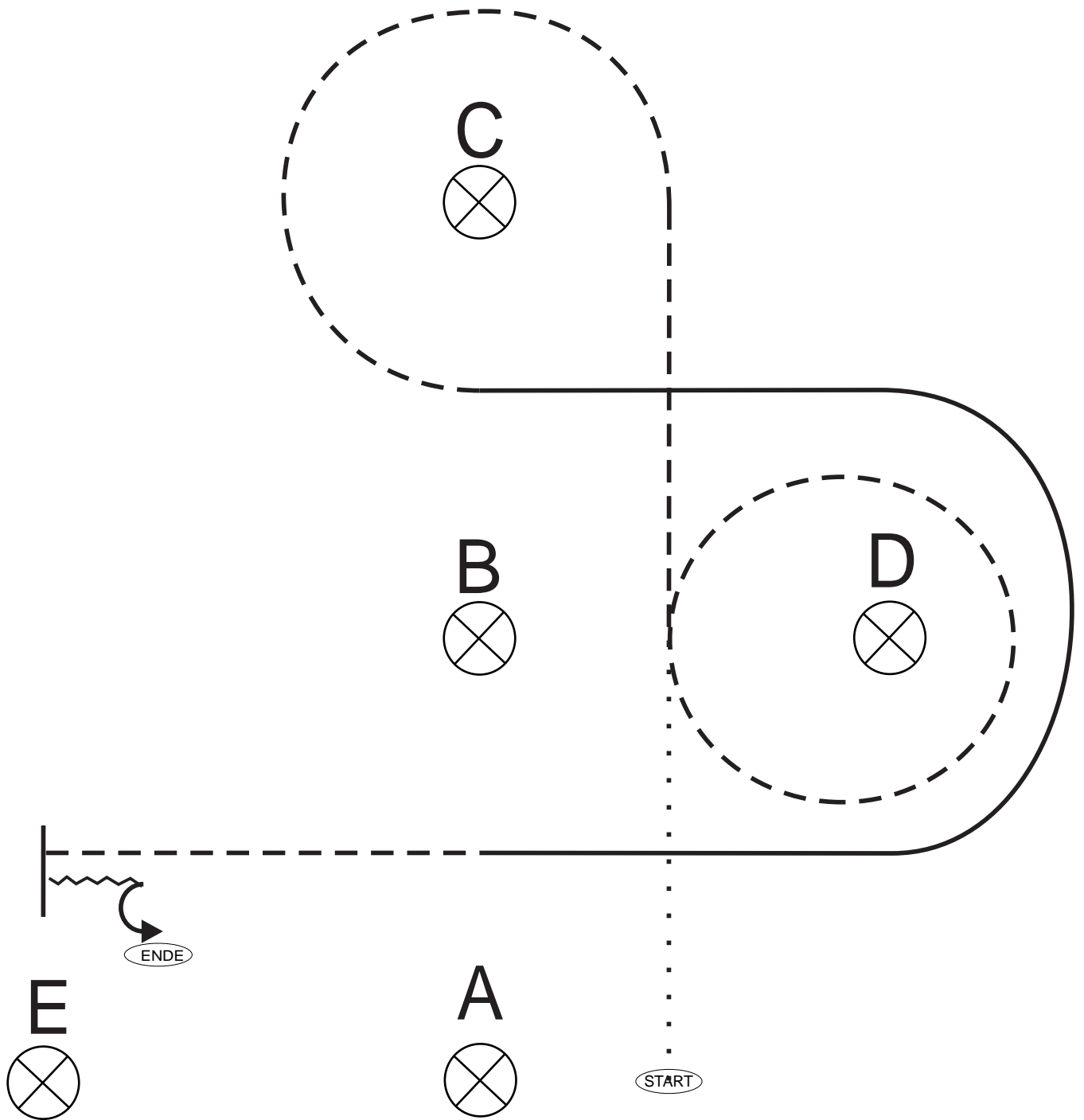

1. A bis D Schritt, Trabzirkel um D
2. Trab bis C, Zirkel um C, zwischen B und C Übergang in Rechtsgalopp, Zirkel um D
3. zwischen A und B Übergang in Trab, Trab bis E, Stop, 1 Pferdelänge rückwärts, 90° HHW links, im Schritt zum LineUp



Marker



Brücke



Walk



Jog



Lope



Back Up



ext. Trott

Pattern © 2011 PVNS

<http://www.asjacky.de>

Nachdruck nur mit Genehmigung

WHS LK 3 A/B

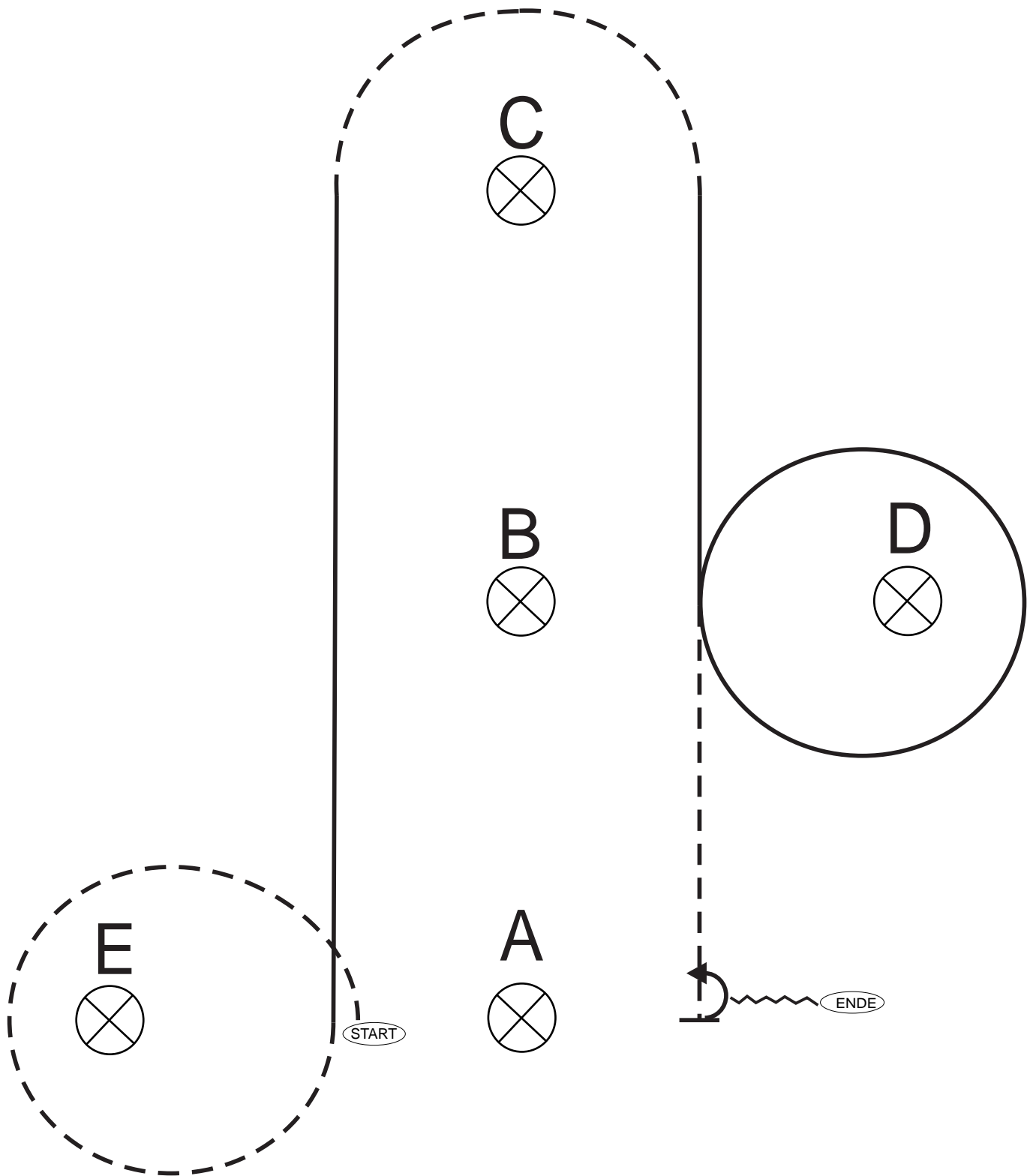

1. Trabvolte um E, Rechtsgalopp bis C
2. Trabvolte um C, C bis D Linksgalopp, um D Linksgaloppvolte
3. zwischen D und B Übergang in Trab, Trab bis A, Stop, 270° HHW links, 1 Pferdelänge Rückwärts, Trab zum LineUp



Marker



Brücke



Walk



Jog



Lope



Back Up



ext. Trott

Pattern © 2011 PVNS

<http://www.asjacky.de>

Nachdruck nur mit Genehmigung

EWU-A/C Turnier - Walters Horse Paradies - Hawangen
TH LK 1/2 A/B sen.

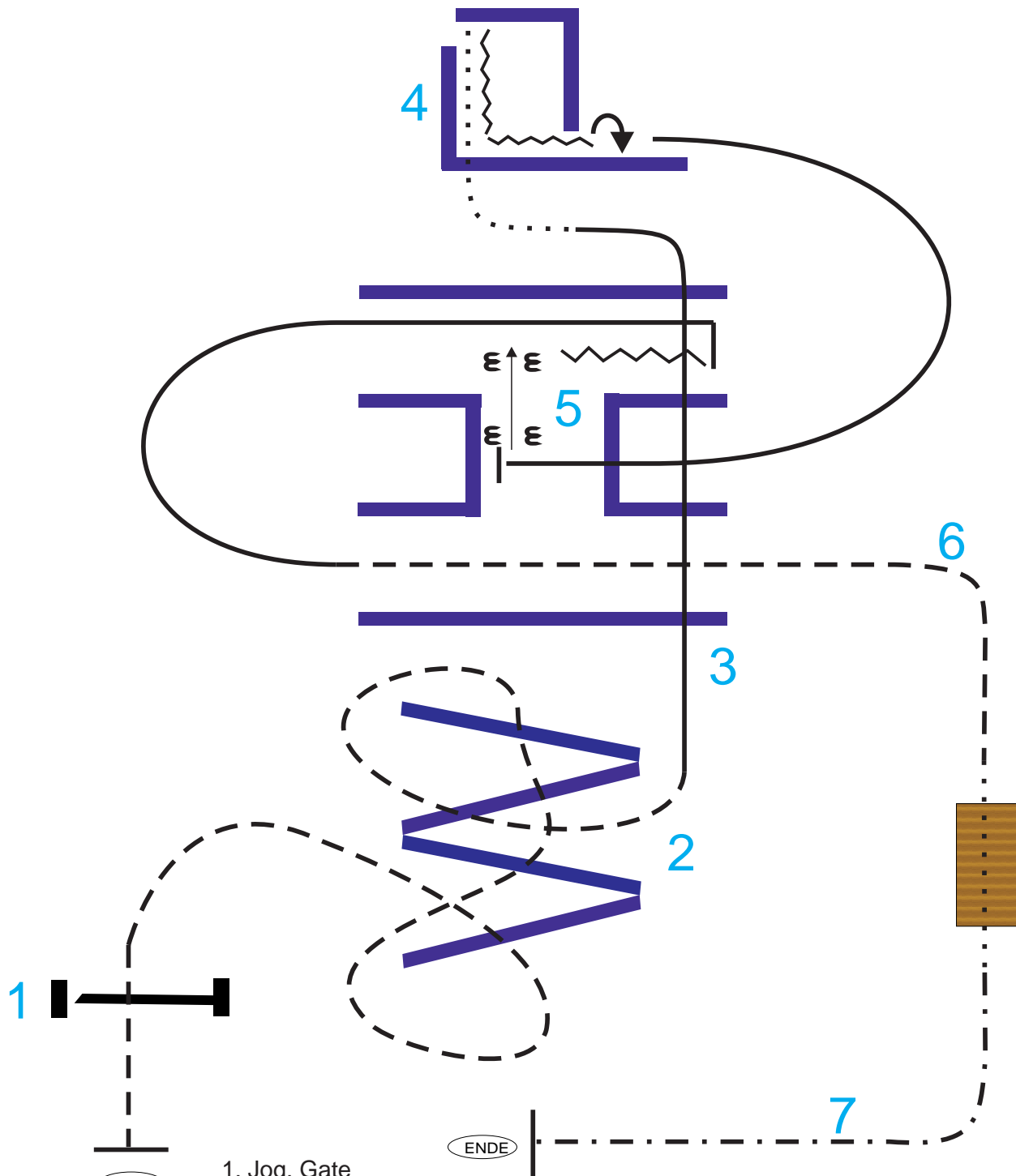

1. Jog, Gate
2. Jog over
3. Lope over left lead
4. Walk in, BackUp, Turn 180° right
5. Lope in right lead, Sidepass right, Backup
6. Lope out left lead, Jog through, walk over bridge
7. extendet trott, stop

⊗ Marker

▒ Brücke

- ⋯ Walk
- - - Jog
- Lope
- ⚡ Back Up
- · - · - ext. Trott

Pattern © 2011 PVNS

<http://www.asjacky.de>

Nachdruck nur mit Genehmigung

EWU-A/C Turnier - Walters Horse Paradies - Hawangen
TH LK 3 & 1/2 A/B jun.

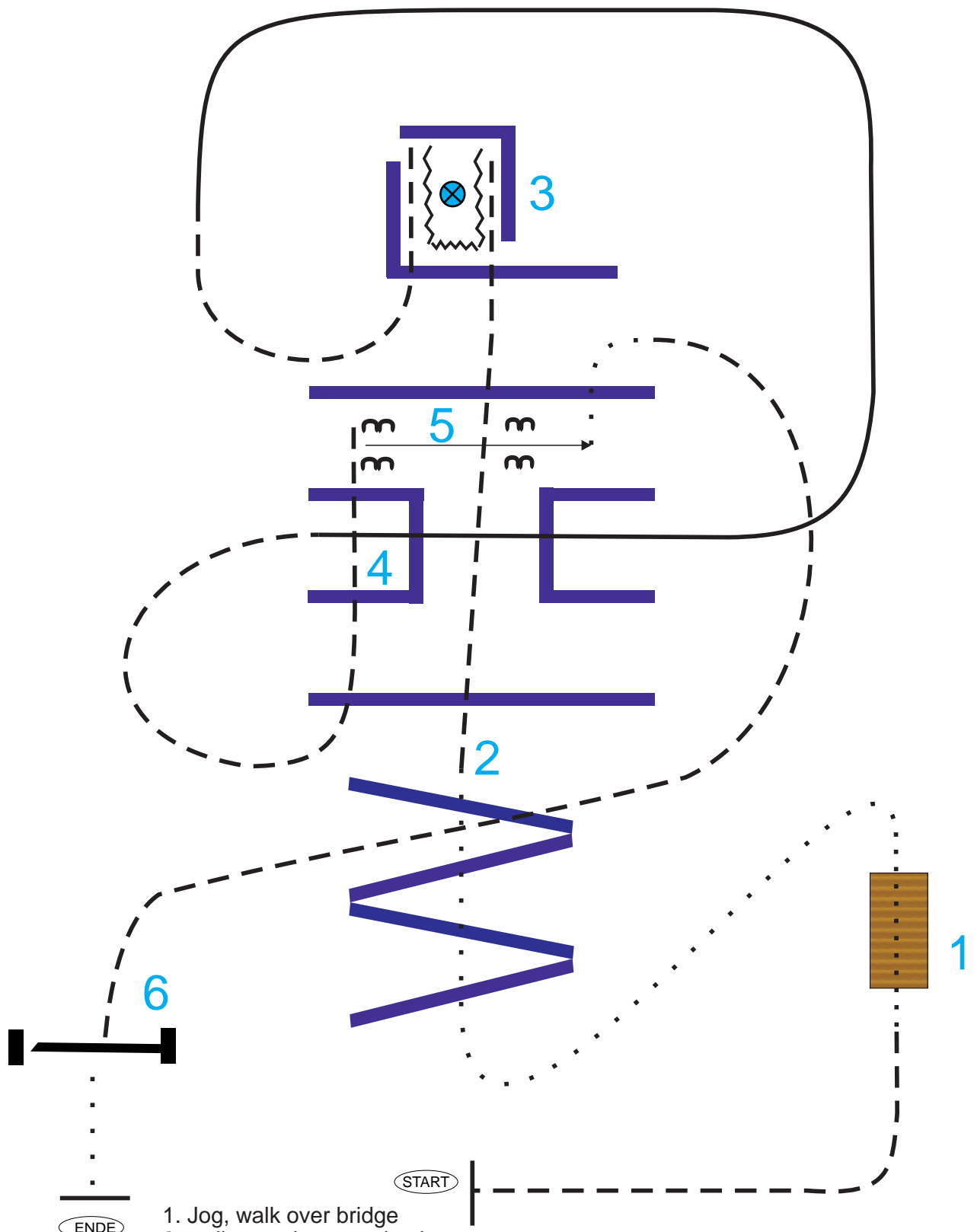

1. Jog, walk over bridge
2. walk over, jog over, jog in
3. backup, jog out
4. lope over right lead, jog over
5. sidepass right, walk out
6. jog over, gate, walk, stop

| | | | |
|--|--------|--|------------|
| | Marker | | Walk |
| | Brücke | | Jog |
| | | | Lope |
| | | | Back Up |
| | | | ext. Trott |

Pattern © 2011 PVNS
<http://www.asjacky.de>
 Nachdruck nur mit Genehmigung

EWU-A/C Turnier - Walters Horse Paradies - Hawangen

TH LK 4 A/B

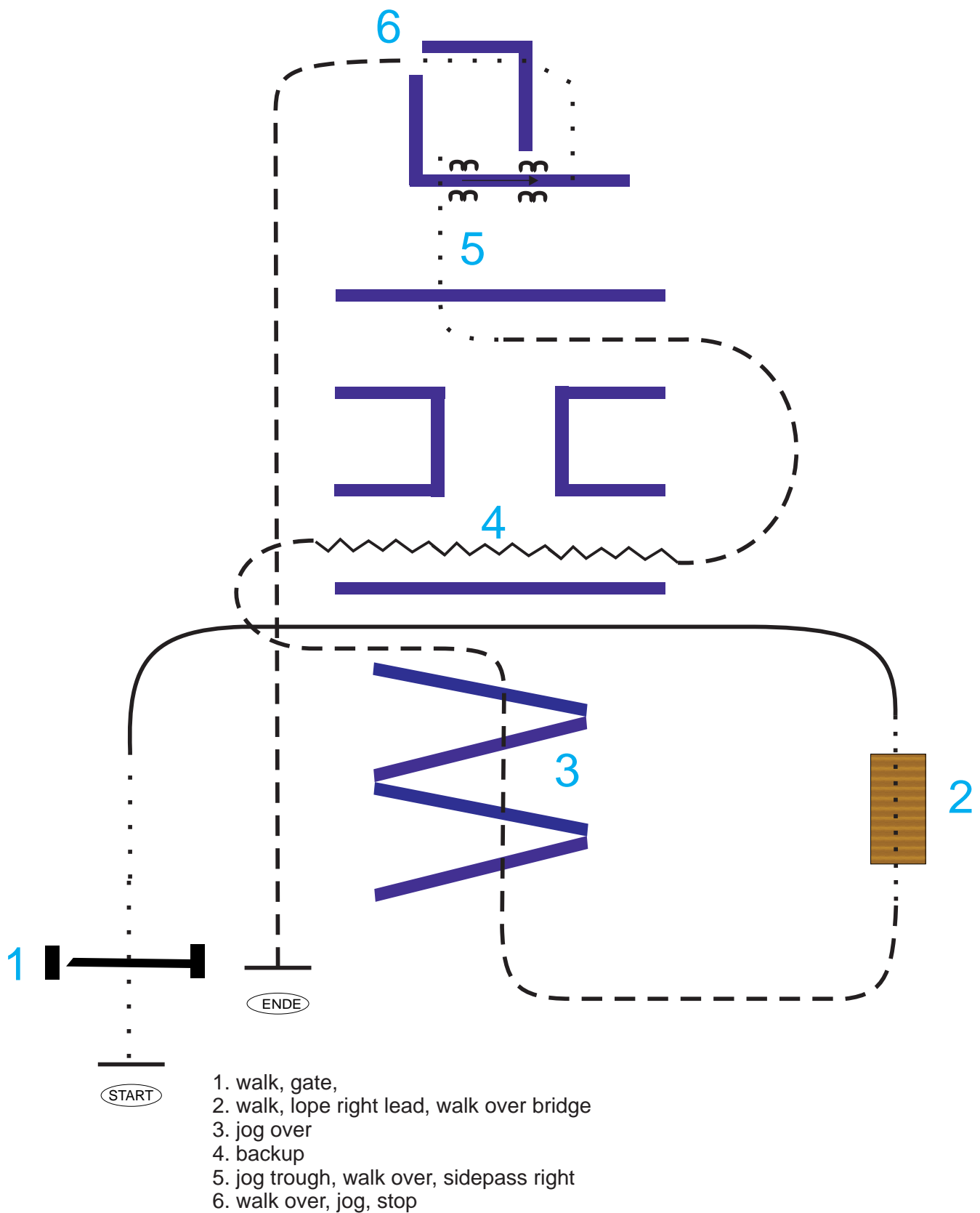

Marker



Brücke

..... Walk

----- Jog

~~~~~ Lope

~~~~~ Back Up

----- ext. Trott

Pattern © 2011 PVNS

<http://www.asjacky.de>

Nachdruck nur mit Genehmigung

EWU-A/C Turnier - Walters Horse Paradies - Hawangen
TH LK 5 A/B

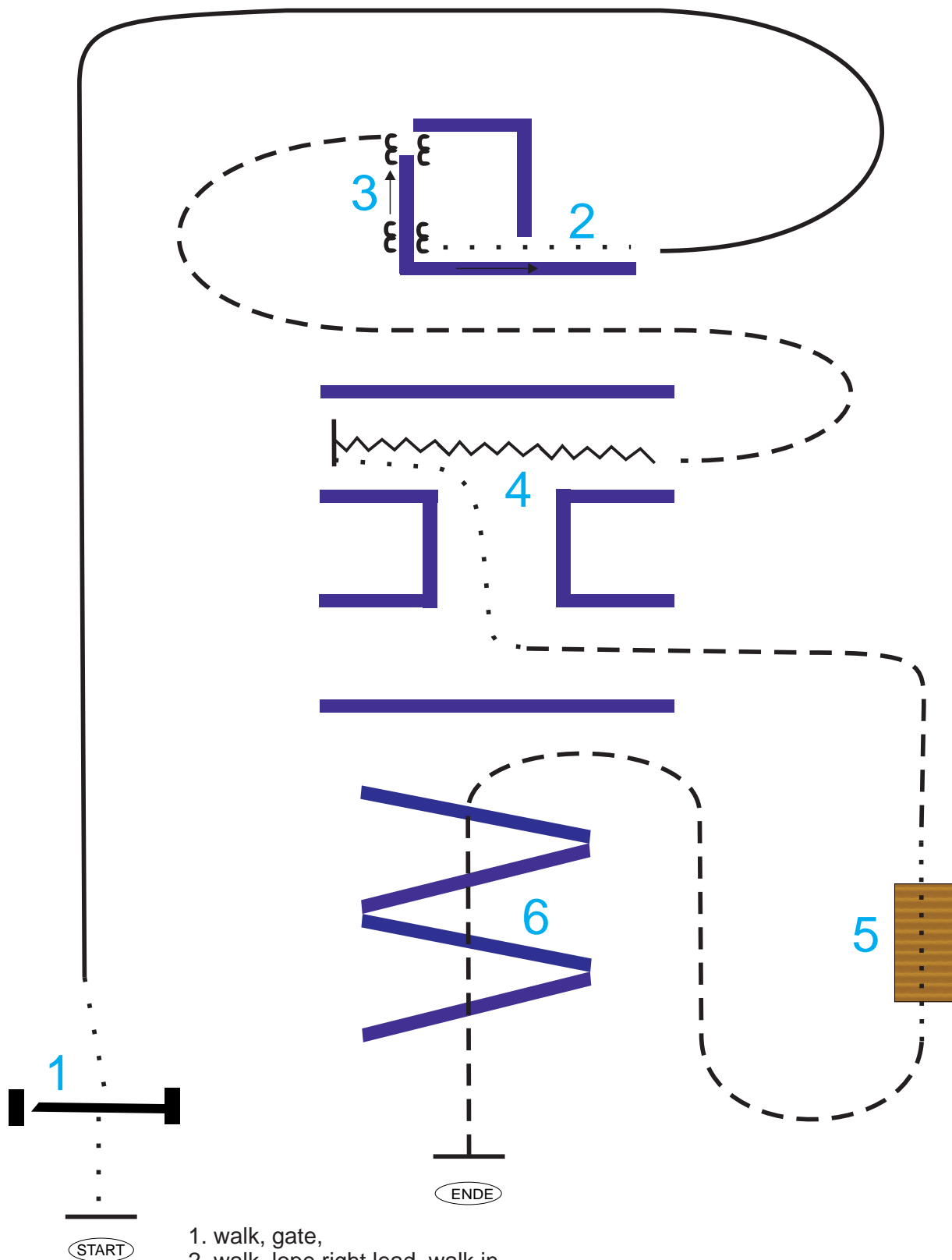

1. walk, gate,
2. walk, lope right lead, walk in
3. sidepass right
4. jog, backup, walk, jog out
5. walk over bridge
6. jog over, stop

⊗ Marker

▒ Brücke

- ⋯ Walk
- - - Jog
- ⚡ Lope
- ⚡ Back Up
- · - · - ext. Trott

Pattern © 2011 PVNS

<http://www.asjacky.de>

Nachdruck nur mit Genehmigung